



*The industry's only employee owned company*

# New This Year Recreational Ponds

Pages 40-43

# 2025

## Pond and Water Feature Catalog



**Water Garden &  
Koi Pond Products**

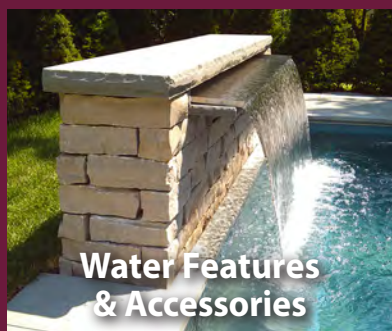

**Water Features  
& Accessories**



**Water  
Treatments**



**Formal Fountains  
& Accessories**

**800-448-3873**

**EASYPRO.COM**



# From the Owners



SINCE 1970

2024 was our team's first year as an employee-owned company. It was an exciting year full of positive changes as every individual in the company embodied increased pride and ownership.

The team has been hard at work making sure we are doing everything possible to best serve our customers.

When it comes to purchasing products, we know you have a choice and we appreciate and take pride in being your supplier of choice. We do not take that for granted. Thank you for your business and for putting your trust in us.

## 2025 is going to be a great year!

Economic predictions are strong and the future is bright. We have lots of new products launching this year that we are excited about and we are excited to share them with you. Some of these are game-changers for the industry such as our innovative approach to Recreational Swim Ponds and Wetland Filtration with our Pit-Viper Diffuser System. (pages 40-43) Rec Ponds just got a lot less time and labor intensive! We're also introducing Sound Shield for aeration, which drastically reduces the loudness of compressors. See Sound Shield in our Lake & Pond Management catalog.

We are here to help you in any way you need – let's work together for your best year yet!  
We wish you all the best for 2025.

Blessings,

*Paul Cole, President and CEO*



*"faith as small as a mustard seed can move mountains"*  
– Matthew 17:20



## IMPORTANT INFORMATION

### EasyPro Authorized Distributor and Dealer Program and Enforced MAP Policy

EasyPro has in place one of the strongest and most enforceable Unilateral Distributor and Dealer Authorization Program in the industry in conjunction with an actively enforceable MAP (Minimum Advertised Price) Policy, which allows us to protect the quality and value of the EasyPro Brand.

Authorized supply chain partners are confidently able to profitably capitalize on selling the added value of their services, product knowledge, and warranty services that unauthorized sellers will not be able to provide.

For more details about this program, email us at [asp@easypro.com](mailto:asp@easypro.com).



## Lake & Pond Management Catalog

EasyPro offers a large selection of Lake & Pond Management products from weed and algae controls to aeration systems to fountains.

We have a separate catalog devoted solely to products and services needed to maintain larger bodies of water and Aquaculture.

**Contact us via phone or website  
to view or request copies  
of our catalogs!**

Cover photo: Recreational Swim Pond designed by Craig Frick and installed by Superior Lawn and Landscape (MN), a customer of Alta Falls (MN)



**800-448-3873**



# Catalog Symbols



**RETAIL READY**  
Our most popular pond items packaged and ready for retail



**MOTOR FREIGHT**  
Certain items ship motor freight only due to size or content



**MADE IN THE USA!**  
We are proud to offer as many USA-made items as possible



**DISCOUNTS**  
Buy it by the case and receive discounts!



**ECO-FRIENDLY**  
Environmentally safe products, good for use with fish & plants



**PRICE DROP**  
Lower prices on select products



**MAP (Minimum Advertised Price) Protection**

This symbol indicates MAP Protected products. Look for the green shield next to the List Price on all affected products. Contact us for the complete 2025 MAP price list.

## Get it NOW!



### Digital Promotion

EasyPro.com • Social Media Sharable "How To" Articles



### Promotional Materials

Catalogs • Guides  
Sell Sheets • Brochures



### Branded Promotions

EasyPro® Branded Materials:  
Banners • Displays

## In Your Resource Portal

We're making it faster and easier than ever for you to access EasyPro dealer resources!

We understand that quick and easy access to business resources is vital. The EasyPro Resource Portal is your new go-to hub for:

- Order forms
- Product images
- Product videos
- Social media drag and drop ads
- "How To" Series articles
- Promotional materials
- Sell sheets
- Brochures
- Handouts
- Project calculators

**Free Sales Tools!**

Visit the EasyPro Portal today!



### Digital Promotion - see more on page 145



Access a library of new and refreshed ready-to-use EasyPro® product posts for your social media accounts! We even help with suggested wording that you can copy/paste right into your own business posts.

Educate your customers about products and pond related issues by sharing the many "How To" Series articles available.



### Promotional Materials - see more on page 146

Access PDF versions of the current EasyPro® catalogs along with data/sell sheets, and guides like the Effective Pond Management Brochure that educate and inspire you and your customers.

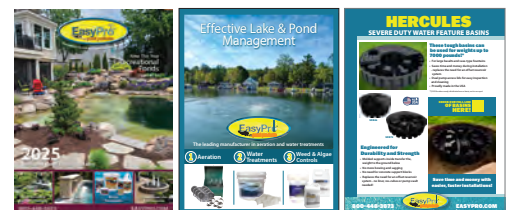



## Rec Ponds!

Get in on the next trend in pond building!

pages 40-43

We've partnered with premier pond builders to develop the best recreational swim pond kits and wetland filter systems and we have the best components to build them.



pages 140-141



## GAST Sound Shield Technology for Super Quiet Aeration

The quietest compressors in the industry! Available on select compressors and aeration systems EXCLUSIVELY from EasyPro.



pages 52-53

## CAST and CAST SOURCE Lighting

EasyPro is proud to announce we are now a Master Distributor of CAST & CAST SOURCE Landscape Lighting!



page 114

## Swim-Rated Pumps

Bring your rec ponds to life with swim-rated pumps! We now have swim-rated pumps from Speck Pumps and EasyPro. External, high-flow pumps, also in variable speed options.

## DuraLiner™ 60 mil EPDM Liner and 10 oz. Underlayment

Now carrying thicker, tougher 60 mil EPDM DuraLiner™ and 10 oz. Underlayment for rec ponds and projects that require a little extra strength.



pages 60-61

**New for 2025**



## Sugar Kettle Fountains

Authentic cast iron sugar kettles patina to a beautiful, natural color with an infinity-like water flow

### Fountain features

- Cast iron sugar kettle (see dimensions below)
- Inside of the kettle is sealed black to provide a nice reflection and to keep the water clear and safe for aquatic life.

### SK39 Complete kit includes

- 39" Sugar Kettle Bowl
- Sugar Kettle Stand
- 30 mil PVC liner
- SDB46 46" Hercules Basin
- EasyPro EPA9500 pump
- Box style water fill valve
- 1/4" plastic mesh
- Plumbing kit & fittings
- Light kits available - see table below.\*\*

Part #	Description	Volume (Gallons)	Kettle Dimensions Diameter x Depth	Stocking Code	Ship Weight	List Price
SK39K	3.25' Diameter Sugar Kettle Fountain complete kit	55	39" x 16"	73317048	515 lbs.*	\$4226.79
SK3LED**	Optional warm white light kit**	-	-	8154063	6 lbs. *	\$204.79
SK4RGB**	Optional color changing light kit**	-	-	3243627	6 lbs.*	\$324.19



Cast Iron Sugar Kettles Only - Contact us to have our team help you build a custom kit for your project!

SK39	3.25' Diameter Sugar Kettle, drilled	55	39" x 16"	21599916	225 lbs.*	\$1999.89
SK48	4' Diameter Sugar Kettle, drilled	65	48" x 16"	41679914	360 lbs.*	\$2099.89
SK60	5' Diameter Sugar Kettle, drilled	130	60" x 20"	82239596	500 lbs.*	\$2799.49
SK84	7' Diameter Sugar Kettle, drilled	395	84" x 30"	63199915	820 lbs.*	\$3999.89

\*Sugar Kettles ship directly from the manufacturer. Kit components ship from EasyPro.

\*\* Kettles are custom drilled for light kits. Light kits must be specified at time of order.





## Infinity Bowl Fountains



**HBO16** - The 16" Infinity Bowl Fountain features two carved spillways which give this bubbling feature the added sight and sound of small waterfalls.

### Basalt features

- 16" Infinity Bowl fountain measures 16" wide x 8" tall\*
- Bowl is core drilled with a 1¼" (32 mm) hole from end to end, the last 1½" is enlarged to 1⅜" (37 mm) to hide light ring (page 16)

### HBO16K Complete kits includes

- 16" Infinity Bowl Fountain
- Plumbing kit
- RBH29 Redi-Basin
- LED8B light
- Tranquil Décor MP425 pump



**HBO24** - The 24" Infinity Bowl Fountain features a calm surface with smoothly flowing water that cascades over the rippled edges of the bowl, creating an enchanting experience.

### Basalt features

- 24" Infinity Bowl fountain measures 24" wide x 12" tall\*
- Bowl is core drilled with a 1¼" (32 mm) hole from end to end, the last 1½" is enlarged to 1⅜" (37 mm) to hide light ring (page 16)

### HBO24K Complete kits includes

- 24" Infinity Bowl Fountain
- Plumbing kit
- FBL40 Sturdi-Basin with support blocks and fine screen mesh
- Tranquil Décor MP575 pump
- LED8B light

Part #	Description	Stocking Code	Approximate Ship Weight	List Price
<b>HBO16K</b>	16" Infinity Bowl Fountain complete kit	8594207	140 lbs.	\$776.99
<b>HBO16</b>	16" Infinity Bowl Fountain only	5356498	110 lbs.	\$459.99
<b>HBO24K</b>	24" Infinity Bowl Fountain complete kit	61104703	364 lbs.	\$1441.99
<b>HBO24</b>	24" Infinity Bowl Fountain only	1720749	264 lbs.	\$929.99



\*Due to the natural characteristics of basalts - the size, weight and color will vary. Rocks shown inside the bowl are not included.

## Ebony Basalt Trio

### Contemporary elegance

### Basalt features

- Sold only in sets of three, with or without kit components
- Each column is core drilled with a 1¼" (32 mm) hole from end to end, the last 1½" is enlarged to 1⅜" (37 mm) to hide light ring (page 16)
- Due to natural characteristics of the basalts - the size, weight and number of sides will vary

### HBC3PSL Complete kit includes

- Three basalts approximately 12", 18" and 24" tall by 6" x 6" wide
- Tranquil Décor MP1000 pump
- FBL48 Sturdi-Basin with support blocks and fine screen mesh
- Splitter and plumbing kit
- LED8B3 light kit



Part #	Description	Stocking Code	Approximate Ship Weight	List Price
<b>HBC3PSL</b>	Ebony Basalt Trio complete kit	6870773	295 lbs.	\$1161.09
<b>HBC3P</b>	Basalts only, 3 piece set	6374995	195 lbs.	\$499.99







**HEIGHTS\***  
6", 12", 18"  
**DIAMETER\***  
8"-11" each\*

**Keyed Spillway**



**HEIGHTS\***  
8", 20", 27"  
**DIAMETER\***  
12"-16" each\*

**Keyed Spillway XL - 1.5x larger footprint!**

## Keyed Spillway Basalt Fountains Two Sizes To Choose From!

Taller two basalts have spillways carved into them. Water flows from one column to the next, and to basin below.

### Basalt features

- Sold only in the full sets of three, with or without kit
- Tallest column is core drilled with a 1¼" (32 mm) hole from end to end, the last 1½" is enlarged to 1⅜" (37 mm) to hide light ring (page 16)
- Due to natural characteristics of the basalts - the size, weight and number of sides will vary.

### Keyed Spillway

#### HBK3KSL Complete kit includes

- Three basalts approximately 6", 12" and 18" tall by 8"-11" diameter
- RBH29 basin
- MP230 pump
- Plumbing kit
- LED8B light

### Keyed Spillway XL

#### HBKL3K Complete kit includes

- Three basalts approximately 8", 20" and 27" tall by 12"-16" diameter
- FBL48 Sturdi-Basin with support blocks
- Tranquil Décor MP1000 pump
- Splitter and plumbing kit
- LED8B light kit



Part #	Description	Stocking Code	Approximate Ship Weight	List Price
HBK3KSL	Keyed Spillway Basalts complete kit	9695822	190 lbs.	\$927.79
HBK3K	Keyed Spillway Basalts - stones only, 3 piece set	3502497	155 lbs.	\$669.99
HBKL3K	Keyed Spillway XL Basalt Fountain Trio complete kit	71336458	562 lbs.	\$1746.99
HBKL3	Keyed spillway XL Basalts - stones only, 3 piece set	9813746	462 lbs.	\$1049.99



## Costola Basalt Fountain

The Costola Basalt Fountain features stunning chiseled contours with a beautifully ribbed inset.

### Basalt features

- 36" tall with 12" to 15" average diameter
- Column is core drilled with a 1¼" (32 mm) hole from end to end, the last 1½" is enlarged to 1⅜" (37 mm) to hide light ring (page 16)
- Due to natural characteristics of basalts - the size, weight, color and number of sides will vary.

### HBR336K Complete kit includes

- Basalt column
- FBL48 Sturdi-Basin with support blocks (2) and fine screen mesh
- Tranquil Décor MP575 pump
- Plumbing kit
- LED8B light kit

Part #	Description	Stocking Code	Approximate Ship Weight	List Price
HBR336K	Costola Basalt Fountain kit	31040958	625 lbs.	\$1361.99
HBR336	36" basalt only	4604493	525 lbs.	\$779.99





## Modern Basalt Fountain Trios

### Two Sizes To Choose From!

Contoured and textured with partially polished tops and one decoratively polished corner on each column

#### Basalt features

- Sold only in sets of three, with or without kit components
- Each column is core drilled with a 1¼" (32 mm) hole from end to end, the last 1½" is enlarged to 1⅜" (37 mm) to hide light ring (page 16)
- Due to natural characteristics of the basalts - the size, weight and number of sides will vary.

#### Modern Basalt Trio

##### HBM3PSL Complete kit includes

- Three basalts approximately 12", 17" and 24" tall by 7"-9" diameter
- FBL48 basin with support block
- MP1000 pump
- Splitter and plumbing kit
- LED8B3 light kit



#### Modern Basalt XL Trio

##### HBML3K Complete kit includes

- Three basalts approximately 12", 18" and 24" tall by 12"-16" diameter\*
- FBL48 Sturdi-Basin with support blocks
- Tranquil Décor MP1000 pump
- Plumbing kit
- LED8B3 light kit



Modern Basalt Fountain Trio



Modern Basalt XL - 3x larger footprint!

Part #	Description	Stocking Code	Approximate Ship Weight	List Price
<b>HBM3PSL</b>	Modern Basalt Fountain Trio complete kit	21016279	305 lbs.	\$1355.09
<b>HBM3P</b>	Modern Basalt Fountain Trio Basalts only, 3 piece set	7524995	240 lbs.	\$699.99
<b>HBML3K</b>	Modern Basalt XL Fountain Trio complete kit	71297702	812 lbs.	\$1696.99
<b>HBML3</b>	Modern Basalt XL Fountain Trio Basalts only, 3 piece set	2774997	712 lbs.	\$999.99



## Bevel Sided Basalt Fountain

16" tall, polished on two sides with smooth polished top

Scan Code for Video

Bevel Sided Basalt Fountain Kit



#### Basalt features

- 14" to 16" average diameter
- Column is core drilled with a 1¼" (32 mm) hole from end to end, the last 1½" is enlarged to 1⅜" (37 mm) to hide light ring (page 16)
- Due to natural characteristics of the basalts - the size, weight and number of sides will vary

#### HPS16K Complete kit includes

- Basalt column
- RBH29 Redi-Basin
- Tranquil Décor MP230 pump
- Plumbing kit
- LED8B light kit

Part #	Description	Stocking Code	Approximate Ship Weight	List Price
<b>HPS16K</b>	Bevel Sided Basalt Fountain complete kit	3496118	205 lbs.	\$661.49
<b>HPS16</b>	16" basalt only	8299992	175 lbs.	\$399.99







## The Original Polished Top Basalt Fountain!

**Best Sellers!**

Few things can match the simple beauty of real basalt columns

### Basalt features

- Sold only in the full sets of three, with or without kit
- All columns are core drilled with a 1¼" (32 mm) hole from end to end, the last 1½" is enlarged to 1⅜" (37 mm) to hide light ring (page 16)
- Due to natural characteristics of the basalts - the size, weight and number of sides will vary.

Scan Code for Video



### Medium Polished Top - HBR3B

- Three basalts approximately 14", 20" and 27" tall by 8"-11" diameter

### Tall Polished Top - HBR3C

- Three basalts approximately 20", 27" and 35" tall by 6"-11" diameter (varies)

### HBR3BSL & HBR3CSL Kits include:

- Three basalt columns - sizes listed on left
- FBL48 Sturdi-Basin with support blocks (2) and fine screen mesh
- MP1000 pump
- Splitter and plumbing kit
- LED8B3 light kit

Part #	Description	Stocking Code	Approximate Ship Weight	List Price
HBR3BSL	Medium Polished Top 3pk basalt complete kit	71190579	390 lbs.	\$1587.49
HBR3B	Medium Polished Top 3pk basalt columns only - 14", 20", 27"	9674991	267 lbs.	\$899.99
HBR3CSL	Tall Polished Top 3pk basalt complete kit	41413778	450 lbs.	\$1885.09
HBR3C	Tall Polished Top 3pk basalt columns only - 20", 27", 35"	6862492	350 lbs.	\$1149.99



# Three sizes!



## Large Polished Top Basalt Fountain Three Piece Set

Ideal for commercial and upscale residential installations

### Basalt features

- Three piece set with polished tops - 10" to 12" average diameter, 32", 38" and 44" tall\*
- Core drilled with a 1¼" (32 mm) hole from end to end, the last 1½" is enlarged to 1⅜" (37 mm) to hide light ring (page 16)
- Due to natural characteristics of the basalts - the size, weight and number of sides will vary.

### HBR3DKSL Basalt Kits include

- Three basalt columns
- FBL58 Sturdi-Basin with support blocks (4) and fine screen mesh
- MP1000 pump
- Splitter and plumbing kit
- LED8B3 light kit



Part #	Description	Stocking Code	Approximate Ship Weight	List Price
HBR3DKSL	Large Polished Top complete kit	32050206	860 lbs.	\$2730.99
HBR3DKN	Large Polished Top 3pk basalt columns only	61312491	700 lbs.	\$1749.99



## Our Best Selling Natural Top Basalt Fountain!

### Set of 3 Natural Top Basalts

#### Basalt features

- Sold only in the full sets of three, with or without kit
- All columns are core drilled with a 1/4" (32 mm) hole from end to end, the last 1/2" is enlarged to 3/8" (37 mm) to hide light ring (page 16)
- Due to natural characteristics of the basalts - the size, weight and number of sides will vary.

#### Medium Natural Top - HBS3B

- Three basalts approximately 14", 20" and 27" tall by 8"-11" diameter

#### Tall Natural Top - HBS3C

- Three basalts approximately 20", 27" and 35" tall by 6"-11" diameter (varies)

#### HBS3BSL & HBS3CSL Kits include:

- Three basalt columns - sizes listed on left
- FBL48 Sturdi-Basin with support blocks (2) and fine screen mesh
- MP1000 pump
- Splitter and plumbing kit
- LED8B3 light kit

Best Sellers!

Scan Code for Video



Part #	Description	Stocking Code	Approximate Ship Weight	List Price
HBS3BSL	Medium Natural Top 3pk basalt complete kit	41134779	390 lbs.	\$1513.09
HBS3B	Medium Natural Top 3pk basalt columns only - 14", 20", 27"	9383242	267 lbs.	\$510.99
HBS3CSL	Tall Natural Top 3pk basalt complete kit	21337043	435 lbs.	\$1782.79
HBS3C	Tall Natural Top 3pk basalt columns only - 20", 27", 35"	3824997	335 lbs.	\$1099.99

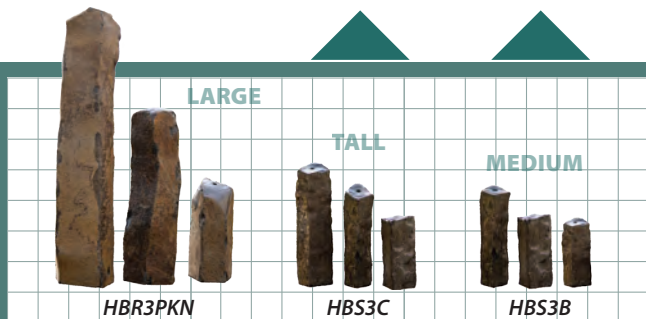

# Three sizes!

## Large Natural Top Basalt Fountain Three Piece Set

Impressive 7' Height!

### Take your bubbling rock installations to a whole new level

#### Basalt features

- Three piece set with natural tops - 14" to 18" average diameter, 3', 5' and 7' tall\*
- 2" inlet hole is core drilled in the side for use with 1/2" pipe, smooth bottom allows for easier installation!
- Due to natural characteristics of the basalts - the size, weight and number of sides will vary.



Install using an Offset Reservoir System. To learn more, scan the QR code with your mobile phone and follow your phone's prompt to our resource page!



Part #	Description	Stocking Code	Approximate Ship Weight	List Price
HBR3PKN	Large Natural Top Basalts	81649993	2200 lbs.	\$2199.99







## Dome Top Basalt Three Piece Fountain Set

Polished, dome-shaped carved top allows the water to cascade down all sides of these beautiful pieces.

### Basalt features

- Each column is core drilled with a 1¼" (32 mm) hole from end to end, the last 1½" is enlarged to 1⅜" (37 mm) to hide light ring (page 16)
- Dome tops spill water from all sides
- Due to natural characteristics of the basalts - the size, weight and number of sides will vary.

### HRD3CSL Complete kit includes

- Three basalts approximately 20", 27" and 35" tall by 7"-11" diameter (varies)
- FBL48 Sturdi-Basin with support blocks and fine screen mesh
- Tranquil Décor MP1000 pump
- Splitter and plumbing kit
- LED8B3 light kit



HRD3C

Part #	Description	Stocking Code	Approximate Ship Weight	List Price
HRD3CSL	Dome top basalts complete kit	41413779	490 lbs.	\$1885.09
HRD3C	3pk dome top basalts - 20", 27", 35"	5862493	405 lbs.	\$1149.99



## Pedestal Fountain

Low-profile accent fountain brings the tranquil sound of water to smaller outdoor living spaces.

### Basalt features

- Pedestal base is approximately 8" tall by 8"-10" diameter
- Fountain top is approximately 22"-26" diameter and 3.25" tall and is core drilled with a 1¼" (32 mm) hole from end to end, the last 1½" is enlarged to 1⅜" (37 mm) to hide light ring (page 16)
- Due to the natural characteristics of basalts - the size, weight, color, and number of sides will vary

### HBLP26K Complete kit includes

- Pedestal Fountain
- FBL40 Sturdi-Basin with support blocks and fine screen mesh
- Tranquil Décor MP575 pump
- PK1L Plumbing kit
- LED8B light

Part #	Description	Stocking Code	Approximate Ship Weight	List Price
HBLP26K	Pedestal Fountain complete kit	3633969	218 lbs.	\$831.99
HBLP26	Pedestal Fountain only	6309997	128 lbs.	\$399.99





## Step Top Basalt Fountain Set

Water skips down the steps creating a fun, unique flow

### Basalt features

- Each column is core drilled with a 1¼" (32 mm) hole from end to end, the last ½" is enlarged to 1⅝" (37 mm) to hide light ring (page 16)
- Decoratively carved top spills water down
- Due to natural characteristics of the basalts - the size, weight and number of sides will vary.

### HST3CSL Complete kit includes

- Three basalts approximately 20", 27" and 35" tall by 8"-10" diameter (varies)
- FBL48 Sturdi-Basin with support blocks
- Tranquil Décor MP1000 pump
- Splitter and plumbing kit
- LED8B3 light kit



Part #	Description	Stocking Code	Approximate Ship Weight	List Price
HST3CSL	Step Top Basalts complete kit	61508302	550 lbs.	\$2011.09
HST3C	3pk Step Top basalts - 20", 27", 35"	2937497	450 lbs.	\$1249.99



## Textured Midnight Basalt Fountain Trio

Unique texture and rich color

### Basalt features

- Also available as three piece set without kit components.
- Each column is core drilled with a 1¼" (32 mm) hole from end to end, the last ½" is enlarged to 1⅝" (37 mm) to hide light ring (page 16)
- Due to natural characteristics of basalts - the size, weight, color and number of sides will vary.

### HBEB3CK Complete kit includes

- Three basalts approximately 24", 30" and 36" tall by 10"-12" diameter
- FBL48 Sturdi-Basin with support blocks and fine screen mesh
- Tranquil Décor MP1000 pump
- Splitter and plumbing kit
- LED8B3 light kit



Part #	Description	Stocking Code	Approximate Ship Weight	List Price
HBEB3CK	Textured Midnight Basalt Fountain Trio complete kit	31654206	1300 lbs.	\$2156.99
HBEB3C	Basalts only, 3 piece set	51131497	1200 lbs.	\$1459.99



## Twisted Basalt Fountain

Turn heads with this 39" tall, helix-shaped basalt!

### Basalt features

- Twisted basalt column is core drilled with a 1¼" (32 mm) hole from end to end, the last ½" is enlarged to 1⅝" (37 mm) to hide light ring (page 16)
- Polished top with chiseled sides
- 10" diameter
- Due to natural characteristics of basalts - the size, weight and color will vary.

### HBT39RK Complete kit includes

- 39" Twisted basalt column
- FBL48 Sturdi-Basin with support blocks and fine screen mesh
- Tranquil Décor MP575 pump
- Plumbing kit
- LED8B light kit



Part #	Description	Stocking Code	Approximate Ship Weight	List Price
HBTR39K	Twisted Basalt Fountain complete kit	41234543	355 lbs.	\$1646.09
HBTR39	39" basalt only	1899992	255 lbs.	\$1199.99







## Levitation Fountain

**A unique, low-profile work of art that appears to float above the splash zone**

### Basalt features

- 24" diameter x 12" tall with a 6" pedestal\*
- Core drilled with a 1¼" (32 mm) hole from end to end, the last 1½" is enlarged to 1⅜" (37 mm) to hide light ring (page 16)
- Unique, low-profile look
- Due to natural characteristics of the basalts - the size, weight and number of sides will vary.

### HBLV2KL Complete kit includes

- Levitation stone fountain
- FBL48 Sturdi-Basin with support blocks and fine screen mesh
- Tranquil DÉcor MP575 pump
- Plumbing kit
- LED8B light kit



*Each fountain arrives completely protected in wooden crate*

Part #	Description	Stocking Code	Approximate Ship Weight	List Price
<b>HBLV2KL</b>	Levitation Fountain complete kit	81512898	717 lbs.	\$2017.29
<b>HBLV2</b>	Levitation Fountain Only	21124997	617 lbs.	\$1499.99



## Triad Fountain

**Left, right and center. The best things come in threes!**

Three independent water flows are ready to take center stage in your next installation.

### Basalt features

- 48" long x 24" wide x 12" tall\*
- Three core drilled holes - each is 1¼" (32 mm) hole from end to end, the last 1½" is enlarged to 1⅜" (37 mm) to hide light ring (page 16)
- Each hole is plumbed separately
- Use PK3LG friction rings (page 16) around tubing to seal hole for maximum effect
- Polished top with natural sides and chiseled ends
- Due to natural characteristics of the basalts - the size, weight and number of sides will vary.

### HTR3FK Complete kit includes

- Basalt stone
- SDB72 72" Hercules Basin
- Tranquil DÉcor MP1000 pump
- Plumbing kit with splitter
- LED8B3 light kit



*For protection, Triad Fountains ship in crates*

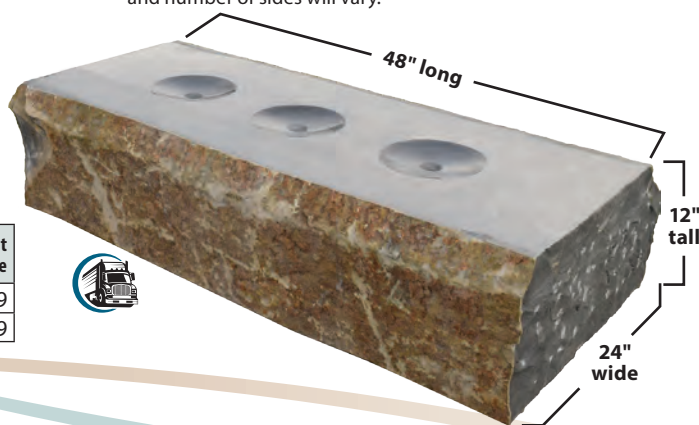

Part #	Description	Stocking Code	Approximate Ship Weight	List Price
<b>HTR3FK</b>	Triad Fountain Kit	42683208	1660 lbs.	\$3574.99
<b>HTR3F</b>	Triad Fountain Only	61949991	1410 lbs.	\$2599.99





## Trilogy Falls Basalt Set

**Four stones.  
Three water flows.  
Too beautiful.  
One awesome 360° display!**

### Basalt features

- Center column is core drilled with three inlets.
- Recommended flow rate: 2500 to 4000 gph total
- 7' to 9' diameter minimum splash zone recommended (varies by actual stone size and flow rate)
- Due to natural characteristics of the basalts - the size, weight and number of sides will vary.

### HBF30K Complete kit includes

- Trilogy Falls 4 Piece Basalt Set - center column is approx. 14" to 22" in diameter by 23" to 32" tall. Three outer "splash" stones measure approx. 18" to 24" in diameter and 10" to 13" tall.
- SDB72 72" Hercules Basin
- TLS4250 Spirit Pump
- Plumbing kit
- WFS50 Fill Valve
- 15' x 10' Liner for extending splash zone



stone placement  
and water flow

Scan Code  
for Video

See the  
Trilogy Falls  
in action on our  
YouTube channel!



Part #	Description	Stocking Code	Approximate Ship Weight	List Price
HBF30K	Trilogy Falls complete kit	43878886	2320 lbs.	\$5063.34
HBF30	Trilogy Falls Basalt 4 piece set - stones only	32062496	2000 lbs.	\$2749.99



## Corona Basalt Fountain

**Casually formal with a polished top and one irregular side.  
Stands a full 35" tall for a great statement piece.**

### Basalt features

- 35" tall with 14" to 16" average diameter
- Column is core drilled with a 1¼" (32 mm) hole from end to end, the last 1½" is enlarged to 1¾" (37 mm) to hide light ring (page 16)
- Due to natural characteristics of basalts - the size, weight, color and number of sides will vary.

### HTP35K Complete kit includes

- Basalt column
- Plumbing kit
- FBL48 Sturdi-Basin with support blocks and fine screen mesh
- LED88 light kit
- Tranquil Décor MP575 pump



Part #	Description	Stocking Code	Approximate Ship Weight	List Price
HTP35K	Corona Basalt Fountain complete kit	91095046	600 lbs.	\$1460.09
HTP35	35" basalt only	8749992	500 lbs.	\$999.99







## Polished Side Basalt Fountain

39" tall, polished side basalt

### Basalt features

- Awesome display — running or not!
- 14" to 16" average diameter
- Each column is core drilled with a 1¼" (32 mm) hole from end to end, the last 1½" is enlarged to 1⅝" (37 mm) to hide light ring (page 16)
- Due to natural characteristics of the basalts - the size, weight and number of sides will vary



### HPS39K Complete kit includes

- Basalt column
- FBL48 Sturdi-Basin with support blocks and fine screen mesh
- Tranquil Décor MP575 pump
- Plumbing kit
- LED8B light kit

Part #	Description	Stocking Code	Approximate Ship Weight	List Price
HPS39K	Polished Side Basalt complete kit	91025297	600 lbs.	\$1367.09
HPS39	39" basalt only	3674991	500 lbs.	\$899.99

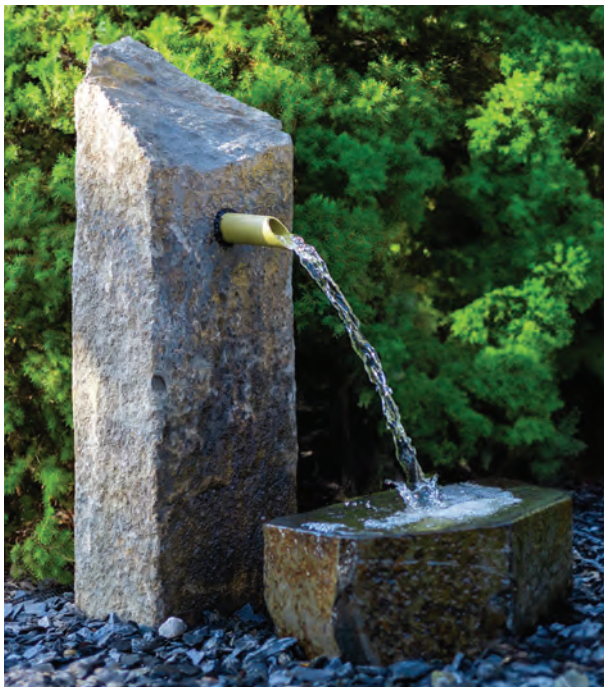

## Bamboo Basalt Fountain Set

Blending the classic tranquility of a bamboo fountain with a stately basalt stone

### Basalt features

- Taller basalt is core drilled with 1¼" (32 mm) hole at the bottom and connects to the side hole for bamboo attachment. Water cascades from the bamboo spout to lower basalt stone, which overflows to basin below.
- Due to natural characteristics of the basalts - the size, weight and number of sides will vary



### HBB39K Complete kit includes

- 39" Pillar basalt approx. 8"-10" diameter
- 8"-10" tall lower stone approx. 12"-15" diameter
- Long-lasting synthetic bamboo spout
- FBL48 Sturdi-Basin with support blocks and fine screen mesh
- Tranquil Décor MP230 pump
- Plumbing kit

Part #	Description	Stocking Code	Approximate Ship Weight	List Price
HBB39K	Bamboo Basalt Fountain complete kit	1983228	420 lbs.	\$1310.99
HBB39	2pc fountain w/ bamboo spout	9674993	320 lbs.	\$899.99







**Solano**  
*Sophisticated*



**Cortez**  
*Adventurous*



**Somerset**  
*Smooth*



**Moreno**  
*Artistic*

**TranquilDécor**  
designer series

Three 6" x 11" stones, approx. 18", 24" and 30" tall\*

Each column is core drilled with a 1¼" (32 mm) hole from end to end, the last 1½" is enlarged to 1⅜" (37 mm) to hide light ring. (page 16)

Each set is available as stones only or as a complete kit.

\*Due to the natural characteristics of the stones, the weight and color will vary



**Phoenix**  
*Sizzling*

**Complete kits include**

- Three 6" by 11" stones, approx. 18", 24" and 30" tall
- FBL48 Sturdi-Basin with support blocks and fine screen mesh
- Tranquil Décor MP1000 pump
- Splitter and plumbing kit
- LED8B3 light kit

Part #	Description	Stocking Code	Ship Weight	List Price
--------	-------------	---------------	-------------	------------

**Solano Fountain Set - four smooth sides**

<b>HDS330KL</b>	Solano complete kit	21213147	577 lbs.	\$1617.59
<b>HDS330</b>	Stones only, 3 piece set	2749994	477 lbs.	\$999.99

**Cortez Fountain Set - three smooth sides, one natural**

<b>HDS325KL</b>	Cortez complete kit	31213145	561 lbs.	\$1617.59
<b>HDS325</b>	Stones only, 3 piece set	3749995	461 lbs.	\$999.99

**Somerset Fountain Set - four smooth sides**

<b>HDS335KL</b>	Somerset complete kit	41213146	577 lbs.	\$1617.59
<b>HDS335</b>	Stones only, 3 piece set	4749996	477 lbs.	\$999.99

**Moreno Fountain Set - four smooth sides**

<b>HDS320KL</b>	Moreno complete kit	51213147	582 lbs.	\$1617.59
<b>HDS320</b>	Stones only, 3 piece set	5749997	482 lbs.	\$999.99

**Phoenix - three smooth sides, one natural**

<b>HDS310KL</b>	Phoenix complete kit	61213148	573 lbs.	\$1617.59
<b>HDS310</b>	Stones only, 3 piece set	6749998	473 lbs.	\$999.99







## Mag Drive Pumps

Perfect submersible pump for fountains and bubbler features

- Compact, energy efficient design
- Oil free, environmentally safe
- Built in adjustable flow control
- 115 volts – 60 Hz
- One year warranty
- MP295, MP425, MP575 have 1/2" female threaded outlet
- MP1000 has 3/4" female threaded outlet

Part #	Maximum gph	Watts	Barb outlet Sizes	Cord Length	Maximum Head	Dimensions (H x W x D)	Case Quantity	Stocking Code	Ship Weight	List Price
MP125	125	5	1/2"	6'	28"	2.0" x 1.6" x 2.4"	6	313495	2 lbs.	\$17.99
MP230	230	13	1/2"	13'	60"	2.6" x 2.0" x 3.0"	6	422496	2 lbs.	\$29.99
MP295	295	17	1/2", 5/8", 3/4"	13'	60"	3.0" x 2.2" x 3.5"	6	541992	3 lbs.	\$55.99
MP425	425	27	1/2", 5/8", 3/4"	13'	98"	3.4" x 2.7" x 4.0"	4	248746	3 lbs.	\$64.99
MP575	575	44	1/2", 5/8", 3/4"	13'	98"	3.8" x 2.9" x 4.4"	4	859994	3 lbs.	\$79.99
MP1000	1000	93	1/2", 3/4", 1"	13'	108"	4.5" x 3.3" x 5.2"	4	489993	4 lbs.	\$119.99



## Statuary Splitter

- 1/2" and 3/4" stepped barb fittings on inlet and outlet
- Individual flow control valve on each line



Part #	Case Quantity	Stocking Code	Ship Weight	List Price
TWS3	12	313497	1 lb.	\$17.99

## Statuary Splitter

Ideal for operating multiple pieces of statuary off one pump

### SS4 Splitter

- Connect end to end to make 8, 12, 16, etc. manifolds
- Handles up to 1200 gph flow
- Can be used with water or air pumps



SS4



SS41238



SS41234

Part #	Size	Stocking Code	Ship Weight	List Price
SS4	3/4" with 1/2" valves	137497	1 lb.	\$49.99

Specialty fittings for SS4 outlet to statuary tubing:

Part #	Size	Stocking Code	Ship Weight	List Price
SS41238	1/2" fpt x 3/8" barb	71602	1 lb.	\$2.29
SS41212	1/2" fpt x 1/2" barb	31678	1 lb.	\$2.39
SS41234	1/2" fpt x 3/4" barb	42937	1 lb.	\$4.19

## LED Statuary Light Set

- Designed for use with most Tranquil Décor fountains and basalts
- Cool white light
- Removable barbed inlet fitting for use with 3/4" tubing
- 1 3/8" diameter
- 12 per case
- 10' power cord between light and transformer



Part #	Description	Stocking Code	Ship Weight	List Price
LED8B	LED Light & 5w Transformer	329994	2 lbs.	\$39.99
LED8B3	3 LED Lights & 5w Transformer	159997	3 lbs.	\$79.99



## Plumbing Kits for Basalts



PK3LG Friction Ring



PK1L



PK3L

- Connect pump to basalt columns
- 1 3/8" O.D. friction ring holds tubing inside basalt and seals hole for best bubbling effect
- PK1L includes 5' of 3/4" tubing and one friction ring
- PK3L includes splitter, 16' of 3/4" tubing and three friction rings

Part #	Description	Stocking Code	Ship Weight	List Price
PK1L	Single	58996	1 lb.	\$11.99
PK3L	Triple	935243	1 lb.	\$46.99
PK3LG	1 3/8" O.D. Friction Ring	82998	—	\$3.99 ea.



## Redi-Basin TranquilDécor™

- Strong HDPE molded tubs
- Use center support (included) under lid for heavy loads up to 300 lbs.
- Deeper for increased water volume
- Stackable for reduced shipping costs



Buy 10 Redi-Basins  
Save 10%  
Contact us  
for details



Fountains and Falls (FL)



Part #	Description	Capacity	Stocking Code	Ship Weight	List Price
RBH29	Rectangle Basin - 29" x 24" x 13½" tall	30 gallons	9149991	21 lbs.*	\$199.99

\*Dimensional shipping rate applies

## Heavy Duty Round Basin ECO-Series®

### Roto-molded for superior strength

- Molded center section has multiple legs for increased load capacity
- Ideal for use with concrete statuary, vases, rocks and fountains
- 19 gallon capacity, 28" diameter x 12" tall
- Two-part basin with bottom tub and molded center section

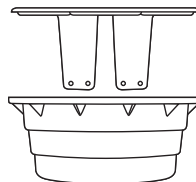

Part #	Description	Stocking Code	Ship Weight	List Price
FB28E	Heavy duty round basin	3172497	21 lbs.*	\$229.99

\*Dimensional shipping rate applies



## Medium Duty Square Basin PRO-SERIES™

### Ideal for small statues, vases or rocks where splash is minimal

- Pump access door for easy removal and service
- Fine mesh screen and supports included
- Mag drive pumps from 120 gph to 600 gph are recommended
- 15 gallon capacity, 26" x 26" x 12" tall
- 150 pound capacity when evenly distributed



Part #	Description	Stocking Code	Ship Weight	List Price
EFB26	Medium duty square basin	6185246	19 lbs.*	\$246.99

\*Dimensional shipping rate applies





# Fountain Basins



SINCE 1970



WeekEnding, Inc. (MI)



Nature's Green Nursery (OH)



## Half Basin



Ideal for use with wall block

- Install on decks, patios, indoors — above grade or buried
- One piece, half circle design fits snug to wall, easy to install
- Includes anti-splash strip to minimize water loss, larger splash mat is available for use with extended lip spillways
- Use WFS37HB auto-fill valve assembly kit (page 20) to maintain water level
- 35 gallon capacity, 1" threaded outlet
- 48"L x 24"W x 15 1/2"H



FWB48 Basin  
with optional  
FWB48SM  
Splash Mat

Part #	Description	Stocking Code	Ship Weight	List Price
<b>FWB48</b>	48" half basin	7243743	28 lbs.*	\$324.99
<b>FWB48SM</b>	14" x 39" extended surface splash mat	123242	3 lbs.	\$30.99



\*Dimensional shipping rate applies

## Sturdi-Basin

ECO-Series



Best Sellers!

Versatile basins — ideal for use with a variety of fountain pieces

- Clear span grating — no legs for easy pump installation and removal
- Designed for concrete blocks to sit under grating which greatly increases load capacity!
- Fine mesh screen and support blocks included
- 100 pound load rating with grating only, 500+ pounds when used with blocks
- 40", 48" and 58" sizes available



**NEW!** Includes fine screen mesh,  
Part #FSB18



**NEW!** Includes concrete blocks  
for increased load capacity

Part #	Description	Capacity	Height	Stocking Code	Ship Weight	List Price
<b>FBL40</b>	40" basin w/bench grating	30 gallons	11 3/4"	3284996	24 lbs.	\$379.99
<b>FBL48</b>	48" basin w/bench grating	46 gallons	11 3/4"	6337491	35 lbs.	\$449.99
<b>FBL58</b>	58" basin w/bench grating	68 gallons	11 3/4"	4539992	62 lbs.	\$719.99



## Heavy Duty Fountain Basins

### Dura-Basin

Roto-molded for superior strength

- Engineered to be self supporting, so no cement blocks or other props are needed to support the grating
- Thickest, strongest grating of any similar product.
- Measuring 50" x 50" x 14" deep, basin is ideal for large individual features or can hold multiple smaller pieces for an impressive display. Use pumps up to 3200 gph.
- Fine mesh screen included
- 200 pound capacity with grating only, 750+ pounds when supports are filled with concrete



Underwater Warehouse (PA)



Part #	Capacity	Stocking Code	Ship Weight	List Price
EFB50	80 gallons	9449996	65 lbs.	\$599.99

### Sturdi-Basin EX

Ideal for use with statuary, vases, rocks and fountains

- Support grates have multiple legs for increased load capacity
- Four access doors allow for multiple pumps, auto-fill, underwater lights or can be used as plant pockets
- Measures 58" x 58" x 11¾" deep
- Molded columns transfer weight to the ground below. Can also be filled with concrete to create pillars for heavy statuary
- Also available with bench grating. See FBL58 on page 18.
- 500 pound capacity with support grates only, 1,000+ pounds when supports are filled with concrete



Part #	Capacity	Stocking Code	Ship Weight	List Price
FB58E	65 gallons	1558743	64 lbs.	\$744.99

### Hercules Basin

These "severe duty" basins have been used with weights up to 7,000 lbs!\*

For large basalts and large vase type fountains. Multiple molded legs transfer the weight into the ground below, eliminating bowing or sagging.

- Perfect for larger water features - replaces the need for an offset reservoir system, saving you time and money during installation
- Engineered for durability and strength
- Dual pump access lids for easy inspection and cleaning



#### SDB46

46" diameter x 17" deep  
125 gallon - 7,000 lb.\* capacity



#### SDB72

72" diameter x 17" deep  
250 gallon - 7,000 lb.\* capacity



\* 7,000 lb. capacity when evenly distributed across basin, not in one spot

Part #	Description	Capacity	Stocking Code	Ship Weight	List Price
SDB46*	Hercules Basin - 46"	125 gallons	9799996	130 lbs.	\$999.99
SDB72*	Hercules Basin - 72"	250 gallons	91383996	190 lbs.	\$1729.99





# Vianti Falls Spillway Kits



SINCE 1970

## Vianti Falls™ KITS

Everything you need to build a simple yet beautiful waterfall in virtually any block wall!

### Simply elegant!

Vianti Falls kits combine all the elements you need to add the beauty of water to any indoor or outdoor block wall.

- Molded basin
- Stainless steel spillway
- EasyPro® mag drive pump
- PVC flex pipe and fittings
- Auto fill valves sold separately. Use WFS37 for 11" kits (see page 49) or use WFS37HB for 23" & 35" kits (see below).
- Dimensional shipping rate applies



### Spillway kits with 2" lip

Part #	Description	Pump Included	Basin Included	Stocking Code	Ship Weight	List Price
HB11K	11½" Vianti Falls kit - no lights	EP850	RBH29	2508526	28 lbs.	\$681.09
HB11KB	11½" Vianti Falls kit - blue lights	EP850	RBH29	6579763	30 lbs.	\$776.09
HB11KW	11½" Vianti Falls kit - white lights	EP850	RBH29	4579767	30 lbs.	\$776.09
HB23K	23½" Vianti Falls kit - no lights	EP1350	FWB48	3666797	54 lbs.	\$892.19
HB23KB	23½" Vianti Falls kit - blue lights	EP1350	FWB48	8802618	55 lbs.	\$1074.59
HB23KW	23½" Vianti Falls kit - white lights	EP1350	FWB48	9802617	55 lbs.	\$1074.59
HB35K	35½" Vianti Falls kit - no lights	EP2200	FWB48	6804869	62 lbs.	\$1078.39
HB35KB	35½" Vianti Falls kit - blue lights	EP2200	FWB48	3990107	63 lbs.	\$1325.39
HB35KW	35½" Vianti Falls kit - white lights	EP2200	FWB48	8990102	63 lbs.	\$1325.39
WFS37HB	Auto fill valve assembly kit for Vianti Falls	—	—	757748	1 lb.	\$76.99

### Spillway kits with extended 6" lip spillway and larger splash mat

Part #	Description	Pump Included	Basin Included	Stocking Code	Ship Weight	List Price
HB11KEX	11½" Vianti Falls kit w/extended lip spillway - no lights	EP850	RBH29	6549283	30 lbs.	\$735.49
HB11KBEX	11½" Vianti Falls kit w/extended lip spillway - blue lights	EP850	RBH29	7620524	31 lbs.	\$830.49
HB11KWEX	11½" Vianti Falls kit w/extended lip spillway - white lights	EP850	RBH29	8620522	31 lbs.	\$830.49
HB23KEX	23½" Vianti Falls kit w/extended lip spillway - no lights	EP1350	FWB48	1759599	57 lbs.	\$1015.89
HB23KBEX	23½" Vianti Falls kit w/extended lip spillway - blue lights	EP1350	FWB48	7895413	58 lbs.	\$1198.29
HB23KWEX	23½" Vianti Falls kit w/extended lip spillway - white lights	EP1350	FWB48	2895413	58 lbs.	\$1198.29
HB35KEX	35½" Vianti Falls kit w/extended lip spillway - no lights	EP2200	FWB48	1902181	64 lbs.	\$1208.19
HB35KBEX	35½" Vianti Falls kit w/extended lip spillway - blue lights	EP2200	FWB48	21087422	65 lbs.	\$1455.19
HB35KWEX	35½" Vianti Falls kit w/extended lip spillway - white lights	EP2200	FWB48	41087428	65 lbs.	\$1455.19



SINCE 1970

# Vianti Falls Spillways

## Viantifalls™ SPILLWAYS

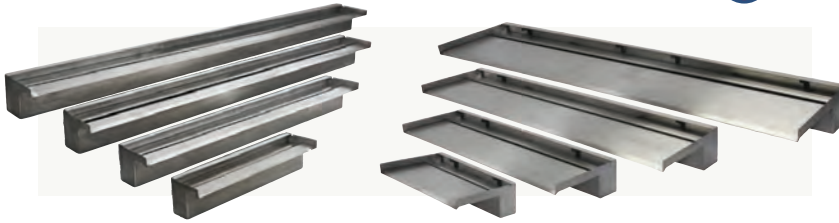

Available with standard 2" lip (above left) or 6" extended lip (above right)!



Supplier (ST)

### Stainless steel for maximum strength

- Available in a variety of sizes and styles
- Rated for ten gallons per minute flow per foot of width
- LED light strips can be used on spillways — see pages 55 and 56
- Internal baffle calms incoming water — creating even, smooth flow over lip
- Ideal for formal features, signs and other unique features
- 3 year warranty

### Clog-Free Design

Part #	Spillway Width	Spillway Lip Style	Quantity 1" Inlets	Recommended Flow (gph)	Stocking Code	Ship Weight	List Price
SSS11	11½"	2" lip	1	600	4239025	4 lbs.	\$318.69
SSS23	23½"	2" lip	1	1200	6247497	8 lbs.	\$329.99
SSS35	35½"	2" lip	2	1800	8320249	12 lbs.*	\$426.99
SSS47	47½"	2" lip	2	2400	2377993	17 lbs.*	\$503.99
SSS59	59½"	2" lip	3	3000	1577499	20 lbs.*	\$769.99
SSS71	71½"	2" lip	3	3600	9620242	26 lbs.*	\$826.99
SSS611	11½"	6" lip	1	600	4281922	5 lbs.	\$375.89
SSS623	23½"	6" lip	1	1200	6320927	10 lbs.	\$427.89
SSS635	35½"	6" lip	2	1800	5399447	14 lbs.*	\$532.59
SSS647	47½"	6" lip	2	2400	8456673	23 lbs.*	\$608.89
SSS659	59½"	6" lip	3	3000	2625499	28 lbs.*	\$833.99
SSS671	71½"	6" lip	3	3600	2899997	36 lbs.*	\$1199.99

\*Dimensional shipping rate applies



Great Lakes Landscape (MI)



Lan-De-Con (MN)

Fittings are not included -  
Use the fittings below for tubing connections

Part #	Description	Stocking Code	Ship Weight	List Price
MA10	1" PVC male adapter (mpt x slip)	71623	1 lb.	\$2.49
STL10T	1" PVC street elbow (mpt x slip)	23577	1 lb.	\$5.49
TA100E	1" barbed 90° elbow (mpt x barb)	92653	1 lb.	\$3.79



## LIGHTING

### Underwater LED light strips



Add optional lighting for a stunning night time display! Choose from warm white, blue or step it up even more with Cabrio Underwater LED Light Strips. All are available in 11", 23" and 35" lengths. Use in pairs for longer spillways. See pages 55 and 56 for light strip options.



# Vianti Falls Spillways



## Viantifalls™ Extended 15" Lip Spillways

Ideal for windy locations — extends waterfall out away from wall



SSS1547  
SSS1559 &  
SSS1571

Part #	Spillway Width	Spillway Lip Style	Quantity 1" Outlets	Recommended Flow (gph)	Stocking Code	Ship Weight	List Price
SSS1535	35½"	15" lip	2	1800-2700	2614995	22 lbs.	\$819.99
SSS1547	47½"	15" lip	2	2400-3600	9802494	33 lbs.	\$1069.99
SSS1559	59½"	15" lip	3	3000-4500	7926242	40 lbs.	\$1234.99
SSS1571	71½"	15" lip	3	3600-5400	31222497	55 lbs.	\$1629.99

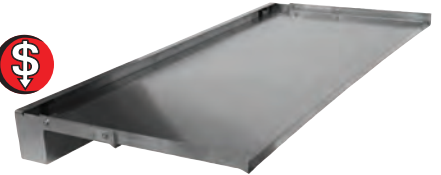

## Viantifalls™ Wall Scuppers

A classic, stand-alone water feature or use as a tasteful accent in any formal water feature

Scan Code for Video



### Stainless Steel



High Quality - American Made!

- 304 stainless steel
- Electro-polished for extra protection in pools and other chlorinated systems.
- Bonding lugs added



Round #SWS2RN

- 2" dia. by 8" long
- 3½" dia. round trim plate



Square #SWS2SN

- 2½" x 2½" x 11" long
- No trim plate



Channel #SWS3RN

- 3" w x 2" h x 11" long
- No trim plate



Diamond #SWS2DN

- 2" dia. by 8" long
- 4½" x 6½" diamond trim plate

Part #	Description	Recommended Flow Rate	Inlet	Stocking Code	Ship Weight	List Price
SWS2RN	2" round wall scupper w/round wall plate	5-10 gpm	1" fpt	6167997	3 lbs.	\$209.99
SWS2SN	2½" x 2½" square scupper	5-10 gpm	1" fpt	5175994	4 lbs.	\$219.99
SWS3RN	3" wide x 2" high channel/rectangle scupper	5-10 gpm	1" fpt	3175992	4 lbs.	\$219.99
SWS2DN	2" round wall scupper w/diamond plate	5-10 gpm	1" fpt	9152797	3 lbs.	\$190.99

### Antique Brass

Classically Beautiful

- Solid brass fixtures with antique finish for a classic look\*
- Ground screw included on BWS2F and BWS2RN units
- Perfect for adding a formal look to pools and water features

\* Antique Brass Scuppers are crafted and antiqued by hand. Finish color may vary.



Antique Round

#BWS2F

- 2" dia. by 5½" long
- 5¾" dia. round trim plate



Round

#BWS2RN

- 2" dia. by 5¾" long
- 3½" dia. round trim plate



Diamond

#BWS2D

- 2" dia. by 5¾" long
- 5½" x 5½" diamond trim plate

Part #	Description	Recommended Flow Rate	Inlet	Stocking Code	Ship Weight	List Price
BWS2F	Brass 2" antique round	10-20 gpm	1½" fpt	3112497	4 lbs.	\$149.99
BWS2RN	Brass 2" round w/round wall plate	5-15 gpm	1½" fpt	982494	3 lbs.	\$109.99
BWS2D	Brass 2" round w/diamond wall plate	5-15 gpm	1½" fpt	582495	3 lbs.	\$109.99



## ECO-Series® Waterfall Diffusers

### The Original & Still The Best!

Faster to install than any other spillway on the market

- Ideal for use at beginning of streams and in block walls, pools and formal fountains
- Extra strong vertical rib design creates a nearly indestructible diffuser - stack block directly on top!
- 3½" low profile makes them easy to conceal, and the consistent 14" depth ensures that all sizes will work together
- Install right-side-up for a smooth sheet of water or upside-down for a more natural flow.
- Units have dual 2" inlet



Outside Inc (MI)

### We offer the largest selection of waterfall spillways in the industry!

ECO-Series® Spillways are available in 12" to 48" widths and the patented Pro-Series Modular System (page 25) can be made in endless sizes and shapes.

Waterfall spillways are the perfect choice for Just-A-Falls (pond-less) systems, signs, swimming pool features and other installations where a cascade of water is desired and filtration is not needed.



UWD46

UWD23



UWD32

UWD16

Scan Code for Video

ECO-Series Waterfall Diffuser Installation



### One Diffuser - Two Water Flow Looks!

ECO-Series® Diffusers may be installed right-side-up (see UWD16 and UWD32 above) for a smooth sheet of water or upside down (see UWD46 and UWD23 above) for a more natural looking water flow.



Made to last and faster to install than any other spillway on the market!

Part #	Description	Recommended Flow (gph)	Stocking Code	Ship Weight	List Price
UWD16	16" diffuser	1000-4000	889994	5 lbs.	\$119.99
UWD23	23" diffuser	1500-6000	8115496	8 lbs.	\$153.99
UWD32	Dual 16" diffusers	2000-8000	6179987	10 lbs.	\$239.99
UWD46	Dual 23" diffusers	3000-12000	5230982	16 lbs.	\$307.99



Extra strong, load-bearing, vertical rib design allows block and rock to be stacked on top.



Out-of-the-box installation. Simply plumb into either side and it's ready to go.



Since block can be stacked on top, no additional support is needed.



## ECO-Series® One Piece Waterfall Spillways

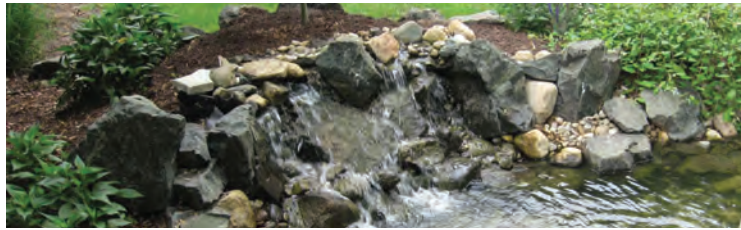

### Easy Installation!

**Ideal for Creating Just-A-Falls Water Features**

- Roto-molded for excellent strength
- Dual inlets — 2" spinwelds (pre-installed) allow for easy plumbing into either end, a plug for unused end is included, CF12E has one 1½" inlet pre-installed on back of unit
- 4" diffuser tube lays across the bottom of the spillway between inlet fittings
- Water enters from either end (or both ends) and spreads out evenly across width of spillway
  - Gravel can be used to fill the inside of the spillway creating a natural, even looking waterfall

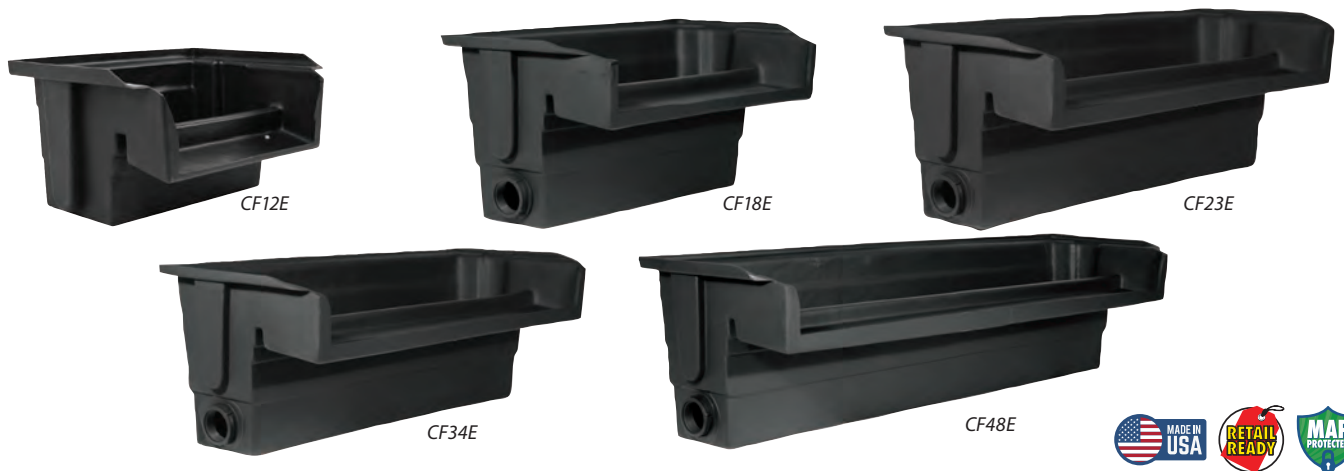

Part #	Description	Dimensions (LxWxH)	Inlet Size/Location	Recommended flow (gph)		Stocking Code	Ship Weight	List Price
				Single Inlet	Both Inlets			
CF12E*	12" spillway	16½" x 13" x 9"	1½" back	max: 3000gph	—	763746	5 lbs.*	\$84.99
CF18E*	18" spillway	22" x 14½" x 13½"	2" both ends	up to 3400	max 4500	9127498	11 lbs.*	\$169.99
CF23E*	23" spillway	27¾" x 14½" x 13½"	2" both ends	up to 4500	max: 6000	8142491	12 lbs.*	\$189.99
CF34E*	34" spillway	37¼" x 14½" x 13½"	2" both ends	up to 6400	max: 8500	3198742	22 lbs.*	\$264.99
CF48E*	48" spillway	52½" x 14½" x 13½"	2" both ends	up to 6400	max: 12,000	6254995	27 lbs.*	\$339.99
CF18FS*	18" Faux Stone Lip	—	—	—	—	528791	2 lbs.*	\$38.39
CF23FS*	23" Faux Stone Lip	—	—	—	—	337492	3 lbs.*	\$49.99

\*Dimensional shipping rate applies

### Easy Install with our patented "Spliner Lock" System!

No silicone.  
No bolts.  
No tools.

### Faux Stone Lip

For a more natural look

- Available for CF18E & CF23E

Inlet spinweld comes installed, simply connect incoming supply line

Connecting the liner takes only seconds using the patented Spliner Lock System!

Fill spillway with gravel/ small cobble stone, plug in pump and enjoy!

**Constructed to Last!**

**Patented Modular, Expandable Design**

Pro-Series waterfall spillways have a plastic grating just below the water level that prevents the walls from bowing when buried and also allows you to stack 3" - 4" of rock on top to hide the spillway. Straight and curved spillway sections can be connected in any configuration.

## PRO-SERIES™

### Modular Waterfall Spillways

#### Original "Straight" Spillways

Expandable and constructed to last

Straight spillways, 18" tall in widths of 18", 34" and 50" come assembled and ready to be installed. The straight, inward and outward pieces are interchangeable and can be used in any combination. Make waterfalls as narrow or as wide as you wish!

- Dual bulkheads (included) allow incoming water from either or both ends. A plug is included for whichever end is not used.
- Waterfall spillways are designed to sit inside the liner eliminating any concerns of leaking. The liner simply goes under the spillway and up the back side. The bulkhead fitting secures liner to tub where the pipe attaches to the spillway.



Part #	Description	Inlet/Bulkhead	Spillway Width	Stocking Code	Ship Weight	List Price
<b>EWS18</b>	18" straight - assembled	2" inlet	18"	6214498	19 lbs.*	\$285.99
<b>EWS34</b>	34" straight - assembled	2" inlet	34"	9329991	30 lbs.*	\$439.99
<b>EWS50</b>	50" straight - assembled	3" inlet	50"	5517495	54 lbs.*	\$689.99



\*Dimensional shipping rate applies



Smalls Landscaping (IN)



EWE16 (4), EWLR3 (1), EWI16 (2), EWO16 (2)



#### Expandable Spillways

The only expandable waterfall spillway on the market!

- With straight, inward or outward curving sections you can custom design the shape of your feature
- Waterfalls up to 34' wide have been built using this system
- Pieces are interchangeable with straight pieces above, use in any combination
- Everything bolts together for easy assembly

Part #	Description	Inlet/Bulkhead	Spillway Width	Stocking Code	Ship Weight	List Price
<b>EWE16</b>	16" extension straight (not pictured)	—	16"	9123746	12 lbs.*	\$164.99
<b>EWI16</b>	Inward curving extension	—	16"	2134997	15 lbs.*	\$179.99
<b>EWO16</b>	Outward curving extension	—	24"	7134998	15 lbs.*	\$179.99
<b>EWLR2</b>	Left and right set unassembled (for 2" pipe)	2"	18"	2209994	18 lbs.*	\$279.99
<b>EWLR3</b>	Left and right set unassembled (for 3" pipe)	3"	18"	4314996	18 lbs.*	\$419.99



\*Dimensional shipping rate applies



# Pump Vaults



## Retail Pump Vaults

- Roto-molded for excellent strength
- Ideal for use with mag drive pumps
- Retail ready



JAFM can be used with JAFME extension sold below



JAFV can be used with JAFVE extension sold below

JAFV can be used with multiple mag drive pumps



Part #	Dimensions (LxWxH)	Maximum Flow	Stocking Code	Ship Weight	List Price
JAFM	13" dia. x 14½" h	3000 gph	282492	7 lbs.*	\$109.99
JAFV	20" dia. x 20" h	10000 gph	3149997	14 lbs.*	\$199.99

\*Dimensional shipping rate applies



## Contractor Pump Vaults **PRO-SERIES™**

The strongest pump vaults in the industry! Built heavy duty to withstand the weight of rock.

- The slots cut into the sides of the vaults allow water to flow freely into the pump chamber.
- Intake tubes are available for JAFM and JAFV to increase flow capacity.



JAFVE Extension

JAFME Extension

### Pump Vault Extensions

- Flange around bottom slides right over the top edge of the main vault
- Multiple extensions can be used if needed



JAFV

JAFM

JAFM Vault with Intake Tube



Part #	Description	Dimensions (LxWxH)	Maximum Flow	Stocking Code	Ship Weight	List Price
JAFM	Small pump vault	16" x 16" x 22"	7500 gph	8172498	17 lbs.*	\$229.99
JAFME	Small vault extension	13" diameter x 12" tall	—	678742	5 lbs.*	\$104.99
JAFM30	Intake tube for JAFM	4" diameter x 30" long	additional 2500 gph	437492	3 lbs.*	\$49.99
JAFV	Large pump vault	24" x 24" x 32"	18,000 gph	4299996	54 lbs.*	\$399.99
JAFVE	Large vault extension	20" diameter x 18½" tall	—	6119994	9 lbs.*	\$159.99
JAFV30	Intake tube for JAFV	8" diameter x 30" long	additional 5000 gph	297497	6 lbs.*	\$129.99

\*Dimensional shipping rate applies



## Intake Bay Vaults

- Designed for use in intake bays - vaults are the same height as Res-Cubes™ and EasyBog™ Cubes
- Roto-molded for excellent strength
- For compatible check valves, see CVA30IB and CVA40IB on page 42



Part #	Description	Dimensions (LxWxH)	Maximum Flow	Stocking Code	Ship Weight	List Price
JAFIB3	Intake Bay Vault - 3" plumbing	24" x 24" x 17.5"	18,000 gph	4299995	22 lbs.	\$399.99
JAFIB4	Intake Bay Vault - 4" plumbing	24" x 24" x 17.5"	18,000 gph	5299997	22 lbs.	\$399.99



## Res-Cubes

### High-Strength Reservoir Cubes

Smaller reservoirs, reduced rock tonnage, increased water capacity and shorter installation time

- Reduce rock tonnage
- Reservoir can be made smaller because of the increased water percentage due to less rock being used
- Increase reservoir water capacity from 40% with rock to 90%+ with Res-Cubes
- Installation time is reduced considerably - smaller reservoir hole means less digging, less liner and less labor
- Use in high weight-bearing features
- Ideal for use in wetland filtration, Just-A-Falls and pondless features using large boulders
- Ships unassembled to save space, quick and easy assembly on site
- Can be used under patios, pathways, sidewalks, etc.
- Great for retention and recycling of rain water
- HSC22 equals 2.4 cubic feet of space
- HSC44 equals 4.4 cubic feet of space

**Sold in pairs only!**

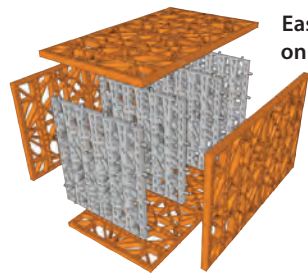

Easy assembly on site

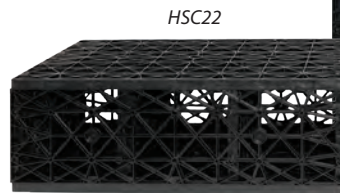

HSC22

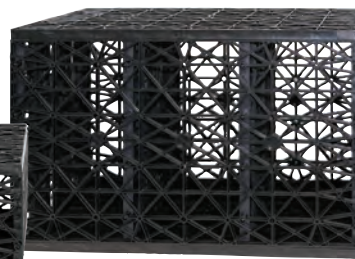

HSC44

### INSTALL



**Buy more, Save more!**  
Contact us for details



**IN-USE**

Porous Pave, Inc (MI)

**NEW HSCCLIP**  
Secure Res-Cubes Together



**NEW PN125**  
Res-Cube Covering Mesh



Part #	Description	Dimensions (LxWxH)	Gallons Each	Pallet Quantity	Stocking Code	Ship Weight	List Price
HSC22	Res-Cube, high strength, half	27" x 16" x 9½"	17	60	930442	23 lbs.*	\$41.99** each
HSC44	Res-Cube, high strength	27" x 16" x 17½"	31½	60	946398	30 lbs.*	\$63.99** each
PN125	<b>NEW</b> Res-Cube Covering Mesh with 1/8" holes - 48" x 50' roll				4158152	12 lbs.	\$197.69
PN125F	<b>NEW</b> Res-Cube Covering Mesh with 1/8" holes - 48" wide and cut to length				43726	—	\$4.65/foot
HSCCLIP	<b>NEW</b> Res-Cube Clips (attach adjacent cubes) - each				7512	1 lb.	\$0.70*** each

\*Dimensional shipping rate applies. \*\*Priced individually but sold in pairs only. Ship weight is for pair \*\*\* Case price break when 30 or more are purchased



## EasyBog™ Cube and EasyBog™ Filtration Kits

### Effective, Natural Pond Filtration

We've taken our popular HSC44 Res-Cube and filled it with Bio-Balls to create a highly effective filtration module! Check them out along with complete EasyBog™ Filtration kits on page 37.



## Larger Pond? Combine EasyBog™ Cubes with our new Pit Viper™ Wetland Diffuser System for a superior Wetland Filtration System!

### For large pond filtration, the Pit Viper™ delivers!

EasyPro's new Wetland Diffuser Systems give you the best in bio-filtration with the bonus of being easier, faster and less expensive to install than traditional systems. Check them out on page 43.





On the next two pages you will find a variety of complete Just-A-Falls kits. Each kit comes with everything you need to build beautiful streams and waterfalls. If one of these kits does not fit your needs, we can customize a kit for you! Simply send us your layout and we will provide you a quote for the materials needed to complete your project.



American Patio Creations

## Mini Just-A-Falls Kit

This mini kit is perfect for those wanting the sound of water but are short on space!

**Kit Includes:**

- **DURALINER**. 45 mil EPDM rubber liner
- Liner underlayment
- 12" waterfall spillway
- EasyPro® pump vault
- High strength Res-Cubes
- Flexible PVC pipe and PVC glue
- 1800 gph direct drive pump and pump outlet assembly



JAF9E

Part #	Stream Length	Liner Size	Reservoir Size L x W x H	Vault	Flex Pipe	Res-Cubes Included	Stocking Code	Ship Weight	List Price
JAF9E	3' stream	7' x 10'	3' x 3' x 18"	JAFT	1 1/4" x 7'	2	9490103	69 lbs.*	\$659.39
JAF10E	7' stream	7' x 15'	3' x 4' x 18"	JAFT	1 1/4" x 12'	4	2602795	79 lbs.*	\$813.39

\*Dimensional shipping rate applies



## PRO-SERIES™ Just-A-Falls Kits

Choose from Just-A-Falls Kits without Res-Cubes or with the Res-Cubes figured in

**Kits Include:**

- **DURALINER**. 45 mil EPDM rubber liner
- Underlayment
- Waterfall spillway
- EasyPro® pump vault
- Submersible pump
- Check valve assembly
- Flexible PVC pipe
- WIK installation kit



HTA Companies (MI)

### Just-A-Falls Kits without High Strength Res-Cubes

Part #	Stream Length	Liner Size	Reservoir Size L x W x H	Vault	Flex Pipe	Pump Included	Spillway Width	Stocking Code	Ship Weight	List Price
JAF1	7' stream	10' x 20'	5' x 5' x 2'	JAFM	2" x 25'	TH150	18"	71161563	127, 20 lbs.*	\$1555.09
JAF2	11' stream	10' x 25'	5' x 6' x 2'	JAFM	2" x 25'	TH400	34"	71466745	140, 32 lbs.*	\$1963.59
JAF3	18' stream	15' x 40'	8' x 10' x 3'	JAFV	3" x 33'	TM9500	50"	92704316	430 lbs.	\$3624.79
JAF4	30' stream	20' x 50'	10' x 12' x 3'	JAFV	3" x 50'	TM13500	82"	83719392	665 lbs.	\$5041.59

\*Dimensional shipping rate applies



### Just-A-Falls Kits with High Strength Res-Cubes Included

Same as the kits above, but with the Res-Cubes figured in!

- Smaller reservoir
- Longer stream
- More water storage

Part #	Description	Approx. Stream Length	HSC22 Res Cubes	HSC44 Res Cubes	Reservoir Size L x W x H	Stocking Code	Ship Weight	List Price
JAF1HSC	Small Just-A-Falls Kit	7'	-	4	4' x 4' x 2'	61320172	237 lbs.	\$1774.89
JAF2HSC	Medium Just-A-Falls Kit	11'	-	6	5' x 5' x 2'	31710189	292 lbs.	\$2300.59
JAF3HSC	Large Just-A-Falls Kit	22'	10	10	6' x 7' x 3'	43403165	725 lbs.	\$4590.89
JAF4HSC	Extra Large Just-A-Falls Kit	34'	16	16	8' x 9' x 3'	54849707	1119 lbs.	\$6602.59



Contact us for free quote assistance on custom Just-A-Falls projects!

## PRO-SERIES™ Just-A-Falls Kits

### Complete Kits!

#### Build Beautiful Waterfalls & Streams

**Kits Include:**

- DuraLiner™ 45 mil EPDM rubber liner
- Pump discharge assembly
- Underlayment
- UWD23 waterfall spillway (28' kit has two)
- EasyPro® pump vault
- Flexible PVC pipe
- Submersible pump
- High strength Res-Cubes
- Installation kit with glue, foam and fittings



8' Stream • #JAF8W  
4' x 4' x 2' Reservoir



16' Stream • #JAF16W  
5' x 5' x 2' Reservoir



24' Stream • #JAF24W  
6' x 6' x 2' Reservoir



28' Stream • #JAF28W  
6' x 6' x 2½' Reservoir

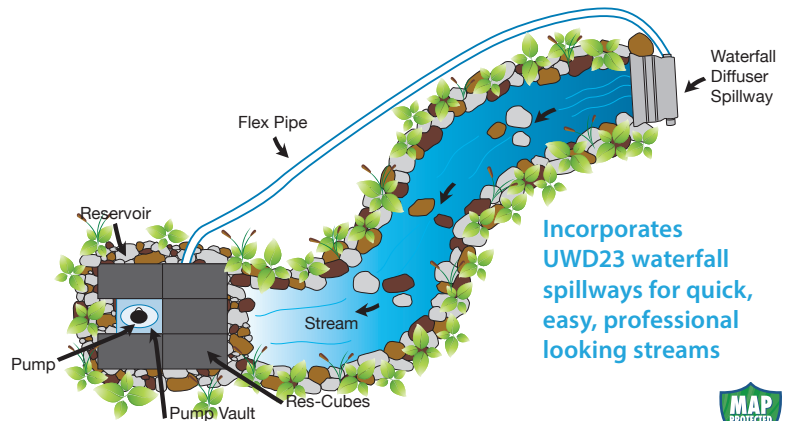

Incorporates UWD23 waterfall spillways for quick, easy, professional looking streams

### Just-A-Falls Kits with Waterfall Diffusers

Part #	Stream Liner Size	Reservoir Liner Size	Vault	Flex Pipe	Pump Included	Res-Cubes Included	Stocking Code	Ship Weight	List Price
JAF8W	7' x 10'	10' x 10'	JAFM	1¼" x 25'	EP2200	3	4902112	106, 43 lbs.*	\$1215.59
JAF16W	7' x 20'	10' x 12'	JAFM	2" x 25'	TH250	5	21299903	102, 97 lbs.*	\$1749.69
JAF24W	8' x 30'	12' x 15'	JAFM	2" x 50'	TH400	7	31675424	338 lbs.	\$2256.79
JAF28W	10' x 33'	15' x 15'	JAFM	2" x 50'	TH750	7†	82338189	473 lbs.	\$3166.49

\*Dimensional shipping rate applies

†JAF28W also includes seven HSC22 half cubes



JAF24W & JAF28W  
Motor Freight Only



Landscape Professionals (OH)



Diether's Watergardens (CT)



Zema's Nursery (NY)





## ECO-Series® Pond Skimmers

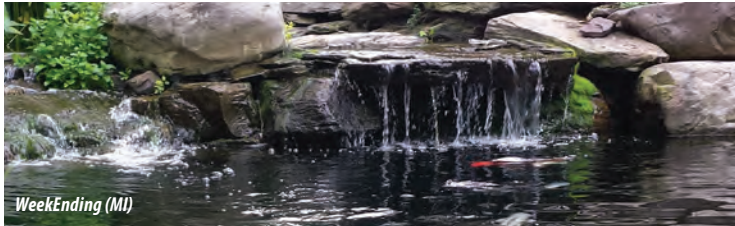

### Patented Design - No Leaks!

The industry's first "in-pond" skimmer

- The ECO-Series Skimmer's patented design lets you install the skimmer **INSIDE** the liner. No cutting the liner, no silicone and **NO LEAKS!**
- Strong-ribbed design holds shape and allows dirt to hold skimmer in place when backfilled
- Ideal for retail sales
- Each skimmer comes complete with molded debris basket, filter pad and lid.
- Debris basket is easy to remove and clean

### Prelude PS4E

Ideal for use with mag drive pumps sold separately on page 100



- Maximum flow 1800 gph (30 gpm)
- Ideal for mag drive pumps
- 18"l x 15"w x 13"h
- 5" water inlet

### Melody PS6E



- Maximum flow 4800 gph (80 gpm)
- 21"l x 22"w x 21"h
- 7" water inlet

### Ovation PS10E



- Maximum flow 8100 gph (135 gpm)
- 21"l x 22"w x 27"h
- 9" water inlet
- Optional molded color lid available (#PS10ML, pg. 34)

Patented design installs inside the liner, eliminating the chance of leaks



Part #	Description	Stocking Code	Ship Weight	List Price
PS4E	Prelude	3119991	12 lbs.	\$159.99
PS6E	Melody	2224996	30 lbs.*	\$299.99
PS10E	Ovation	7262494	35 lbs.*	\$349.99

\*Dimensional shipping rate applies

See page 34 for replacement parts

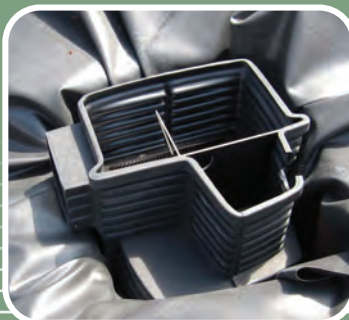

Optional molded color lid available for PS10E (see page 34)



Molded debris basket included with all Eco-Series Skimmers

## 6 reasons to choose Axiom



All black tubs that skim pond water are not the same.

- 1 Fast and secure liner attachment** Faceplate is secured to the unit first BEFORE the liner hole is cut out. No additional realignment of liner and faceplate necessary.
- 2 Integrated UV option** available for the 5000 gallon Axiom Skimmer (PSA5000) for copper-free algae control.
- 3 Extended inlet flange** allows skimmer to be placed farther from the pond edge for a more natural look.
- 4 Adjustable overflow** Sealed tub allows the overflow to be adjusted easily.
- 5 All-in-One option** Skimmer/Filter Combo (PSA3600D) provides filtration without a waterfall filter box. Add EasyPro's Ultimate Tube Media for biological filtration for ponds up to 4000 gallons.
- 6 Compatible with submersible or external pumps** Larger pump chambers can hold one or two submersible pumps.



# Axiom™

## Premium Pond Skimmers

- Front to back design - with the pump sitting behind the debris net instead of along side it
- Adjustable overflow allows finished pond level to be adjusted
- One piece aluminum framed debris net makes cleaning quick and easy
- Includes black silicone

Scan Code for Video

Axiom Premium Pond Skimmers



### PSA5000



- 29"l x 19"w x 21"h
- 6" water inlet
- Dual 2" factory-installed spinweld fittings (bulkheads) allow for one or two pump installations.
- Compatible with PS1 molded faux rock lid (page 34) and PS1UV UV Clarifier (page 33)

### PSA7000



- 29"l x 19"w x 21"h
- 8" water inlet
- Dual 2" factory-installed spinweld fittings (bulkheads) allow for one or two pump installations.
- Compatible with PS1 molded faux rock lid (page 34)

### PSA9000



- 33"l x 19"w x 23"h
- 8" water inlet
- Two 2" and one 3" factory-installed spinweld fittings (bulkheads) allowing for two smaller or one larger pump
- Compatible with SETS2 extension tube (page 33)

### PSA11000



- 33"l x 19"w x 23"h
- 10" water inlet
- Two 2" and one 3" factory-installed spinweld fittings (bulkheads) allowing for two smaller or one larger pump

Part #	Description	Stocking Code	Ship Weight	List Price
PSA5000	5000 gph Axiom skimmer	9359992	35 lbs.*	\$479.99
PSA7000	7000 gph Axiom skimmer	1359993	35 lbs.*	\$479.99
PSA9000	9000 gph Axiom skimmer	4446997	44 lbs.*	\$595.99
PSA11000*	11000 gph Axiom skimmer	8446996	44 lbs.*	\$595.99

\*Dimensional shipping rate applies

See page 34 for replacement parts

• Includes debris net and filter brushes for mechanical filtration

• Includes Ultimate Tube Media in bag (UTM - page 95) biological media for biological filtration



## Axiom™ Pond Skimmer/Filter Combo

### Mechanical and biological filtration all in one for ponds up to 4000 gallons

Includes debris net and filter brushes for mechanical filtration and UTM1 biological media for compete filtration.

Part #	Stocking Code	Ship Weight	List Price
PSA3600D	3479992	56 lbs.*	\$639.99



- 33"l x 19"w x 23"h
- 8" water inlet
- Maximum flow rate: 60 gpm (3600 gph)
- Use with SETS2 extension tube on page 33 (optional)

\*Dimensional shipping rate applies

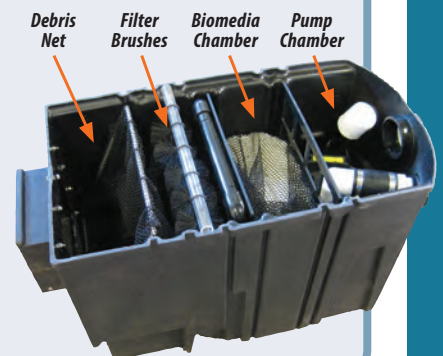



## PRO-SERIES™ Pond Skimmers

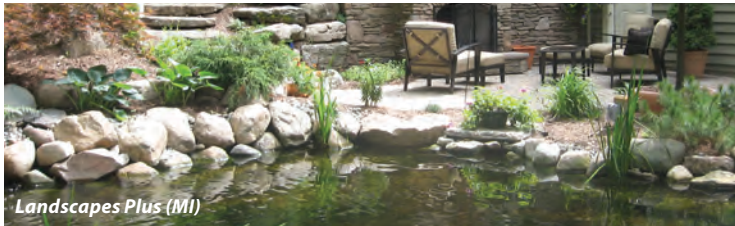

### Innovative Design!

Choose between a vertical filter mat or brushes

- Two chamber design eliminates cutting filter pads to fit around the pump and plumbing
- Pumps can be inspected or removed without removing mesh net or filter pad
- Skimmers have a flange above the opening where water enters from the pond into the skimmer, allowing you to not only stack rocks along side but also above the skimmer opening
- Internal filters help prevent pump from plugging and easily cleaned
- Black silicone included
- See page 34 for replacement parts

### Mini Skimmer PSMFB

Skims ponds up to 250 square feet

- Skims ponds up to 250 square feet
- Available in vertical style pad or filter brushes
- Works with small extension tube (part #SETS) - see page 33



### Small Skimmer PS1FB

Our best selling skimmer!

- Skims ponds up to 600 square feet
- Available with filter pad or filter brushes
- Works with small extension tube (part #SETS) - see page 33
- PS1FB also can be fitted with a UV (part #PS1UV) - see page 33



### Large Skimmer PS2FB

One of the largest skimmers available

- Skims ponds over 600 square feet
- Available with filter pad or filter brushes
- Works with large extension tube (part #SETL) - see page 33



Part #	Description	Size (LxWxH)	Weir Inlet	Max. Flow	Stocking Code	Ship Weight	List Price
PSMFB	Mini w/filter brushes	20" x 15" x 19"	6"	3000 gph	6284998	23 lbs.*	\$379.99
PSM	Mini w/filter pad	20" x 15" x 19"	6"	3000 gph	4299992	23 lbs.*	\$399.99
PS1FB	Small w/filter brushes	28" x 18" x 20"	8"	6000 gph	3427499	44 lbs.*	\$569.99
PS1V	Small w/filter pad	28" x 18" x 20"	8"	6000 gph	7449998	44 lbs.*	\$599.99
PS2FB	Large w/filter brushes	42" x 20" x 30"	16"	18000 gph	1682494	75 lbs.	\$909.99
PS2V	Large w/vertical filter pad	42" x 20" x 30"	16"	18000 gph	3704991	75 lbs.	\$939.99

\*Dimensional shipping rate applies



Use with extension tubes on next page for concealment and unique applications

See page 34 for replacement parts



### Pro Tip

Make your pond look more authentic by moving the skimmer box away from the pond! Skimmer Extension Tubes sold on page 33

The Pro-Series™ line contains products specifically engineered for professional installations. You'll see and feel the quality of the materials and workmanship. Try them and see!

## External Pump Skimmer

EasyPro® is pleased to offer this innovative skimmer designed for use with external pumps

- Factory installed bulkhead fittings
- Pre-plumbed for easy bottom drain connection, includes plug
- Design ensures all water goes through debris net
- Uses same debris net, lid and extension tube as PSMFB
- Multiple skimmers can be plumbed to one pump, ideal for odd shaped ponds where one skimmer is not enough
- 8" weir inlet
- Black silicone included
- Maximum flow 4500 gph
- Measures 20" x 15" x 19"

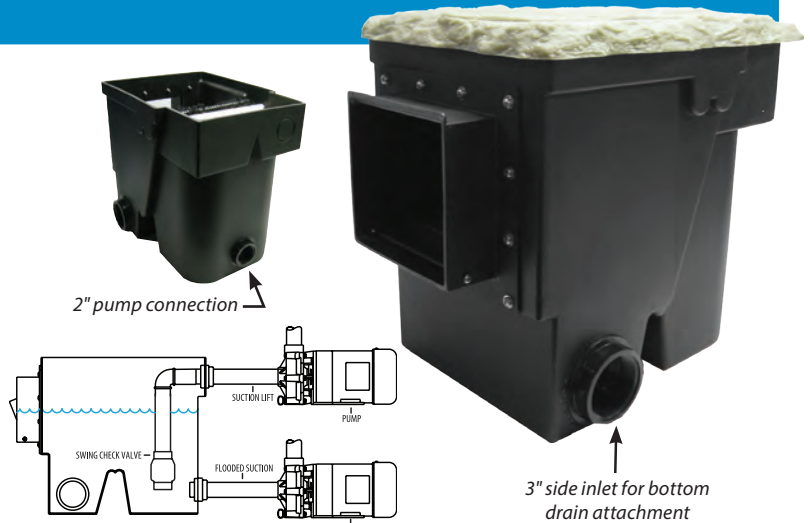

Ideal for use with external pumps on pages 110 - 113

Part #	Stocking Code	Ship Weight	List Price
PSMEX	4254993	22 lbs.*	\$339.99

\*Dimensional shipping rate applies

## Skimmer Extension Tube

Makes your pond look more authentic by moving the skimmer box away from the pond

- Patented 24" long extension tube allows skimmer to be set back from the pond edge
- Allows for planting between the pond and skimmer making it easier to hide
- Can be bolted together to create longer extensions if needed
- Price includes extension tube and bolts for installation
- Ideal for use in concrete walls



Part #	Description	Stocking Code	Ship Weight	List Price
SETS	Fits PSM, PSMEX, PS1 skimmers	482496	9 lbs.*	\$109.99
SETS2	Fits PSA3600D/5000/7000/9000 skimmers	282496	9 lbs.*	\$109.99
SETL	Fits PS2 skimmers	7104993	12 lbs.*	\$139.99



\*Dimensional shipping rate applies

## UV Option for PS1FB & PSA5000 Skimmers

- PS1FB and PSA5000 skimmers can be outfitted with a UV Clarifier
- 36 watt bulb is enclosed inside of a divider that slips in the place of the PVC divider
- Must be used with filter brush racks, not the filter pad style skimmers
- Will drop the maximum gpm flow from 100 to approximately 60 gpm to provide adequate exposure time
- Replacement UV bulbs and sleeves are available



Part #	Description	Stocking Code	Ship Weight	List Price
PS1UV	36 watt UV upgrade for PS1FB & PSA5000	3344994	8 lbs.	\$459.99
EP36B	36 watt replacement bulb for PS1UV	547992	2 lbs.	\$63.99
EP36S	36 watt replacement sleeve for PS1UV	963741	2 lbs.	\$84.99
PS1UVT	Replacement transformer/ballast	8112493	3 lbs.	\$149.99





# Skimmer Replacement Parts



SINCE 1970

## Skimmer Replacement Parts

Part #	Description	Fits Skimmer	Dimensions	Stocking Code	Ship Weight	List Price
<b>ECO-Series</b>						
PS3B	Tempo basket		10¾" x 6½" x 3¾"	415529	2 lbs.	\$20.69
PS4B	Prelude basket	PS4E Prelude	10¾" x 6½" x 3¾"	715528	2 lbs.	\$20.69
PS4M	Prelude mat with grommets	PS4E Prelude	10" x 6¼"	58992	2 lbs.	\$11.99
PS4P	Prelude partition	PS4E Prelude	10¾" x 11¾"H	715742	2 lbs.	\$20.99
PS4L	Prelude lid	PS4E Prelude	14" x 13½"	428873	3 lbs.	\$38.49
PS610B	Melody basket	PS6E Melody	16" x 8¾" x 10"	824143	3 lbs.	\$32.19
PS6M	Melody mat with grommets	PS6E Melody	15¼" x 11"	410491	2 lbs.	\$13.99
PS6P	Melody partition	PS6E Melody	19¾" x 19¾"H	333748	3 lbs.	\$44.99
PS6L	Melody lid	PS6E Melody	22½" x 20½"	530673	4 lbs.	\$40.89
PS610B	Ovation basket	PS10E Ovation	16" x 8¾" x 10"	824143	3 lbs.	\$32.19
PS10M	Ovation mat with grommets	PS10E Ovation	15½" x 15½"	911847	2 lbs.	\$15.79
PS10P	Ovation partition	PS10E Ovation	16¼" x 23¼"H	833743	4 lbs.	\$44.99
PS10L	Ovation lid (black)	PS10E Ovation	20" x 19½" x 1"	232772	4 lbs.	\$43.69
PS10ML	Ovation molded lid (tan)	PS10E Ovation	25" x 23" x 2½"	155275	9 lbs.	\$73.69
<b>Pro-Series</b>						
PMLN	Debris net for Mini Skimmer	PSM/PSMFB	13" x 13"	343197	2 lbs.	\$53.99
PSMM*	Matala pad for Mini Skimmer	PSM/PSMFB	12" x 16"	310647	1 lb.	\$14.19
PSMLID	Lid for Mini Skimmer	PSM/PSMFB	21½" x 16½"	343491	5 lbs.	\$57.99
PSMDV	Divider - Mini Skimmer	PSM	12¾" x 18"H	348378	1 lb.	\$64.49
PSMR*	Filter brush rack - Mini Skimmer	PSMFB	14¼" x 18"H	237497	2 lbs.	\$49.99
PSF6A	6" faceplate & weir	PSM/PSMFB	-	849491	2 lbs.	\$65.99
P1LN	Debris net for Small Skimmer	PS1V/PS1FB	20"L x 11¼"H	847991	2 lbs.	\$59.99
PS1VM*	Matala pad for Small Skimmer	PS1V	14" x 17"	312226	2 lbs.	\$16.29
PS1LID	Lid for Small Skimmer	PS1V/PS1V	32" x 21¾"	389996	14 lbs.	\$119.99
PS1VDV	Divider - Small Skimmer	PS1V	16" x 18¾"H	357748	3 lbs.	\$76.99
PS1R*	Filter brush rack - Small Skimmer	PS1FB	16½" x 18"H	747243	5 lbs.	\$62.99
PSF8A	8" faceplate & weir	PS1V/PS1FB/PSMEX	-	255879	2 lbs.	\$74.49
P2LN	Debris net for Large Skimmer	PS2V/PS2FB	24½"L x 20"H	671991	4 lbs.	\$89.99
PS2VM*	Matala pad for Large Skimmer	PS2V	16" x 26"	325942	4 lbs.	\$34.59
PS2LID	Lid for Large Skimmer	PS2V/PS2FB	47" x 24"	8127492	20 lbs.	\$169.99
PS2VDV	Divider - Large Skimmer	PS2V	16½" x 28¼"H	370492	6 lbs.	\$93.99
PS2R*	Filter brush rack - Large Skimmer	PS2FB	19" x 26"H	474245	8 lbs.	\$98.99
PSF16	16" faceplate & weir	PS2V/PS2FB	-	276343	4 lbs.	\$101.79
PSF8A	8" faceplate & weir	PSMEX	-	255879	2 lbs.	\$74.49
PSAR	Filter brush rack - Axiom	Axiom PSA skimmers	16½" x 18"H	146056	5 lbs.	\$61.40
PSAFM	Filter pad assembly - Axiom	Axiom PSA skimmers	19¼" x 15¼" x 2"	652491	3 lbs.	\$69.99
PSA57N	Debris net - Axiom	PSA5000, PSA7000	14" x 16"	747192	2 lbs.	\$58.99
PSA911N	Debris net - Axiom	PSA3600D, PSA9000, PSA11000	16" x 16"	553594	3 lbs.	\$66.99
PSF6B	6" faceplate & weir - Axiom	PSA5000	-	748891	2 lbs.	\$65.19
PSF8B	8" faceplate & weir - Axiom	PSA3600D, PSA7000, PSA9000	-	456392	2 lbs.	\$75.19
PSF10	10" faceplate & weir - Axiom	PSA11000	-	963893	3 lbs.	\$85.19

\*Assembled in the USA



## Nylon Media Bags

- Used in all of our Eco-Series and Pro-Series filters, these tough nylon media bags will last for many years and can hold all types of large media
- MB21 and MB22 are ¼" mesh and have drawstring with push button release
- Use two MB21 in AS, three in AM and six in AL filters

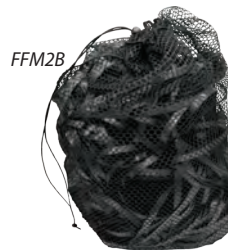

Part #	Description	Dimensions	Stocking Code	Ship Weight	List Price
MB21	Media bag, ¼" mesh (used in AS, AM, AL AquaFalls)	21" x 30"	814996	1 lb.	\$19.99
MB22	Media bag, ¼" mesh (use one in AT mini AquaFalls)	22" x 26"	315742	1 lb.*	\$20.99
FFM2B	MB21 media bag filled with 2 cu. ft. Filter Floss†	21" x 30"	237978	4 lbs.*	\$49.69
BBM2B	MB21 media bag filled with 2 cu. ft. Bio-Blox†	21" x 30"	446491	6 lbs.*	\$61.99

\*Dimensional shipping rate applies †See pages 94-96 for more information on these and other media

## ECO-Series® Waterfall Filters for natural, biological filtration



### Prelude Filter for ponds up to 1000 gallons

- Includes filter box with "Spliner Lock" System, one filter pad, one bag of Bio-Blox media (one cubic foot) and one 1¼" PVC male adapter
- 20"l x 17"w x 14"h
- Optional lid on page 38: WF10L



### Sonata Filter for ponds up to 1800 gallons

- Includes filter box with "Spliner Lock" system, two filter pads, two bags of Bio-Blox media (two cubic feet) and one 1½" PVC male adapter
- 22"l x 25"w x 21"h
- Optional lid on page 38: WF18L



### Melody Filter for ponds up to 3000 gallons

- Includes filter box with "Spliner Lock" system, two filter pads, two large bags of Bio-Blox media (four cubic feet) and one 2" PVC male adapter
- 24"l x 25"w x 24"h
- Optional lid on page 38: WF29L



### Symphony Filter for ponds up to 6000 gallons

- Includes filter box with "Spliner Lock" system, two filter pads, six large bags of Bio-Blox media (twelve cubic feet), one 2" PVC plug and one 2" PVC male adapter
- 37"l x 29"w x 34"h
- Optional lid not available

## Patented, Tool-Free System!

Helps keep ponds clean and clear while supplying an ideal base for waterfalls and streams. Pond water flows up through filter pads and filter media with high surface area allowing suspended debris to be trapped and beneficial bacteria to provide natural biological filtration.

- An excellent choice for the "do-it yourselfer" with professional grade quality
- Easy, user friendly installation - No tools, no worries
- Patented tool-free liner attachment system for the easiest installation of any similar filter on the market
  - Biological filter media included
  - Inlet "spin-weld" fittings are pre-installed
  - Extended lip to eliminate leaks

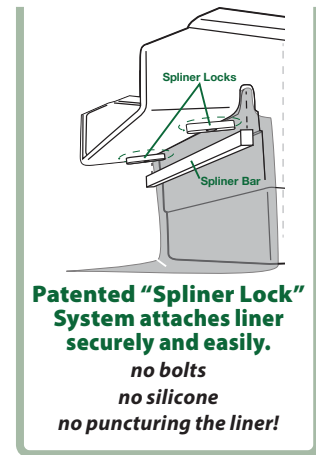

WF60E

Part #	Description	For Ponds Up to (Gallons)	Size	Waterfall Opening	Pre-Installed Water Inlet	Maximum Flow	Stocking Code	Ship Weight	List Price
WF10E	Prelude Filter	1000	20" x 17" x 14"	13"	1¼"	30 gpm/1800 gph	3112491	18 lbs.*	\$149.99
WF18E	Sonata Filter	1800	22" x 25" x 21"	18"	1½"	50 gpm/3000 gph	8239998	28 lbs.*	\$319.99
WF29E	Melody Filter	3000	24" x 25" x 24"	17"	2"	70 gpm/4200 gph	6344995	45 lbs.*	\$459.99
WF60E	Symphony Filter	6000	37" x 29" x 34"	34"	2" (dual)	150 gpm/9000 gph	3599991	73 lbs.*	\$799.99

\*Dimensional shipping rate applies



## Tempo Submersible Pond Filter

### Provides mechanical and biological filtration

- Pump sits under filter pads preventing plugging
- Comes complete with dual media — white inner roll provides biological surface area while black surface media traps debris
- Ideal prefilter for small mag drive pumps



Part #	Description	Size	Tubing Size	Max. Flow	Stocking Code	Ship Weight	List Price
WF6E	Tempo Filter for ponds up to 600 gallons	12½" x 10" tall	¾" or 1"	850 gph	540491	3 lbs.	\$53.99
WF6TP	Replacement top pad	12" dia. x 1" thick	–	–	38627	1 lbs.	\$11.49
WF6BP	Replacement bottom pad	12" dia. coil x 3½" tall	–	–	67879	2 lbs.	\$10.49



## AquaFalls Waterfall Filters

Easy to install. Simply bolt lip to filter!

### Featured Benefits

- AquaFalls Filters are buried into the ground making them easy to hide.
- Can be ordered with Matala filter pads, the best quality filter pads on the market. When ordered with the filter, one green and two blue pads are included - AT includes one each.

See Matala pads on page 96.



# PRO-SERIES™

## AquaFalls Filters

Keep ponds clean and clear while supplying an ideal base for waterfalls and streams. Pond water flows up through filter pads and filter media with high surface area allowing suspended debris to be trapped and beneficial bacteria to provide natural biological filtration.

### Mini AquaFalls

#### AT

- One 1½" inlet fitting in back of filter, tub size 18"l x 24"w x 18"h
- Includes tub with built-in lip, termination bar, stainless steel hardware, two filter pads with support stand, one mesh media bag (MB22), 1½" bulkhead fitting, 1½" PVC male adapter and black silicone



### Small AquaFalls

#### AS

- Two bulkhead fittings allow incoming water from either side — use plug (included) on unused side or install ball valve to use as drain. Tub size 26"l x 26"w x 26"h
- Includes tub, faux rock lip, stainless steel hardware, three filter pads with support stand, two mesh media bags, two - 2" bulkhead fittings, 2" PVC male adapter, 2" x 1½" PVC reducing male adapter, 2" PVC plug and black silicone



### Medium AquaFalls

#### AM

- Two bulkhead fittings allow incoming water from either side — use plug (included) on unused side or install ball valve to use as drain. Tub size 35"l x 36"w x 28"h
- Includes tub, faux rock lip, stainless steel hardware, three filter pads with support stand, three mesh media bags, two - 2" bulkhead fittings, 2" PVC male adapter, 2" PVC plug and black silicone



### Large AquaFalls

#### AL

- Two bulkhead fittings allow incoming water from either side — use plug (included) on unused side or install ball valve to use as drain. Tub size 36"l x 65"w x 36"h
- Includes tub, faux rock lip, stainless steel hardware, three filter pads with support stand, six mesh media bags, two - 3" bulkhead fittings, 3" PVC male adapter, 3" PVC plug and black silicone



Part #	Description	For Ponds Up to (Gallons)	Size (H x W x D)	Waterfall Opening	Bulkhead/ Inlet Fitting	Maximum Flow	Stocking Code	Ship Weight	List Price
AT2	Mini w/Matala pads	1200	18" x 24" x 18"	14"	1½" (1)	40 gpm	8247499	25 lbs.*	\$329.99
AT	Mini Filter	1200	18" x 24" x 18"	14"	1½" (1)	40 gpm	7247496	23 lbs.*	\$329.99
AS2	Small w/Matala pads	2500	26" x 26" x 26"	18"	2" (2)	70 gpm	5427493	35 lbs.*	\$569.99
AS	Small Filter	2500	26" x 26" x 26"	18"	2" (2)	70 gpm	2427494	33 lbs.*	\$569.99
AM2	Medium w/Matala pads	6000	35" x 36" x 28"	26"	2" (2)	120 gpm	4562492	46 lbs.	\$749.99
AM	Medium filter	6000	35" x 36" x 28"	26"	2" (2)	120 gpm	7562497	43 lbs.	\$749.99
AL2	Large w/Matala pads	15000	36" x 65" x 36"	50"	3" (2)	250 gpm	81102491	75 lbs.	\$1469.99
AL	Large Filter	15000	36" x 65" x 36"	50"	3" (2)	250 gpm	21102494	73 lbs	\$1469.99

\*Dimensional shipping rate applies



AM & AL

## AquaFalls with Termination Strips

AquaFalls are available with termination strips instead of lip for those who prefer to use real stone



Part #	Description	Stocking Code	Ship Weight	List Price
AS2T	Small w/Matala pads & termination strip	6382499	34 lbs.*	\$509.99
AST	Small filter w/ termination strip	9382496	32 lbs.*	\$509.99
AM2T	Medium w/Matala pads & termination strip	7509998	45 lbs.	\$679.99
AMT	Medium filter w/ termination strip	6509991	42 lbs.	\$679.99
AL2T	Large w/Matala pads & termination strip	31027492	73 lbs.	\$1369.99
ALT	Large filter w/ termination strip	21027498	71 lbs.	\$1369.99

\*Dimensional shipping rate applies



## PRO-SERIES™ Rock/Plant Grates for AquaFalls Filters



Extra strong grate available for the small, medium and large AquaFalls

- Makes it very easy to cover the falls box with rocks and plants
- The small filter grate is an egg crate shaped material while the medium and large grates are an engineered structural plastic material

Part #	Description	Stocking Code	Ship Weight	List Price
ASGR	Small rock grate	455496	4 lbs.	\$73.99
AMGR	Medium rock grate	3119994	12 lbs.	\$159.99
ALGR	Large rock grate	2209998	28 lbs.*	\$279.99

\*Dimensional shipping rate applies



## ECO-Series® Waterfall Filter Replacement Parts



Part #	Description	Dimensions	Stocking Code	Ship Weight	List Price
WF10L	Prelude filter lid	20½" x 17½"	638843	3 lbs.	\$51.79
WF18L	Sonata filter lid	24¾" x 22½"	749048	5 lbs.	\$65.39
WF29L	Melody filter lid	25½" x 24½"	458192	7 lbs.	\$77.59
WF10P	Prelude filter pad, each	12" x 16"	311994	1 lb.	\$15.99
WF18P	Sonata filter pad, each	18" x 14¼"	213492	1 lb.	\$17.99
WF29P	Melody filter pad, each	23½" x 20½"	327748	1 lb.	\$36.99
WF60P	Symphony filter pad, each	25" x 35"	735996	2 lbs.	\$47.99

## PRO-SERIES™ AquaFalls Replacement Parts

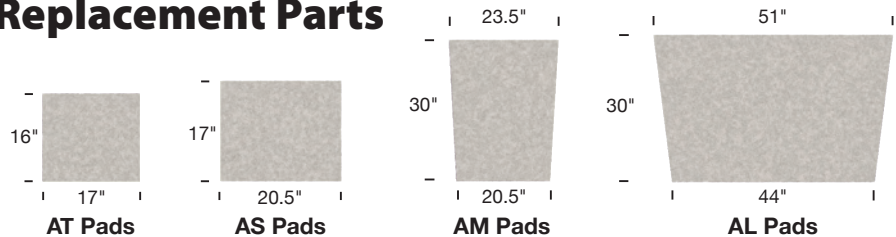

Part #	Description	Stocking Code	Ship Weight	List Price
--------	-------------	---------------	-------------	------------

### AT - Mini AquaFalls

ATM	Replacement filter pad	614996	2 lbs.	\$19.99
ATGN	Green Matala replacement pad	712672	2 lbs.	\$16.89
ATBE	Blue Matala replacement pad	312894	2 lbs.	\$17.19
ATGY	Gray Matala replacement pad	416193	2 lbs.	\$21.59
ATSTA	Replacement stand inside filter	239831	3 lbs.	\$49.79
ATBW	Replacement bolts & washer pack	86749	1 lb.	\$8.99
ATTS	Replacement termination strip	719429	1 lb.	\$25.89

### AS - Small AquaFalls

ASM	Replacement filter pad	817248	2 lbs.	\$22.99
ASGN	Green Matala replacement pad	613942	2 lbs.	\$18.59
ASBE	Blue Matala replacement pad	514325	2 lbs.	\$19.09
ASGY	Gray Matala replacement pad	615448	2 lbs.	\$20.59
ASSTA	Replacement stand inside filter	271998	3 lbs.	\$89.99
ASBW	Replacement bolts & washer pack	29744	1 lb.	\$12.99
ASLIP	Replacement waterfall lip	762993	4 lbs.	\$83.99
ASTS	Replacement termination strip	323779	2 lbs.	\$31.69

Part #	Description	Stocking Code	Ship Weight	List Price
--------	-------------	---------------	-------------	------------

### AM - Medium AquaFalls

AMM	Replacement filter pad	328496	4 lbs.	\$37.99
AMGN	Green Matala replacement pad	926776	4 lbs.	\$35.69
AMBE	Blue Matala replacement pad	827528	4 lbs.	\$36.69
AMGY	Gray Matala replacement pad	129778	4 lbs.	\$39.69
AMSTA	Replacement stand inside filter	279993	5 lbs.	\$99.99
AMBW	Replacement bolts & washer pack	414996	1 lb.	\$19.99
AMLIP	Replacement waterfall lip	878749	4 lbs.	\$104.99
AMTS	Replacement termination strip	928643	2 lbs.	\$38.19

### AL - Large AquaFalls

ALM	Replacement filter pad	348743	5 lbs.	\$64.99
ALGN	Green Matala replacement pad	749643	5 lbs.	\$66.19
ALBE	Blue Matala replacement pad	650324	5 lbs.	\$67.09
ALGY	Gray Matala replacement pad	856179	5 lbs.	\$74.89
ALSTA	Replacement stand inside filter	191032	7 lbs.	\$113.79
ALBW	Replacement bolts & washer pack	223991	2 lbs.	\$31.99
ALLIP	Replacement waterfall lip	8104993	6 lbs.	\$139.99
ALTS	Replacement termination strip	633747	3 lbs.	\$44.99

\*Dimensional shipping rate applies





## Black Waterfall Foam



Use to fill in cracks between rocks to prevent water from being "lost" over the waterfall

- Improves water flow visually and black color hides foam in the shadows of the rocks
- Minimal expanding foam - better density, better control and less waste
- Cans have a patented trigger system and a 'stow straw' which allows multiple uses for up to two weeks.
- Trigger will dispense foam in any position, no expensive gun required
- Use of carbon black for inherent color rather than black dye that fades
- 18 month shelf life
- Fish safe, non toxic formula



Scan Code for Video

See how Black Waterfall Foam can improve your waterfalls!



Buy 10 cases (120 cans) and SAVE!

Compare our foam density and fade resistance to the competitors.

### Foam Density



EasyPro®



Competitor

### Fade Resistance



EasyPro®



Competitor

Part #	Descriptions	Case Quantity	Stocking Code	Ship Weight	List Price
BWFN	20 ounce hand held foam	12	419496	2 lbs.	\$25.99



## Black 100% Silicone Sealant

Ideal for all types of uses when a water tight seal is needed

- Great for attaching face plates to skimmers and stone lips to the AquaFalls filters
- Sold in a 2.8 ounce squeeze tube for easy application (no caulk gun needed)



Part #	Case Quantity	Stocking Code	Ship Weight	List Price
BSN28	24	35626	1 lb.	\$7.49



## Pond and Waterfall Installation Kit

A combination of the most common items needed to install ponds and waterfalls

- Includes one can of EasyPro® Black Waterfall Foam, one tube of silicone, one can of PVC primer, one can of PVC cement and one 6" diameter liner patch
- WIK2 has two tubes of silicone and larger size can of PVC cement for installing large pond kits



Part #	Stocking Code	Ship Weight	List Price
WIK	350246	3 lbs.	\$66.99
WIK2	759993	4 lbs.	\$79.99



SINCE 1970

# Bog/Wetland Pond Filtration

## EasyBog™ Pond Filtration Cubes

EasyBog™ Cubes are media-filled Res-Cubes that are ideal for bog/wetland filtration systems. Traditional bogs are filled with gravel layers which are hard to clean. EasyBog™ Cubes use a plastic media which is not only easy to clean but has a very long life cycle.

- EasyBog™ Cubes have over 1000 sq ft of surface area to hold beneficial bacteria, creating a highly effective bio-filtration environment.
- Each cube filters up to 2500 gallons of pond water
- EasyBog™ Cubes come pre-assembled with media installed. Super fast and easy to install!
- Buy individually and build your own bog filter or buy complete kits below



EasyBog™ Cubes pictured without lids to show Bio Balls



**NEW HSCCLIP**  
Secure EasyBog™ Cubes Together

Part #	Description	Size	Filters up to	Stocking Code	Ship Weight	List Price
<b>EBC44</b>	EasyBog Cube filtration module	27" x 16" x 17½"	2500 gallons	2164993	28 lbs.*	\$219.99
<b>HSCCLIP</b>	<b>NEW</b> Res-Cube Clips (attach adjacent cubes) - each			7512	1 lb.	\$0.70** each



\*Dimensional shipping rate applies. \*\* Case price break when 30 or more are purchased

## EasyBog™ Small Pond Filtration Kits

EasyBog™ Kits are a fast and effective way to create a wetland pond filter for ponds up to 10,000 gallons. Not only are they effective at filtering, they are easy to backflush when cleaning is needed!

- Each kit includes 45 mil EPDM liner that has 3" heavy duty bulkhead fittings and water diffuser pipe pre-installed for a super fast bog build.
- Systems include connections for 2" or 3" schedule 40 PVC, or flexible PVC pipe. A check valve is recommended. Check valves: page 119. Flexible PVC pipe: page 116.
- EasyBog™ Cubes come pre-assembled with media installed. Super fast and easy to install!
- *Looking for wetland filtration for larger ponds? See our NEW Pit Viper™ Wetland Diffuser Modules and Wetland Filtration System on pages 42-43.*

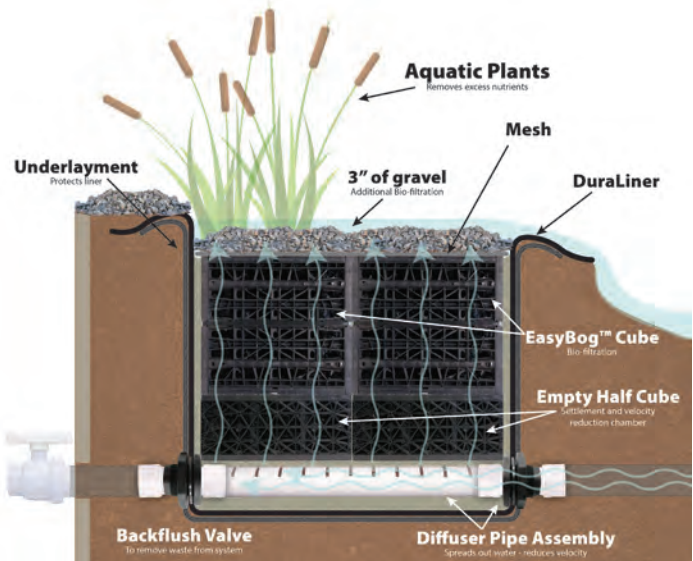

EBK1

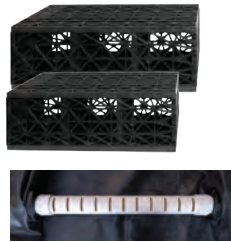

### EBK1 Kit includes:

- 10' x 12' 45 mil EPDM **DURALINER** with pre-installed bulkhead fittings and water diffuser pipe.
- 10' x 12' underlayment
- (2) HSC22 Half Res-Cubes
- (2) EBC44 EasyBog™ Cubes

### EBK2 Kit includes:

- 12' x 15' 45 mil EPDM **DURALINER** with pre-installed bulkhead fittings and water diffuser pipe.
- 10' x 15' underlayment
- (4) HSC22 Res-Cubes
- (4) EBC44 EasyBog™ Cubes



Side View

Diffuser Pipe Trench



EBK2

Part #	Description	Filters up to	Recommended Max Flow	Bog Dimensions	Stocking Code	Ship Weight	List Price
<b>EBK1</b>	EasyBog Filtration Kit	5000 gallons	10,000 gph	3' x 2.5' x 3' deep	2682491	47, 51, 57*	\$909.99
<b>EBK2</b>	EasyBog Filtration Kit	10,000 gallons	13,500 gph	3' x 5' x 3' deep	61192495	47, 47, 51, 51, 77*	\$1589.99

\*Dimensional shipping rate applies



# IN THE SWIM OF IT REC PONDS

Get in on the **industry's hottest trend!**

We've collaborated with **premier recreational pond builders** across the nation to bring you the **best of the best** in rec pond kits, components and a truly unique and innovative filtration system.

pages 41-43

Offer your customers a **more natural, environmentally friendly and aesthetically pleasing** alternative to traditional swimming pools.



Reflections Water Gardens (IL)



Ledman Lagoons (VA)

Rec ponds use natural wetland filtration to filter and purify the water, creating a **healthier, more sustainable ecosystem**. Because rec ponds don't use harsh chemicals like chlorine or bromine, they're gentler on skin, eyes and hair.

And there's no risk of chemical runoff into the surrounding environment

Designed with organic shapes, natural stone, and landscaping, swim ponds **blend naturally** into their surroundings, creating a beautiful, **serene setting** that provides an oasis for the homeowners. The natural surroundings can **promote relaxation and mental well-being**.



Reflections Water Gardens (IL)

**Self-sustaining ecosystem** when properly designed. The biological filtration system requires minimal maintenance.



## Recreational Swim Pond Kits

Kits designed to make your life much easier! Everything is included to create an enjoyable swim pond and wetland filtration system. Kits include our new Pit Viper™ Wetland Diffuser Modules and swim-rated pumps.

*Check out how the wetland filtration systems work on pages 42-43*

**New  
for 2025**



### 10' x 20' Kit Includes

- **DURALINER**®  
45 mil EPDM Rubber Liner
- 10 oz. Liner Underlayment
- (5) Pit Viper™ Diffuser Modules
- 1.65 hp SPVS165 Pump
- 25 EasyBog™ Cubes (with Media)
- 26 HSC44 Res-Cubes
- Wetland Cleanout Vault
- Intake Bay System
- Plumbing Package
- 2" Flow Meter
- Screen Mesh
- 5 lbs. EasyPro® Beneficial Bacteria



### 20' x 22' Kit Includes

- **DURALINER**®  
45 mil EPDM Rubber Liner
- 10 oz. Liner Underlayment
- (9) Pit Viper™ Diffuser Modules
- 2.7 hp SPVS270 Pump
- 63 EasyBog™ Cubes (with Media)
- 66 HSC44 Res-Cubes
- Wetland Cleanout Vault
- Intake Bay System
- Plumbing Package
- 3" Flow Meter
- Screen Mesh
- 5 lbs. EasyPro® Beneficial Bacteria

Part #	Pond Size	Pond Liner Size	Wetland Size (L x W x D)	Wetland Liner Size	Approx. Gallons	Intake Bay (L x W x D)	Pump Included	Stocking Code	Ship Weight	List Price
<b>RPK1020</b>	10' x 20' x 6'	35' x 50'	7' x 11.5' x 4'	25' x 22'	7,500	6' x 5' x 2'	SPVS165	611890463	1055 lbs.	\$15,901.09
<b>RPK2022</b>	20' x 22' x 6'	50' x 50'	10' x 21' x 4'	25' x 35'	17,000	7' x 8' x 2'	SPVS270	422357382	3200 lbs.	\$29,823.29



**Building a different size or shaped pond? Our team is here to help! Contact us for support.**

A well-designed swim pond can **increase property value**, especially for buyers who appreciate sustainable and eco-friendly features.



**New  
for 2025**

## Next Level Wetland Filtration - Simplified!

With our modular Pit Viper™ Diffusers and EasyBog™ Cubes, you can create a high-performance wetland filter with exceptional filtration while **saving time and money** in installation, labor and materials – no trenching, less liner, faster install and much less gravel!



**HOW DOES IT WORK?**

*Jake talks about this new system and why you need it.*



### NEW Pit Viper™ Diffuser Module

#### In Wetland Filters, Pit Viper™ Diffusers Deliver!

The innovative design of the Pit Viper Diffuser modules, allows them to fit and function seamlessly with EasyBog™ Cubes and Res-Cubes. The Pit Vipers create a slow, lateral flow of water in a wetland filter, allowing solids to settle. Water is then forced up through the EasyBog™ Cubes, encountering a massive amount of biological and mechanical filtration, resulting in a return of crystal clear water back into the pond for a healthy ecosystem that your customers will enjoy for years.



Pit Viper™ Wetland Diffuser Module  
**PV-CUBE**



Pit Viper™ Diffuser Connector  
**PV-COUP**



4" PVC to 10" Single Wall Pit Viper™ Connector  
**PV-CO410**



10" Pit Viper™ End Cap  
**PV-CAP10**



Intake Bay Vault 3" or 4" Plumbing  
**JAFIB3 / JAF1B4**



Cleanout Vault  
**JAFV**

**Safely power your rec pond**



Swim-rated pumps from EasyPro and Speck Pumps on page 114

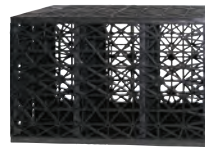

High Strength Res-Cube 27" x 16" x 17½"  
**HSC44**



EasyBog™ Cube 27" x 16" x 17½"  
**EBC44**



3" & 4" Check Valve & Intake Screen Assemblies  
**CVA301B / CVA401B**



Res-Cube Clips - **HSCCLIP**  
Res-Cube Mesh - **PN125**

Part #	Description	Stocking Code	Ship Weight	List Price
<b>PV-CUBE</b>	Pit Viper Wetland Diffuser Module (27" x 16" x 17.5")	6150802	18 lbs.*	\$196.09
<b>PV-COUP</b>	Pit Viper Diffuser Connector	326097	2 lbs.	\$35.99
<b>PV-CO410</b>	4" PVC to 10" Single Wall Connector of the Pit Viper	757274	2 lbs.	\$78.99
<b>PV-CAP10</b>	10" End Cap for the last Pit-Viper in the diffuser lateral	821025	2 lbs.	\$28.99
<b>JAFIB3</b>	Intake Bay Vault for recreational swimming pond - prepared for 3" plumbing	4299995	22 lbs.	\$399.99
<b>JAFIB4</b>	Intake Bay Vault for recreational swimming pond - prepared for 4" plumbing	5299997	22 lbs.	\$399.99
<b>JAFV</b>	Cleanout Vault for recreational swimming pond - see page 26 for detail	4299996	54 lbs.*	\$399.99
<b>HSC44</b>	Res-Cube, high strength - see page 27 for detail	946398	30 lbs.*	\$63.99** each
<b>EBC44</b>	EasyBog Cube Filtration Module - see page 39 for detail	2164993	28 lbs.*	\$219.99
<b>CVA301B</b>	3" Check Valve Assembly & Intake Screen Assembly for Intake Bay	795987	11 lbs.	\$123.69
<b>CVA401B</b>	4" Check Valve Assembly & Intake Screen Assembly for Intake Bay	3150905	18 lbs.	\$207.29
<b>HSCCLIP</b>	Res-Cube Clips (attach adjacent cubes) - each***	7512	1 lb.	\$0.70 each
<b>PN125</b>	Res-Cube Mesh with 1/8" holes - 48" x 50' roll	4158152	12 lbs.	\$197.69
<b>PN125F</b>	Res-Cube Mesh with 1/8" holes - 48" wide and cut to length	43726	—	\$4.65/foot

\*Dimensional shipping rate applies. \*\*Priced individually but sold in pairs only. Ship weight is for pair \*\*\* Case price break when 30 or more are purchased



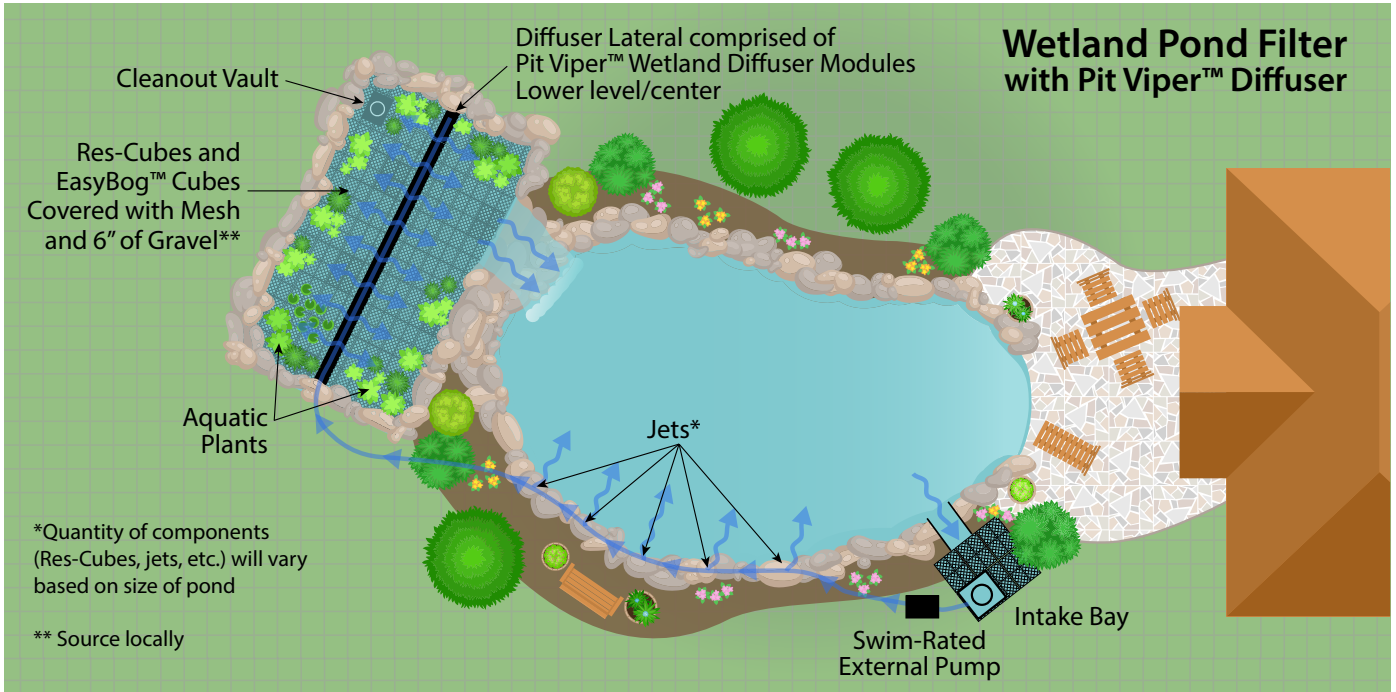

\*Quantity of components (Res-Cubes, jets, etc.) will vary based on size of pond

\*\* Source locally

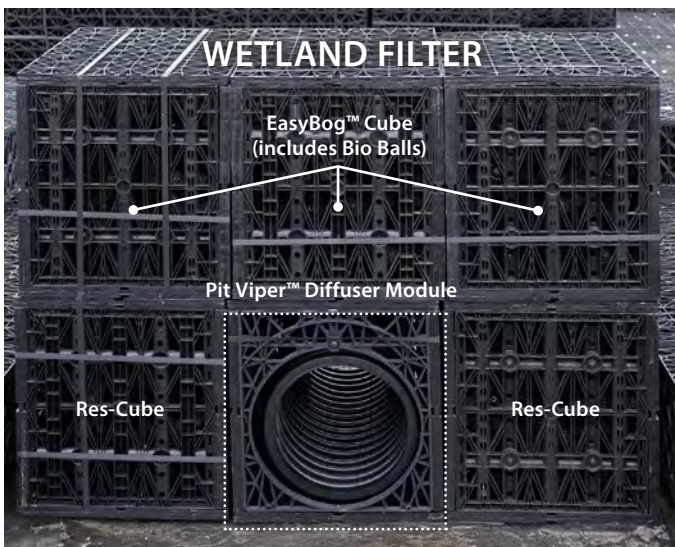

## Designing and Building a Wetland Filtration System

- 1 Start with a simple flat bottom reservoir - *no trench needed!*
- 2 Place Pit Viper™ Diffuser Modules end-to-end, to create a diffuser lateral up to 22.5' long (10 Pit Viper™ Modules). *For larger ponds, more than one diffuser lateral may be needed.*
- 3 Place empty Res-Cubes on both sides of the diffuser lateral, creating the first level. Clip cubes together.
- 4 Fill the second level with EasyBog™ Cubes. Clip these together and clip to the cubes in the first level, creating a stable structure.
- 5 Lay the plastic mesh over the cubes
- 6 Finish with 6" or more of gravel for additional filtration, a natural aesthetic, and as a base for aquatic plantings.

## Sizing a Wetland Filter

For optimum filtration, a wetland filter should be 20% to 40% of the surface area of the pond.

- 30% for ponds less than 50,000 gallons
- 25% for ponds over 50,000 gallon
- 600 gph per Pit Viper™ Diffuser Module
- Diffuser Lateral may be up to ten (10) Pit Viper™ Modules long (22.5'). Ten modules allows up to 6000 gph. Multiple inputs may be used when longer lengths are needed.
- 8' max width, or up to six (6) Res-Cubes between each diffuser lateral.



Installation is faster and easier with lightweight, modular components



## Cross Section of a Pond Kit



**\*ProTip** Covering liner with rocks and gravel provides additional surface area for beneficial bacteria and also hides and protects liner. Rocks and gravel look more natural than bare liner.

## Pond Kit Comparison Chart

Part #	Pond Size	Liner Size	Gallons in Pond	Skimmer	Filter	Pump	Flex Pipe	Pump Warranty
<b>ECO-SERIES Pond Kits</b>								
EPK66	6' x 6' x 2' deep	10' x 13'	400	PS4E	WF10E	EP1750	1/4" x 25'	3 years
EPK810	8' x 10' x 2' deep	15' x 15'	900	PS6E	WF18E	TLS1850	1/2" x 25'	1 1/2 years
EPK1015	10' x 15' x 2' deep	17' x 20'	1700	PS6E	WF29E	TLS2750	2" x 25'	1 1/2 years
EPK1520	15' x 20' x 2' deep	22' x 25'	3400	PS10E	WF60E	TLS4250	2" x 25'	1 1/2 years
<b>PRO-SERIES™ Mini Pond Kits</b>								
ET66FB	6' x 6' x 2' deep	10' x 10'	400	PSMFB	AT	TLS1850	1/4" x 25'	1 1/2 years
ET610FB	6' x 10' x 2' deep	10' x 14'	675	PSMFB	AT	TLS2750	1/4" x 25'	1 1/2 years
ET811FB	8' x 11' x 2' deep	12' x 15'	1000	PSMFB	AT	TLS2750	1/4" x 25'	1 1/2 years
<b>PRO-SERIES™ Small Pond Kits</b>								
ES66FB	6' x 6' x 2' deep	10' x 10'	400	PSMFB	AS	EP2200	1/2" x 25'	3 years
ES611FB	6' x 11' x 2' deep	10' x 15'	750	PSMFB	AS	EP2200	1/2" x 25'	3 years
ES811FB	8' x 11' x 2' deep	12' x 15'	1000	PSMFB	AS	EP2200	1/2" x 25'	3 years
ES11AFB	11' x 11' x 2' deep	15' x 15'	1400	PS1FB	AS	TH150	1/2" x 25'	2 years
ES16AFB	11' x 16' x 2' deep	15' x 20'	2000	PS1FB	AS	TH150	1/2" x 25'	2 years
<b>PRO-SERIES™ Medium Pond Kits</b>								
EM1116FB	11' x 16' x 2' deep	15' x 20'	2000	PS1FB	AM	TH250	2" x 25'	2 years
EM1616FB	16' x 16' x 2' deep	20' x 20'	2900	PS1FB	AM	TH250	2" x 25'	2 years
EM1621FB	16' x 21' x 2' deep	20' x 25'	3800	PS1FB	AM	TH400	2" x 50'	2 years
EM2121FB	21' x 21' x 2' deep	25' x 25'	4950	PS1FB	AM	TH400	2" x 50'	2 years
EM2126FB	21' x 26' x 2' deep	25' x 30'	6150	PS1FB	AM	TH400	2" x 50'	2 years
<b>PRO-SERIES™ Large Pond Kits</b>								
EL2424	24' x 24' x 3' deep	30' x 30'	10,000	PS2FB	AL	TM9500	3" x 50'	2 years
EL2434	24' x 34' x 3' deep	30' x 40'	13,500	PS2FB	AL	TM13500	3" x 50'	2 years
EL3434	34' x 34' x 3' deep	40' x 40'	18,000	PS2FB	AL	TM13500	3" x 75'	2 years

**Custom designs are our specialty**

Due to the unique nature of many pond and waterfall applications, projects are often custom-designed.

Simply send us a drawing of your project and we'll be happy to help you plan your water feature!

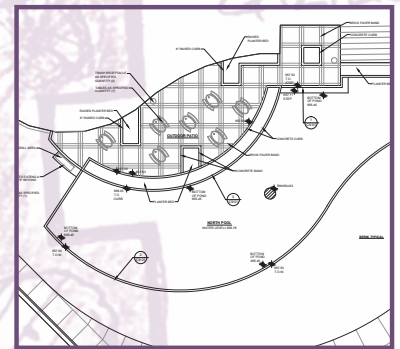

This is an example of a large pond kit. Kits can be customized to your exact needs!

## ECO-Series® Pond Kits

### An excellent value!

Each kit includes all necessary items to build a top quality feature. See chart below for exact sizes on pumps, skimmers, filters, etc.

#### Kits Include

- **DURALINER.** 45 mil EPDM rubber liner
- Liner underlayment
- Eco-Series skimmer
- Eco-Series filter with media
- Continuous duty pump
- Check valve assembly
- Flexible PVC pipe
- PVC glue



**Perfect DIY Kit!**

EPK810



EPK1520 ships motor freight

Part #	Pond Size*	Liner Size	Approx. Pond Gallons	Skimmer Included	Filter Included	Pump Included	Pump Warranty	Flex Pipe	Stocking Code	Ship Weight	List Price
EPK66	6' x 6'	10' x 13'	400	Prelude	Prelude	EP1750	3 years	1 1/4" x 25'	2644147	94 lbs.	\$863.59
EPK810	8' x 10'	15' x 15'	900	Melody	Sonata	TLS1850	18 mo.	1 1/2" x 25'	6977402	53, 98 lbs.	\$1310.99
EPK1015	10' x 15'	17' x 20'	1700	Melody	Melody	TLS2750	18 mo.	2" x 25'	31247777	85, 128 lbs.	\$1675.09
EPK1520	15' x 20'	22' x 25'	3400	Ovation	Symphony	TLS4250	18 mo.	2" x 25'	81848559	428 lbs.	\$2482.79

\*Pond size is based on a 2' depth

Recommended Accessories for Kits on This Page: Underwater Lighting, Auto Fill Valves, Bacteria & Water Treatments



## PRO-SERIES™ Mini Pond Kits

**Great  
DIY Kit!**

### Ideal for Retail Sales

Mini pond kits have everything a do-it-yourselfer needs to build a beautiful, long lasting water feature with professional grade products.

- **DURALINER.** 45 mil EPDM rubber liner
- Liner underlayment
- Mini skimmer with filter brushes
- Mini AquaFalls filter with molded rock lip
- 25' of 1 1/4" PVC flex pipe
- 1 1/4" check valve assembly
- Silicone sealer and PVC glue
- Continuous duty pump



ET811FB



Part #	Pond Size*	Liner Size	Approx. Pond Gallons	Skimmer Included	Filter Included	Pump Included	Pump Warranty	Stocking Code	Ship Weight	List Price
ET66FB	6' x 6'	10' x 10'	400	PSMFB	AT	TLS1850	18 mo.	6896397	50, 46 lbs.	\$1198.39
ET610FB	6' x 10'	10' x 14'	675	PSMFB	AT	TLS2750	18 mo.	8971541	58, 47 lbs.	\$1299.89
ET811FB	12' x 15'	8' x 11'	1000	PSMFB	AT	TLS2750	18 mo.	21016767	69, 47 lbs.	\$1361.39

\*Pond size is based on a 2' depth

Recommended Accessories for Kits on This Page: Underwater Lighting, Auto Fill Valves, Bacteria & Water Treatments

## PRO-SERIES™ Small Pond Kits

### Everything you need is included!

All components are top quality and long lasting, providing years of enjoyment!

#### UV Option

The ES11AFB and ES16AFB pond kits include the PS1FB skimmer which has an optional UV upgrade when filter brushes are used, see page 33 for more information.

### All "ES" Kits Include

- Pro-Series small AquaFalls filter/waterfall base
- Pro-Series skimmer with filter brushes
- Energy efficient submersible pump
- **DURALINER.** 45 mil EPDM rubber liner
- Liner underlayment
- Beneficial bacteria
- 25' of 1 1/2" flex PVC pipe
- Check valve assembly, fittings and instructions
- Three mini LED lights with 45 watt transformer
- Waterfall installation kit (pvc glue, primer, silicone, black foam)



ES11AFB



Part #	Pond Size**	Liner Size	Approx. Pond Gallons	Skimmer Included	Filter Included	Pump Included	Pump Warranty	Stocking Code	Ship Weight	List Price
ES66FB*	6' x 6'	10' x 10'	400	PSMFB	AS	EP2200	3 years	61299421	50, 76 lbs.	\$1735.79
ES611FB*	6' x 11'	10' x 15'	750	PSMFB	AS	EP2200	3 years	31355957	66, 76 lbs.	\$1812.69
ES811FB*	8' x 11'	12' x 15'	1000	PSMFB	AS	EP2200	3 years	61389865	69, 76 lbs.	\$1858.89
ES11AFB*	11' x 11'	15' x 15'	1400	PS1FB	AS	TH150	2 years	31762284	90, 110 lbs.	\$2356.89
ES16AFB*	11' x 16'	15' x 20'	2000	PS1FB	AS	TH150	2 years	41847073	90, 140 lbs.	\$2472.29

\*Dimensional shipping rate applies \*\*Pond size is based on a 2' depth



# Pond Kits



EM1621FB

## PRO-SERIES™ Medium Pond Kits

"Love using EasyPro filters and skimmers for pond installations! Great brand, reputation and company to work with!"  
Brian A.

### All "EM" Kits Include

- **DURALINER.** 45 mil EPDM rubber liner
- Liner underlayment
- Medium AquaFalls filter/waterfall base
- PS1FB skimmer
- EasyPro® TH Pump with two year warranty
- Beneficial bacteria
- 2" flexible PVC pipe
- Check valve assembly
- Three mini LED lights with 45 watt transformer
- Installation kit which includes PVC primer, glue, liner patch, silicone and black foam



All EM pond kits ship complete on one pallet

All Medium Pond Kits include our medium AquaFalls Filter and PS1FB Skimmer for increased filtering capacity over the small pond kits on page 45.

Part #	Pond Size*	Liner Size	Approx. Pond Gallons	Skimmer Included**	Filter Included	Pump Included	Pump Warranty	Stocking Code	Ship Weight	List Price
EM1116FB	11' x 16'	15' x 20'	2000	PS1FB	AM	TH250	2 years	32124959	290 lbs.	\$2842.79
EM1616FB	16' x 16'	20' x 20'	2900	PS1FB	AM	TH250	2 years	42238004	310 lbs.	\$2996.69
EM1621FB	16' x 21'	20' x 25'	3800	PS1FB	AM	TH400	2 years	32518483	370 lbs.	\$3373.89
EM2121FB	21' x 21'	25' x 25'	4950	PS1FB	AM	TH400	2 years	72685802	400 lbs.	\$3600.89
EM2126FB	21' x 26'	25' x 30'	6150	PS1FB	AM	TH400	2 years	82827119	430 lbs.	\$3793.29

\*Pond size is based on a 2' depth

\*\*EM pond kits come standard with PS1FB skimmer (filter brushes). For a skimmer with filter pad - drop letters "FB" from part number

Recommended Accessories for Kits on This Page: Underwater Lighting, Auto Fill Valves, Bottom Drains, Bacteria & Water Treatments

## PRO-SERIES™ Large Pond Kits

### All "EL" Kits Include

- **DURALINER.** 45 mil EPDM rubber liner
- Liner underlayment
- 9,000 gph or larger submersible pump
- 3" check valve assembly
- 3" flexible PVC pipe
- One gallon beneficial pond bacteria (ASB128)
- Four underwater lights with transformer
- WIK2 installation kit which includes PVC primer, glue, liner patch, black foam and two tubes of silicone

EL3434



**Pro Tip**

Bottom Drains are strongly recommended in large ponds to prevent stratification.

See EBD4 on page 50.



Part #	Pond Size*	Liner Size	Approx. Pond Gallons	Skimmer Included**	Filter Included	Pump Included	Pump Warranty	Stocking Code	Ship Weight	List Price
EL2424	24' x 24'	30' x 30'	10,000	PS2FB	AL	TM9500	18 mo.	84344192	695 lbs.	\$5819.29
EL2434	24' x 34'	30' x 40'	13,500	PS2FB	AL	TM13500	18 mo.	84813991	360, 450 lbs.	\$6454.69
EL3434	34' x 34'	40' x 40'	18,000	PS2FB	AL	TM13500	18 mo.	95419764	510, 480 lbs.	\$7275.49

\*Pond size is based on a 3' depth

\*\*EL pond kits come standard with PS2FB skimmer (filter brushes). For a skimmer with filter pad - drop letters "FB" from part number





## PRO-SERIES™ Check Valve Assemblies

Part #	Size	Compatible Pump Models	Fits	Stocking Code	Ship Weight	List Price
CVA12EP	1¼"	EP2200	PSM	759243	2 lbs.	\$78.99
CVA12TG	1¼"	TLS1850, TLS2750	PSM	359247	2 lbs.	\$78.99
CVA15EP	1½"	EP2200, EP3200N	PSM	859244	2 lbs.	\$78.99
CVA15TGM	1½"	All TLS style pumps	PSM	462248	2 lbs.	\$82.99
CVA15THM	1½"	TH150	PSM	663747	2 lbs.	\$84.99
CVA15TG	1½"	All TLS style pumps	PSA5000 & 7000, PS1, JAFM, JAFL	662249	2 lbs.	\$82.99
CVA15TH	1½"	TH150	PSA5000, PS1, JAFM, PV60E, JAFL	963744	4 lbs.	\$84.99
CVA20TH	2"	TH150, TH250, TH400, TH750	PSA5000 & 7000, PS1, JAFM, PV60E, JAFL	189992	4 lbs.	\$119.99
CVA30EP2	3"	All TM, TB, WQ Pumps	PS2, JAFV	2172494	9 lbs.	\$229.99
CVA30K*	3"	TB8000, TM9500, TB12000**, TM13500**	PSA9000 & 11000	3179994	10 lbs.	\$239.99

\*Assembly is cut to length on-site and male adapter glued on, check valve installs outside skimmer

\*\*These pumps can be used only in applications where the operating head pressure reduces flow under 11000 gph (skimmer capacity)

## ECO-Series® Check Valve Assemblies

Part #	Size	Compatible Pump Models	Fits	Stocking Code	Ship Weight	List Price
SCVA1217	1¼"	EP1750	PS4E	652493	2 lbs.	\$69.99
SCVA12PS	1¼"	EP850, EP1050, EP1350	PS4E	352496	2 lbs.	\$69.99
SCVA12MS	1¼"	EP2200, EP3200N	PS6E	752498	2 lbs.	\$69.99
SCVA12TG	1¼"	TLS1850, TLS2750	PS6E, JAFL	852493	2 lbs.	\$69.99
SCVA15MS	1½"	EP2200, EP3200N	PS6E	353998	2 lbs.	\$71.99
CVA15TG	1½"	All TLS style pumps	PS6E, PV60E	662249	2 lbs.	\$82.99
SCVA15PV	1½"	EP2200, EP3200N	JAFL, PV60E, JAFM, PS1	353994	2 lbs.	\$71.99
SCVA20MS	2"	TH150, TH250, TH400	PS6E	984749	4 lbs.	\$112.99
SCVA2047V*	2"	EPA4500, EPA5500, EPA6500	JAFL, PS1, PS6E	758493	4 lbs.	\$77.99
SCVA20TE	2"	TH400, TH750	PS10E	384748	5 lbs.	\$112.99
SCVA2067	2"	EPA4500, EPA5500, EPA6500	PS10E	986992	5 lbs.	\$115.99
SCVA2097	2" x 3"	EPA5500, EPA6500, EPA9500	PS10E	293748	6 lbs.	\$124.99
SCVA30PS	3"	TB8000	PS10E	3149994	9 lbs.	\$199.99

\*Female thread at pump connection

## Recreational Swim Pond Intake Bay Check Valve Assemblies

Part #	Size	Compatible Pump Models	Fits	Stocking Code	Ship Weight	List Price
CVA30IB	3"	External Pumps on pages 111-114	JAFIB3 on page 43	795987	11 lbs.	\$123.69
CVA40IB	4"	External Pumps on pages 111-114	JAFIB4 on page 43	3150905	18 lbs.	\$207.29



## Pump Outlet Assemblies

In many applications a check valve is not needed on the pump outlet. Especially on small Just-A-Falls kits. These assemblies are designed for use on pumps used inside EasyPro® pump vaults.

Part #	Size	Compatible Pump Models	Fits	Stocking Code	Ship Weight	List Price
PDA12EP	1¼"	EP2200	JAFT	823249	1 lb.	\$30.99
PDA12TG	1¼"	TLS1850, TLS2750	JAFT	923248	1 lb.	\$30.99
PDA125	1¼"	EP2200, EP3200N	JAFT	425496	1 lb.	\$33.99
PDA155	1½"	TLS1850, TLS2750	JAFT	722496	1 lb.	\$29.99
PDA15EP	1½"	EP2200, EP3200N	JAFL, PV60E, JAFM	624741	1 lb.	\$32.99
PDA15TG	1½"	All TLS style pumps	JAFL, PV60E, JAFM	322497	1 lb.	\$29.99
PDA20EP	2"	EPA4500, EPA5500, EPA6500	JAFL	324748	1 lb.	\$32.99
PDA20TH	2"	TH150, TH250, TH400, TH750	JAFL, PV60E, JAFM	829247	2 lbs.	\$38.99
PDA3097	2" x 3"	EPA5500, EPA6500, EPA9500	JAFV	745749	3 lbs.	\$60.99
PDA3016	3"	All TM, TB, WQ pumps	JAFV	647992	5 lbs.	\$63.99





SINCE 1970

# Water Fill Valves & Box

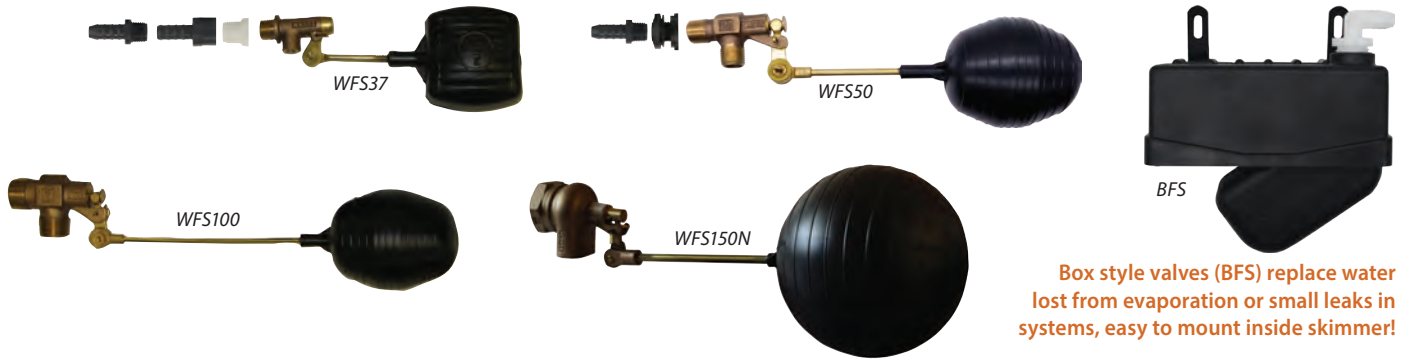

Box style valves (BFS) replace water lost from evaporation or small leaks in systems, easy to mount inside skimmer!

## Water Fill Valves

### Brass Fill Valves

- Ideal for use in skimmers, vaults and the water fill box (below) for maintaining water levels in many different applications
- Heavy duty brass body and brass rods are far superior to normal plastic fill valves
- All valve rods (arms) can be adjusted to fit your exact requirements
- WFS37 and WFS50 include fittings to connect to irrigation tubing

### Box Style Fill Valve (BFS)

This durable fill valve is ideal since the float is contained inside the valve box. No chance of damaging unit when lifting pumps in or out of skimmer.

- Recommended water pressure 35 psi
- Includes fitting to connect to 1/2" vinyl tubing
- Fits in small or large skimmer
- Measures 7 1/2" long x 3" wide x 4" high

Part #	Description	Overall Length	Gpm Flow at Psi:		Stocking Code	Ship Weight	List Price
			15	35			
BFS	1/2" box style fill valve	7 1/2"	6	5	732992	2 lbs.	\$43.99
WFS37	1/2" economy brass valve	8"	11	16	247998	2 lbs.	\$63.99
WFS50	1/2" brass fill valve	12 1/2"	12 1/2	17 1/2	874991	2 lbs.	\$99.99
WFS100	1" brass fill valve	17"	38	64	8101246	3 lbs.	\$134.99
WFS150N	1 1/2" brass fill valve	19 1/2"	90	129	6224998	5 lbs.	\$299.99



Water fill valves may require inline pressure regulator to keep pressures below recommended limits

## PRO-SERIES™

### Water Fill Box

Ideal for auto fills inside ponds, Just-A-Falls systems and formal pools!

- A good way to mount a water fill valve in a pond without a skimmer
- Provides an ideal housing in which to install an auto fill, 1/2" bulkhead included
- Sits inside the liner and holds fill valves up to 13" long
- 1" overflow bulkhead is included for optional overflow drain
- Auto fill valve sold separately



Designed to house WFS37 and WFS50 fill valves (sold separately above)



Sinacori Landscape (MI)



Part #	Description	Stocking Code	Ship Weight	List Price
WFB	15" long x 8" x 8"	867493	4 lbs.	\$89.99



# Bottom Drains



SINCE 1970



Many pond builders have found that adding a bottom drain helps keep a pond cleaner. Fish waste and other muck that accumulate on a pond bottom can be easily removed by a bottom drain.

Huisman Landscape (MI)

## 3" Bottom Drains

- Available with (BDA) or without (BD1) air diffuser in lid, using air increases circulation and cleaning capacity
- Both have dual rubber gaskets and six stainless screws for water tight penetration through liner
- For use with 3" schedule 40 PVC fittings and pipe
- BDA has 1/2" barbed inlet fitting, recommended air flow through diffuser is .5 - 1.5 cfm
- **Drain Kits** are designed to connect bottom drain into skimmer box and include bottom drain, 2" bulk head fitting, 2" valve and fittings (flex pipe sold separately, see page 116)

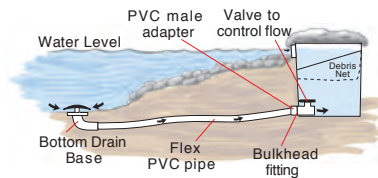

Part #	Description	Stocking Code	Ship Weight	List Price
BD1	3" bottom drain	396298	4 lbs.	\$128.38
BDA	3" bottom drain with air diffuser	6122997	5 lbs.	\$163.99
BDK2N	Bottom drain kit with BD1 drain	7157494	7 lbs.	\$209.99
BDK2A	Bottom drain kit with BDA drain including air diffuser	3177321	8 lbs.	\$236.43



## 4" Bottom Drains

Heavy duty, roto-molded design offers superior strength

- Threaded center stand pipe securely attaches dome lid to base
- Sixteen stainless screws securely attach liner ring to base with water tight seal through liner
- For use with 4" schedule 40 PVC fittings and pipe, use 4" male adapter (MA40) to connect to 4" pipe, use reducing male adapter (RMA4030) to connect to 3" pipe
- EBD4A incorporates an air diffuser into the dome lid — incoming air is delivered up through the center stand pipe allowing air tubing to be installed under liner
- EBD4A tubing adapter is 1/2", recommended air flow through diffuser is .5 - 1.5 cfm
- **Drain Kits** are designed to connect bottom drain into skimmer box and include bottom drain, 3" bulk head fitting, 3" valve and fittings (flex pipe sold separately, see page 116)

### Easy Installation

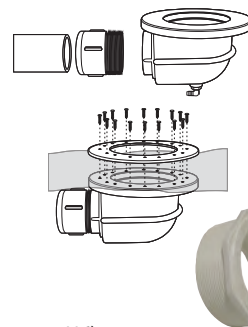

Part #	Description	Stocking Code	Ship Weight	List Price
EBD4	4" heavy duty bottom drain	9149999	10 lbs.	\$199.99
EBD4A	4" bottom drain with air diffuser	8187492	12 lbs.	\$249.99
BDK3N	Bottom drain kit with EBD4 drain	7202496	14 lbs.	\$269.99
BDK3A	Bottom drain kit with EBD4A drain including air diffuser	4224993	15 lbs.	\$299.99
RMA4030	4" threaded x 3" slip PVC adapter	812346	1 lb.	\$18.99



## Pump Pro-Tectors

Protect against plugging by creating a large surface area around the pump

- Designed to fit all brands of small pumps
- Has a polyester filter media pad inside of a nylon mesh bag
- Drawstring top with push button release keep the top closed around the pump yet makes for easy pump removal
- **PP8** has an 8" diameter and 1" thick sidewalls allowing pumps up to 6" diameter
- **PP12** has a 12" diameter and has 2" thick sidewalls allowing pumps up to 8" diameter



PP8

PP12

Part #	Max. gph Flow	Case Quantity	Stocking Code	Ship Weight	List Price
PP8	1250	6	323625	2 lbs.*	\$31.49
PP12	1250	4	433741	3 lbs.*	\$44.99



\*Dimensional shipping rate applies

## Folding, Telescoping Pond Net

Great all-around pond net for skimming leaves, catching fish, etc.

- Aluminum frame and handle are light weight and very strong
- Net measures 13" x 18" x 16" deep mesh and is flat along the front making it easier to catch fish
- 27" - 47" telescoping handle is super strong and folds for storage.
- Soft, 1/4" fish safe mesh

**New Improved Design**



Part #	Description	Case Quantity	Stocking Code	Ship Weight	List Price
EPFN	Telescoping pond net	6	637493	2 lbs.	\$49.99



## Fish Shipping Bags

- Most commonly used for hauling live fish
- Bags are made from the finest materials
- Our standard bag is 18" x 34", 3 mil and guaranteed waterproof
- Available in 100 or 250 count box

Part #	Description	Stocking Code	Ship Weight	List Price
OB100	18" x 34" bag, 100 count box	855195	12 lbs.	\$73.59
OB250	18" x 34" bag, 250 count box	3122478	31 lbs.	\$163.29



## Bander & Bands

Use this handy tool to quickly and securely close your fish shipping bags. For maximum holding power use two bands at a time on each bag.

Part #	Description	Stocking Code	Ship Weight	List Price
BBT	Bag sealing tool	431705	2 lbs.	\$45.29
BB	Bands, 100 ct. bag	75526	1 lb.	\$7.89





## EasyPro is now a Master Distributor of CAST & CAST SOURCE Landscape Lighting!

Looking for a CAST OR CAST SOURCE PRODUCT NOT SEEN HERE?  
We can drop-ship any CAST Lighting product.



CL-SBL10



CL-SUL20



CL-SFL10



CL-MLWL



CL-AB18



CL-AL675



CL-PSMR16



CL-CCSL



CL-WL



CL-WWCC



CL-OBTCC

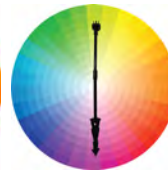

CL-BTEX

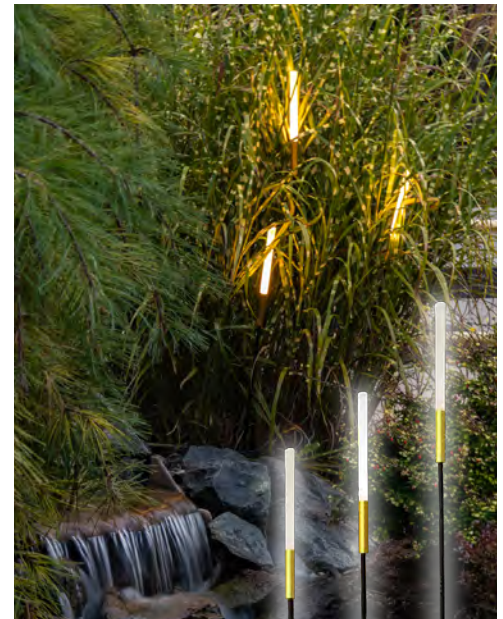

CL-BBL3  
2 Watt Bamboo Lights  
Aluminum Stem with  
Black Polyester Coated,  
Textured Finish



### EXPAND YOUR LIGHTING SOLUTIONS



Source Lighting® is professional grade landscape lighting made with the highest quality materials by CAST, the manufacturer of the world's most durable outdoor lighting. All fixtures are backed by industry-leading warranties.

Part #	Description	Fixture Size Ht. x Diameter	Housing	Beam Angle	Lead Wire	Bulb Included	Stocking Code	Ship Weight	List Price
CL-BBL3	Bamboo Lights, three pack, 24", 36", 44"	12" x 11/16"	SS	120°	36" #18-2	Yes	3208874	4 lbs.	\$278.49
CL-BBL3K	Bamboo Light Kit, three pack, 24", 36", 44", Transformer**	12" x 11/16"	SS	120°	36" #18-2	Yes	3285367	9 lbs.	\$380.49
CL-SBL10	Spotlight - MR16	5.1" x 2.25"	Brass	Adj.	3' 18AWG	No	456273	1 lb.	\$75.03
CL-SUL20	Underwater Light - MR16	4.614" x 5.362"	Brass	Adj.	25' 18AWG	No	7145726	4 lbs.	\$194.29
CL-SFL10	Mini Flood Wash Light	4" x 3.8"	Brass	Adj.	5' 16AWG	No	8722208	2 lbs.	\$96.27
CL-MLWL	Engineered Wall Light Multi Light Level	1" x 6"	Brass	Down	48" 18AWG	Yes	387292	1 lb.	\$116.39
CL-AB18	Area light 18" Stem	18" tall	Brass	—	25' 16AWG*	No	584006	3 lbs.	\$112.00
CL-AL675	Area Light 6.75" Flat Top Hat	6.75" dia.	Brass	—	—	—	849783	2 lbs.	\$66.37
CL-PSMR16	Porch/Sconce Up and Down Light - MR16	7" x .5"	Brass	Up/Dwn	25' #16-2	No	5129532	3 lbs	\$172.71
CL-CCSL	Color Control Spotlight MR16- 105° rated lead wire	7" x 3"	Brass	Adj.	6' 18#-2	Integrated	6252943	4 lbs.	\$337.25
CL-WL	Color Control Wall Light - 105° rated lead wire	1" x 6"	Copper	80°	6' 18#-2	Integrated	2133196	2 lbs.	\$177.58
CL-WWCC	Color Control Wall Wash- 105° rated lead wire	5" x 5.25	Brass	20°-80°	6' 18#-2	Integrated	6299424	4 lbs.	\$399.23
CL-OBTCC	Orange Bluetooth Color Control Bulb - MR16	—	—	—	—	—	489963	1 lb.	\$119.95
CL-BTEX	Bluetooth Range Extender	—	—	—	—	—	393933	2 lbs.	\$125.24

\* CL-AB18 includes 25 ft. Lead Wire #16 AWG Brown with 18in. Daisy Chain Whip \*\* Includes EPT45 Transformer



## CAST Accessories and Replacement Parts



CL-BSRK



CL-FMFCB



CL-BFMCS



CL-TMRC / CL-SSTMHK



CL-CTPC



CL-ASTROT



CL-300T



CL-150T



CL-RMR1640  
CL-RMR1655  
CL-RMR1680



CL-GMR1620  
CL-GMR1630  
CL-GMR1640  
CL-GMR1655  
CL-GMR1680



CL-BMR1620  
CL-BMR1630  
CL-BMR1640  
CL-BMR1655  
CL-BMR1680



CL-G4B2.5

Part #	Description	Compatible with	Stocking Code	Ship Weight	List Price
CL-BSRK	#12-10 Direct Burial Butt Splice Repair Kit	(1) at #10, (2) at #12, (3) at #14, (5) at #16, (5) at #18	43354	1 lb.	\$4.47
CL-FMFCB	Floor Mount Canopy Threaded	CL-SBL10, CL-SFL10, CL-AB18, CL-BTEX	418675	1 lb.	\$24.89
CL-BFMCS	Bronze Floor Mount Canopy Socket & Set Screw	CL-CCSL, CL-WWCC	528128	1 lb.	\$37.49
CL-SSTMHK	Stainless Tree Mount Hardware Kit	CL-TMRC	811124	1 lb.	\$14.83
CL-TMRC	Tree Mount Replacement Canopy	CL-CCSL, CL-WWCC	426283	1 lb.	\$35.04
CL-CTPC	Transformer Photo Cell w/ Quick Connect Adapter	CL-150T, CL300T	347245	1 lb.	\$62.99
CL-ASTROT	Digital Astronomical Transformer Time Clock 7-day	CL-150T, CL300T	450996	1 lb.	\$67.99
CL-300T	Transformer Journeyman 300 VA Stainless Steel	12V-15V Low Voltage Fixtures	6374828	16 lbs.	\$499.76
CL-150T	Transformer Journeyman 150 VA Stainless Steel	12V-15V Low Voltage Fixtures	5307165	16 lbs.	\$409.55
CL-LVW250	Low Voltage 12-2 Tin Coated Lighting Wire, 250' Roll	All Low Voltage Fixtures	7280434	21 lbs.	\$373.90
CL-LVWF	Low Voltage 12-2 Tin Coated Lighting Wire, per ft.	All Low Voltage Fixtures	41279	—	\$1.69/ft.

**Warm White Bulbs** Color named below is the housing color, not bulb color. Bulbs are color-coded according to wattage.

CL-RMR1640	MR16 40' Deg. Bulb (Red) 1 Watt 10 Watt Equivalent	Any MR16 Style Fixtures	323866	1 lb.	\$31.81
CL-RMR1655	MR16 55' Deg. Bulb (Red) 1 Watt 10 Watt Equivalent	Any MR16 Style Fixtures	623868	1 lb.	\$31.81
CL-RMR1680	MR16 80' Deg. Bulb (Red) 1 Watt 10 Watt Equivalent	Any MR16 Style Fixtures	823866	1 lb.	\$31.81
CL-GMR1620	MR16 20' Deg. Bulb (Green) 2 Watt 20 Watt Equivalent	Any MR16 Style Fixtures	523865	1 lb.	\$31.81
CL-GMR1630	MR16 30' Deg. Bulb (Green) 2 Watt 20 Watt Equivalent	Any MR16 Style Fixtures	723863	1 lb.	\$31.81
CL-GMR1640	MR16 40' Deg. Bulb (Green) 2 Watt 20 Watt Equivalent	Any MR16 Style Fixtures	323862	1 lb.	\$31.81
CL-GMR1655	MR16 55' Deg. Bulb (Green) 2 Watt 20 Watt Equivalent	Any MR16 Style Fixtures	923862	1 lb.	\$31.81
CL-GMR1680	MR16 80' Deg. Bulb (Green) 2 Watt 20 Watt Equivalent	Any MR16 Style Fixtures	423865	1 lb.	\$31.81
CL-BMR1620	MR16 20' Deg. Bulb (Blue) 4 Watt 35 Watt Equivalent	Any MR16 Style Fixtures	526168	1 lb.	\$34.88
CL-BMR1630	MR16 30' Deg. Bulb (Blue) 4 Watt 35 Watt Equivalent	Any MR16 Style Fixtures	826162	1 lb.	\$34.88
CL-BMR1640	MR16 40' Deg. Bulb (Blue) 4 Watt 35 Watt Equivalent	Any MR16 Style Fixtures	326165	1 lb.	\$34.88
CL-BMR1655	MR16 55' Deg. Bulb (Blue) 4 Watt 35 Watt Equivalent	Any MR16 Style Fixtures	726167	1 lb.	\$34.88
CL-BMR1680	MR16 80' Deg. Bulb (Blue) 4 Watt 35 Watt Equivalent	Any MR16 Style Fixtures	526162	1 lb.	\$34.88
CL-G4B2.5	Bi-Pin G4 Bulb, 2.5 Watts 2.5 Watt 20 Watt Equivalent	CL-AB18, CL-SFL10	721029	1 lb.	\$28.02



**Rock-Shaped!  
Easy to Hide**



## Extra Bright, Warm White Mini LED Lights

The small 1½" diameter light fixture is rock shaped which makes hiding them easy.

- Low voltage lights are smaller than a golf ball and yet have an incredibly bright output with 16 diodes.
- Each 1.25 watt light has 15' power cord with quick connect plug cord ends for easy connection to MT10, MT20 or EPT45 transformers on page 59.
- **One year warranty**

Part #	Lights Included	Transformer Included	Case Quantity	Stocking Code	Ship Weight	List Price
LED2W	2	—	6	759991	2 lbs.	\$79.99
LED2K	3	MT10	4	297490	4 lbs.	\$129.99



## 4 Watt, Warm White LED Rock Light

Realistic rock cover is molded from actual rock for a natural look that blends into the landscape of ponds, waterfalls and gardens. Stainless steel housing for long life. Safe for chlorine and salt water. May be used in or out of the water. Designed with an added flat surface to angle beam upward if desired.

- 3.75" tall x 5.5" wide, 3.25" deep
- Diodes: Super bright CREE diodes proudly made in the USA
- Light temperature: 2800K warm white
- Color rendering index: 87
- Light angle: 22°
- Bulb life: up to 60,000 hours
- Power cord: 16' with 12V quick connect plug
- **Three year warranty**

Part #	Lights Included	Transformer Included	Case Quantity	Stocking Code	Ship Weight	List Price
LED4RL	1	—	4	979497	3 lbs.	\$105.99

Transformer is required for use but is not included. Compatible transformers: MT10 (2 lights), MT20 (4 lights) or EPT45 (up to 8 lights). See page 59.



## 3 Watt, Warm White LED Light

- 2800-3000 K warm white
- Cast aluminum housing and removable stand
- 3" tall x 1½" dia., 3" dia. base
- Equivalent of 20 watt halogen bulb
- Each light has a 15' power cord with quick connect plug cord ends for easy connection to MT10, MT20 or EPT45 transformers on page 59.
- **Two year warranty**



Removable Stand



Part #	Lights Included	Transformer Included	Case Quantity	Stocking Code	Ship Weight	List Price
LED4WW	1	—	6	267491	2 lbs.	\$89.99
LED4WWK	2	EPT45	—	2179995	6 lbs.	\$239.99

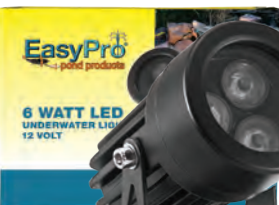

## 6 Watt, Warm White LED Light

- 2800-3000 K warm white LED fixture, rated for 60,000 hour life
- Can be used underwater or in the landscape
- Durable die cast metal housing with removable stand
- 3.5" tall x 2" dia., 3.75" dia. base
- Epoxy filled for extra waterproofing and heat dissipation
- Quick connect ends on 20' power cord
- **Three year warranty**



Removable Stand

**Best Seller!**

Part #	Lights Included	Transformer Included	Case Quantity	Stocking Code	Ship Weight	List Price
LED6WW	1	—	6	492997	2 lbs.	\$123.99

LED6WW lights come with quick connect plug cord ends for easy connection to MT10, MT20 or EPT45 transformers on page 59



## Stainless Steel Landscape and Water Feature Lighting

These fixtures are created with a patent pending design that increases cooling and extends the life of the fixture. All models have 316 stainless steel housing, 30' power cords with bare leads (12v/AC), are retail ready and offer an impressive five year warranty.

### 9 Watt Stainless Steel LED Light

- 2800-3000 K warm white
- 1233 lumens per fixture
- 6" tall x 4 1/4" diameter



**LED9WW**

One warm white LED light

**LED9WWK**

Pack of two warm white LED lights with EPT45 transformer

### 12 Watt Stainless Steel LED Light

- 2800-3000 K warm white
- 1380 lumens per fixture
- 7 1/2" tall x 6 1/4" diameter



### 18 Watt Stainless Steel LED Light

- 2800-3000 K warm white
- 2070 lumens per fixture
- 8 1/4" tall x 7 1/2" diameter



Part #	Description	Fixture Size Ht. x Diameter	Case Quantity	Stocking Code	Ship Weight	List Price
<b>LED9WW</b>	9 watt LED light - single fixture	6" x 4 1/4"	6	6157498	3 lbs.	\$209.99
<b>LED9WWK</b>	9 watt LED light - 2 pack w/ EPT45 transformer	7 1/2" x 6 1/4"	—	7296754	11 lbs.	\$399.79
<b>LED12WW</b>	12 watt LED light - single fixture	7 1/2" x 6 1/4"	6	6172498	4 lbs.	\$229.99
<b>LED18WW</b>	18 watt LED light - single fixture	8 1/4" x 7 1/2"	6	9224992	5 lbs.	\$299.99



## Underwater LED Light Strips

More than just an underwater light! Use with pathways and bridges to accent your pond.

- Ideal for use with Vianti Falls on page 21, waterfall diffusers on page 23 or underwater to light up waterfalls, streams, etc.
- 15' power cord between light and transformer
- Available in 11", 23" or 35" lengths and in warm white or blue
- Use in or out of water (fresh water only)
- Three year warranty

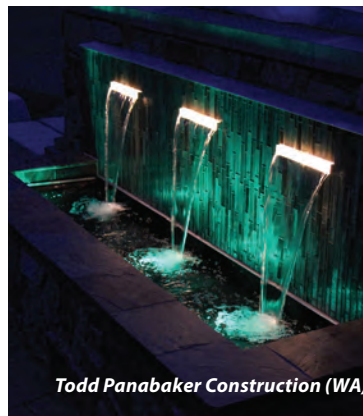

Part #	Description	Max. Watts	Transformer Included	Stocking Code	Ship Weight	List Price
<b>LED11WW</b>	11" LED light strip, warm white	1.75	MT10	374991	3 lbs.	\$99.99
<b>LED11CB</b>	11" LED light strip, blue	1.75	MT10	874992	3 lbs.	\$99.99
<b>LED23WW</b>	23" LED light strip, warm white	3.5	MT10	3127495	4 lbs.	\$169.99
<b>LED23CB</b>	23" LED light strip, blue	3.5	MT10	4127493	4 lbs.	\$169.99
<b>LED35WW</b>	35" LED light strip, warm white	9	MT20	6194998	5 lbs.	\$259.99
<b>LED35CB</b>	35" LED light strip, blue	9	MT20	7194993	5 lbs.	\$259.99





# Color Changing LED Lighting

## *cabrio*™ lighting series



SINCE 1970



**cabrio™ Remote Control**

This remote is required to operate all Cabrio lights on this page.

The Cabrio remote control works with radio frequency (RF) for up to a 60' range.

A single remote can operate multiple Cabrio fixtures in any combination and within range.

Extendible antenna allows for increased range of use.

A23 battery included

Size: 2" x 4" x 3/4"

Part #CLEDRC

**Vivid color for your water features or landscape!**  
**Compact fixture emits powerful light, using only 3 watts**

- Wide spectrum of color options
- Stainless steel housing with removable base
- Epoxy filled. Use in or out of water
- Sync with all your other Cabrio lights using a single remote control.
- 15' power cord with quick connect plugs

**5 Year Warranty!**



### *cabrio*™ Compact Color Changing LED Light

Part #	Description	Max Watts	Stocking Code	Ship Weight	List Price
CLED4SS	Cabrio color changing LED light	3	6104993	2 lbs.	\$139.99
CLEDRC	Cabrio remote control w/ battery	—	819272	1 lb.	\$25.69

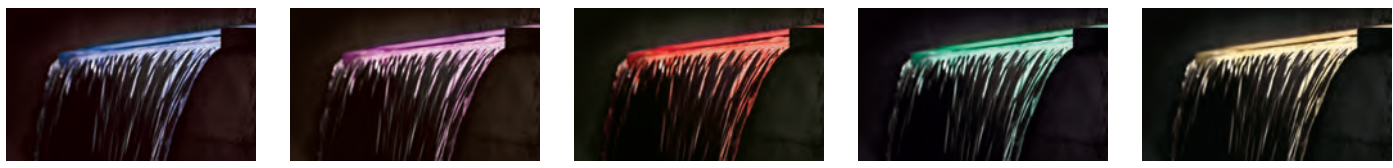

### *cabrio*™ Color Changing LED Light Strips

**Great for waterfalls, spillways, deck steps, railings and more. Compatible with Vianti Falls Spillways.**

- 15' power cord with quick connect plugs

**1 Year Warranty**



Part #	Description	Max Watts	Stocking Code	Ship Weight	List Price
CLED11	Cabrio 11" color changing LED strip	3	389991	2 lbs.	\$119.99
CLED23	Cabrio 23" color changing LED strip	7	5134996	4 lbs.	\$179.99
CLED35	Cabrio 35" color changing LED strip	9	7194992	5 lbs.	\$259.99
CLEDRC	Cabrio remote control w/ battery	—	819272	1 lb.	\$25.69

*Cabrio lighting is not approved for use in swimming pools or spas. Finish on light strips may vary*

## Color Changing Pond & Water Feature Lights

Maximize the impact of your water feature at night! Originally designed for use on floating fountains, these extra bright LED lights are also ideal for creating optimal nighttime displays on a wide variety of water features.

- Stainless steel 17 watt lights have both true warm white diodes and color changing diodes.
- Quick connect plugs on controller, cables and lights for easy assembly
- Stainless steel mounting brackets and hardware
- Weather resistant digital timer/controller with remote control. The remote control works up to 1000' and makes selecting colors and adjusting the brightness easy. RGBC controllers feature built-in memory protection in case of power interruption.
- Multiple controllers can be synced with one remote control.
- Red, green, blue, warm white, lavender, cyan and yellow-green solid colors plus several preprogrammed sequences with additional colors



Tranquil Escapes (SC)

**Custom build these lighting systems by selecting the number of lights needed and the corresponding controller. Then use a 15' or 30' power cable and splitters to complete the layout!**



**Controller**  
RGBC4M  
RGBC6M



**Power Cord**  
LKC5015 / LKC5030



**Splitters**



**Fixtures**  
RGB9PL

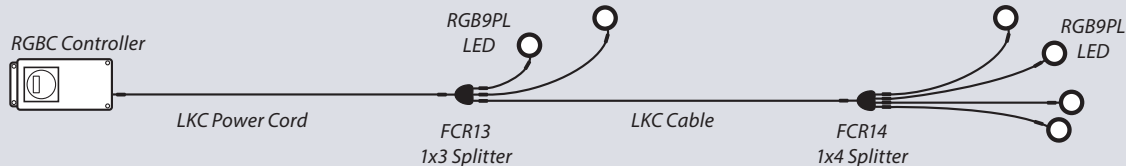

### Light Fixtures

Part #	Description	Stocking Code	Ship Weight	List Price
<b>RGB9PL</b>	RGBW LED stainless steel fixture w/ 2' long pigtail quick connect - 17 watts	7232493	3 lbs.	\$299.99



### Controllers

Part #	Description	Max Lights	Stocking Code	Ship Weight	List Price
<b>RGBC4M</b>	Controller with timer for 5 pin RGBW LED system	4	7201493	8 lbs.	\$259.99
<b>RGBC6M</b>	Controller with timer for 5 pin RGBW LED system	6	2302246	9 lbs.	\$389.99

### Splitters

Part #	Description	In/Out	Stocking Code	Ship Weight	List Price
<b>FCR12</b>	Splitter for 5 pin low voltage RGBW LED system	1x2	537191	1 lb.	\$47.99
<b>FCR13</b>	Splitter for 5 pin low voltage RGBW LED system	1x3	148435	1 lb.	\$62.49
<b>FCR14</b>	Splitter for 5 pin low voltage RGBW LED system	1x4	765873	2 lbs.	\$84.99

### Power Cords

Part #	Description	Cord Length	Stocking Code	Ship Weight	List Price
<b>LKC5015</b>	Power cord for 5 pin RGBW LED systems	15'	549591	3 lbs.	\$63.99
<b>LKC5030</b>	Power cord for 5 pin RGBW LED systems	30'	187575	4 lbs.	\$112.99





## LED Fountain/Statuary Light Set *Tranquil Décor™*

- Removable barbed inlet fitting for use with 3/4" tubing
- 10' power cord between light and transformer, 6' power cord on transformer
- 1 3/8" diameter
- 12 per case
- Cool white light



LED8B



LED8B3



Part #	Description	Stocking Code	Ship Weight	List Price
LED8B	LED Light & Transformer	329996	2 lbs.	\$39.99
LED8B3	3 LED Lights & Transformer	159997	3 lbs.	\$79.99

## Brilliant LED Fountain Ring Lights

IP68 rated stainless steel lights are designed to slide over top of Sch. 40 PVC fountain stand pipes to illuminate formal water features. They can also be used in waterfalls, ponds and in the landscape.

- 15' power cords
- 12v power, use with EasyPro® transformers on page 59
- Adjustable - lights can be mounted at desired height on Sch. 40 PVC stand pipe and secured in place with stainless mounting screws (included)
- 2800-3000 K warm white LED
- **Five year warranty**



BFL18



BFL12



BFL9

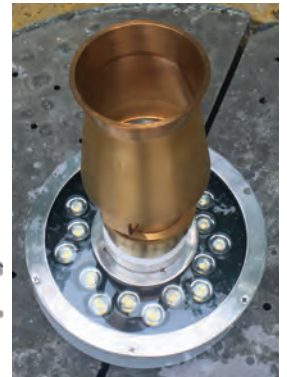

Part #	Description	Fits Sch. 40 PVC Stand Pipe	Light Dimensions	Stocking Code	Ship Weight	List Price
BFL9	9 watt fountain light	1" diameter	6 1/2" dia. x 2 7/8" h	9164999	2 lbs.	\$219.99
BFL12	12 watt fountain light	1 1/2" diameter	7 1/8" dia. x 3 1/8" h	8224992	4 lbs.	\$299.99
BFL18	18 watt fountain light	2" diameter	7 7/8" dia. x 3 1/8" h	6269994	5 lbs.	\$359.99



## Cables/Splitters



LEDEX6



L3WS



L3WP

Part #	Description	Stocking Code	Ship Weight	List Price
LEDEX6	15' extension cable for use with LED lights	318748	1 lb	\$24.99
L3WS	Three way LED splitter - forked connector	711995	1 lb.	\$15.99
L3WP	Three way LED splitter - quick connect plug connector	211173	1 lb.	\$14.89

## Low Voltage Transformers

3 Year limited warranty on all transformers!

### 10 Watt Transformer

- Three outlet strip is ideal for use with LED lights
- Transformer plugs directly into outlet

Use LEDEX6 to extend lengths and add more LED lights



### 20 Watt Transformer

- Six outlet strip makes connecting multiple lights easy!
- Great for use with low wattage LED lights
- Use with outdoor timer



### 45 Watt Transformer with Photo Eye

- Photo eye for automatic on at dusk with four, six or eight hour settings
- Includes screw type connectors for halogen lights and three way splitter for LED lights



Part #	Watts	Power Cord	Size (WxDxH)	Photo Eye Included	Case Quantity	Stocking Code	Ship Weight	List Price
MT10	10w	—	6½" dia. x 2⅞" h	no	6	319194	1 lb.	\$25.59
MT20	20w	2'	7⅞" dia. x 3⅞" h	no	6	639743	2 lbs.	\$52.99
EPT45	45w	6'	7⅞" dia. x 3⅞" h	yes	4	367491	5 lbs.	\$89.99
LEDEX6	15' extension cable for use with LED lights				6	318748	1 lb.	\$24.99
L3WP	Three way LED splitter - quick connect plug connector				—	211173	1 lb.	\$14.89

## 100/150 Watt Transformers with Photo Eye

- Has a photo eye that automatically turns on at dusk and a timer that runs four, six or eight hours before turning lights off
- Epoxy filled and weatherproof for long life
- Capable of 100% loads
- 150w model also available in 230v (EPT1502)



Rick Smith (MI)



Part #	Watts	Power Cord	Size (WxDxH)	Photo Eye Included	Case Quantity	Stocking Code	Ship Weight	List Price
EPT100	100w	17"	4" x 6" x 3½"	yes	4	2101991	8 lbs.	\$135.99
EPT150	150w	17"	4" x 6" x 3½"	yes	4	4104996	9 lbs.	\$139.99
EPT1502	150w	17"	4" x 6" x 3½"	yes	4	4104997	9 lbs.	\$139.99





# DuraLiner™ 45 & 60 Mil EPDM Liner



SINCE 1970

High quality 45 and 60 mil EPDM liner & accessories with the manufacturing capacity 100% focused on the Pond Market - not the roofing market. Manufacturing is done in an ISO9001 certified factory and all ASTM testing is done to ensure equal or superior quality to existing brands.



The trusted choice of professional landscapers, nurseries, koi pond and water garden installers!

- Easy to shape and form! Stays flexible even in extreme temperatures from -40° to 175°F.
- Weather and UV resistant - will not crack with age.
- Puncture resistant
- Fish and plant friendly
- More consistent throughout the roll & width does not contain the imperfections & blisters like other brands
- Available in pre-cut sizes, custom cut for your project, and by the roll for larger ponds
- 20 year limited warranty



## TECHNICAL SPECIFICATIONS

Physical Property	Test Method	Req. of ASTM D 7465 (Type 1)	EasyPro 45 mil DuraLiner™ Values	Req. of ASTM D 7465 (Type 1)	EasyPro 60 mil DuraLiner™ Values
Thickness (mil)	ASTM D-412	<b>45 mil</b>	<b>45 mil</b>	<b>60 mil</b>	<b>60 mil</b>
Tensile Strength (MPa)	ASTM D-412	9 Min	<b>9.1</b>	9 Min	<b>9.5</b>
Elongation Ultimate (%)	ASTM D-412	300% Min	<b>350%</b>	300% Min	<b>360%</b>
Tear Resistance (kN/m)	ASTM D-624	26.27 Min	<b>27</b>	40.28 Min	<b>41.05</b>
Tensile Set (%)	ASTM D-412	10% Max	<b>7%</b>	10% Max	<b>2.15%</b>
Brittleness Point Max °F (°C)	ASTM D-2137	-49°F (-45°C)	<b>No Cracks</b>	-49°F (-45°C)	<b>No Cracks</b>
Heat Aged* Elongation Ultimate (%)	ASTM D-412	200% Min	<b>275%</b>	200% Min	<b>217%</b>
Heat Aged* Tear Resistance (kN/m)	ASTM D-624	21.9 Min	<b>23.90</b>	37.3 Min	<b>38</b>

\*Heat aged test conducted for 670 hours at 240°

## 50' ROLLS



Part #	Rolled Liner Size	Core Length	Stocking Code	Approx. Ship Weight	List Price
<b>45 mil EPDM DuraLiner</b>					
RPL105	10' x 50'	7'	8475009	185 lbs.	\$650.00
RPL155	15' x 50'	7'	9712509	265 lbs.	\$975.00
RPL205	20' x 50'	7'	7950006	350 lbs.	\$1300.00
RPL255	25' x 50'	7'	51187503	430 lbs.	\$1625.00
RPL305	30' x 50'	7'	21425004	510 lbs.	\$1950.00
RPL355	35' x 50'	11'	61662508	600 lbs.	\$2275.00
RPL405	40' x 50'	11'	41900003	685 lbs.	\$2600.00
RPL505	50' x 50'	11'	12375007	850 lbs.	\$3250.00
<b>NEW 60 mil EPDM DuraLiner</b>					
RPL6-305	30' x 50'	7'	81725007	660 lbs.	\$2250.00
RPL6-405	40' x 50'	11'	92300006	860 lbs.	\$3000.00

## 100' ROLLS



Part #	Rolled Liner Size	Core Length	Stocking Code	Approx. Ship Weight	List Price
<b>45 mil EPDM DuraLiner</b>					
RPL051	5' x 100'	7'	9475009	185 lbs.	\$650.00
RPL101	10' x 100'	7'	8950007	350 lbs.	\$1300.00
RPL151	15' x 100'	7'	31425004	510 lbs.	\$1950.00
RPL201	20' x 100'	7'	61900008	675 lbs.	\$2600.00
RPL251	25' x 100'	11'	12375009	850 lbs.	\$3250.00
RPL301	30' x 100'	11'	72850006	1,010 lbs.	\$3900.00
RPL351	35' x 100'	11'	43325007	1,175 lbs.	\$4550.00
RPL401	40' x 100'	11'	93800006	1,335 lbs.	\$5200.00
RPL501	50' x 100'	11'	24750001	1,660 lbs.	\$6500.00
<b>NEW 60 mil EPDM DuraLiner</b>					
RPL6-151	15' x 100'	7'	61725007	660 lbs.	\$2250.00
RPL6-501	50' x 100'	11'	75750004	2070 lbs.	\$7500.00

## CUT TO LENGTH

Part #	Description	Stocking Code	Ship Weight	List Price
RPL45	45 mil EPDM DuraLiner - Specify width and length	2994	—	\$1.30/sq. ft.
RPL60	60 mil EPDM DuraLiner - Specify width and length	41158	—	\$1.50/sq. ft.

# DURALINER™



Part #	Boxed Liner Size	Finished Pond Size	Boxes per Crate	Stocking Code	Approx. Ship Weight	List Price
BPL810	8' x 10'	4' x 6'	60 boxes	679202	29 lbs.	\$104.00
BPL1010	10' x 10'	6' x 6'	45 boxes	199004	35 lbs.	\$130.00
BPL1015	10' x 15'	6' x 11'	24 boxes	8148509	52 lbs.	\$195.00
BPL1515	15' x 15'	11' x 11'	24 boxes	3222756	77 lbs.	\$292.50
BPL1520	15' x 20'	11' x 16'	18 boxes	4297002	102 lbs.	\$390.00
BPL1525	15' x 25'	11' x 21'	18 boxes	8371254	129 lbs.	\$487.50
BPL2020	20' x 20'	16' x 16'	18 boxes	6396002	136 lbs.	\$520.00

Contact us for volume pricing and truckload pricing on DuraLiner!

Volume pricing for 30,000 sq. ft. + orders

Extra savings and free shipping on 120,000 sq. ft. truckloads



## DuraLiner™ Pond Liner Underlayment

- Non-woven geotextile fabric in two widths - 5' and 10' – easy to match up to the EPDM liner
- Provides additional tear and puncture protection from roots, stones or any other sharp objects
- Can be used on top of liner as well to protect from punctures when adding gravel
- Provides enhanced soil stability and erosion control

Now you can order 10' wide product on a 5' wide core!  
Contact us for volume pricing on ten rolls or more

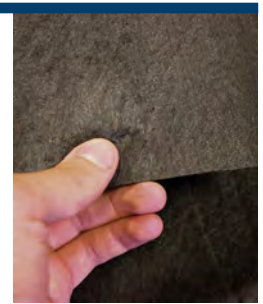

RP33 / RP36

Part #	Description	Stocking Code	Ship Weight	List Price
<b>4 oz. DuraLiner Underlayment</b>				
FPU	4 oz. 5' or 10' wide x any length	1203	—	\$0.32/sq. ft.
PLU5360	4 oz. 5' wide x 360' roll	6221597	65 lbs.	\$276.99 roll
PLU10360	4 oz. 10' wide x 360' roll	7443185	125 lbs.	\$553.98 roll

### NEW 10 oz. DuraLiner Underlayment

FPU10	10 oz. 5' or 10' wide x any length	2447	—	\$0.70/sq. ft.
PLU10-5360	10 oz. 5' wide x 360' roll	3487998	130 lbs.	\$609.99 roll
PLU10-10360	10 oz. 10' wide x 360' roll - 10 foot core	8975986	255 lbs.	\$1219.98 roll
PLU10-10360X5	10 oz. 10' wide x 360' roll - 5 foot core	41063987	255 lbs.	\$1329.98 roll

### NEW 15 oz. DuraLiner Rock Pads

RP33	15 oz. 3' x 3'	715994	1 lb.	\$19.99
RP36	15 oz. 3' x 6'	826395	2 lbs.	\$32.99



## 8" Diameter Liner Patch

- 8" diameter circular patch with adhesive backing
- Use for quick repair of small cuts and punctures
- Sold individually
- 100 per case



Part #	Stocking Code	Ship Weight	List Price
DLP8	67492	1 lb.	\$9.99

## 3" Liner Seam Kit

- Contains three 2 oz. bottles of primer, 25' roll double sided 3" tape, seam roller, scrubber pads and latex gloves
- 2 oz. bottle of primer sold separately for small repairs, part #DLAP2



Part #	Stocking Code	Ship Weight	List Price
LSK	656242	5 lbs.	\$74.99
DLAP2	611243	1 lb.	\$14.99

## Pond Patch Kit

Includes:

- Two 6" x 6" patches
- One 2 ounce bottle of primer
- Roller
- Scrubber pad
- Disposable gloves



Part #	Stocking Code	Ship Weight	List Price
LPK	828121	2 lbs.	\$37.49

More DuraLiner accessories on page 62



# EPDM Liner Accessories



SINCE 1970

## EPDM Tapes

DuraLiner™ offers both a 3" double sided seaming tape as well as 6" single sided cover tape. Both can be used to seam two panels of EPDM material together. ALWAYS use DuraLiner™ Primer to clean and prep the material. Primer helps tapes adhere much better. Use a seam roller after tapes are applied to work out air bubbles and ensure a watertight seam.

10%  
CASE DISCOUNT

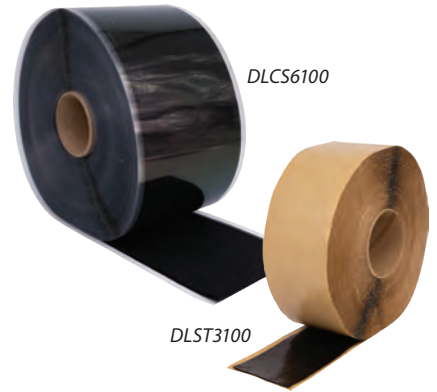

Part #	Description	Case Qty.	Stocking Code	Ship Weight	List Price
DLST325	DuraLiner Seam Tape - 3" x 25'	12	833742	2 lbs.	\$44.99
DLST3100	DuraLiner Seam Tape - 3" x 100'	4	797494	7 lbs.	\$129.99
DLCS625	DuraLiner Cover Tape - 6" x 25'	4	189993	6 lbs.	\$119.99
DLCS6100	DuraLiner Cover Tape - 6" x 100'	2	5284996	23 lbs.	\$379.99

## EPDM Primers

EPDM liner panels must be clean and dry for proper tape adhesion. Always use DuraLiner™ EPDM Primer to clean the material before applying tape.

- Use scrubber pads (below) to apply the primer. Let dry to the touch (flash off) before applying tape.
- Certain states require LVOC primer be used. Normal primer may not be sold or shipped into these states. (See below for list)
- Coverage - approx 100' of seaming per gallon

10%  
CASE DISCOUNT



Part #	Description	Case Qty.	Stocking Code	Ship Weight	List Price
DEP32*	DuraLiner EPDM Primer - 1 qt.	12	243493	3 lbs.	\$57.99
DEP128*†	DuraLiner EPDM Primer - 1 gal.	6	889994	10 lbs.	\$119.99
DEP32LV	DuraLiner LVOC EPDM Primer - 1 qt.	12	653993	3 lbs.	\$71.99
DEP128LV †	DuraLiner LVOC EPDM Primer - 1 gal.	6	3109497	10 lbs.	\$145.99

\* LVOC primer required in these states: CA, CT, DC, DE, MA, MD, ME, NH, NJ, NY, PA, RI, VT  
† One gallon primers must ship as hazardous material with additional charges via UPS or motor freight.

## Liner Scrubber Pads

- These pads are used to apply seam primer, clean and prepare the seam area prior to installing tape or tape accessories
- Includes five pads



## Seam Roller

- Perfect for applying heavy pressure to the seam to properly fuse tape to liner
- Available in contractor grade with a wood/metal handle
- DLSR roller is made from silicone and will not stick to tape or liner



## Water Seal

- Creates a flexible, water-tight seal between liner and substrate behind liner.
- Approx. 10 lineal foot @ 3/8" bead coverage



## Pipe Boot

- Can be cut to fit pipes from 1" to 6 7/8" O.D.
- Taped flange bonds to liner and stainless clamp to tighten around pipe



## 10' Aluminum Termination Bar

- Pre-punched in 4" increments
- Use every hole when terminating underwater, every other hole above water
- Can be cut in half to ship small parcel or must ship via freight in full 10' lengths

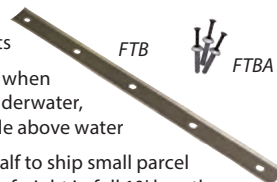

## Edge Sealant

- Used along the outer edge of a seam to prevent water from getting in between liner panels.
- Approx. 20 lineal foot @ 1/4" bead coverage



Part #	Description	Stocking Code	Ship Weight	List Price
DL69P	Liner scrub pads (5 pads)	22992	2 lbs.	\$3.99
DLPB	Pipe boot	463743	2 lbs.	\$84.99
DLSR	Seam roller, plastic handle	26713	2 lbs.	\$11.19

Part #	Description	Stocking Code	Ship Weight	List Price
FTB	10' termination bar	629994	2 lbs.	\$39.99
FTBA	Concrete anchors, 1 1/4"	81762	—	\$2.35
DLWS10	Water sealant, 10 oz. tube	912748	1 lb.	\$16.99
DLES11	Edge sealant, 11 oz. tube	214997	1 lb.	\$19.99



800-448-3873



# EasyWeave Liner



Mid Michigan Ponds (MI)



Greenline, Inc. (MI)

## EasyWeave Reinforced Woven Polyethylene Pond Liners

Ideal for lining large ponds — up to 75,000 square feet in one piece and custom made to your pond size

These EasyWeave polyethylene liners are engineered to offer great strength in a light weight liner material. The material is UV stabilized to offer years of worry free protection against the damaging rays of the sun. Unlike regular multi-layered liners which simply stack the layers of liner on top of each other, these liners are woven together — this gives the ultimate in strength. Because of the light weight and strength, these liners can be manufactured in sizes up to 75,000 square feet.

### Features

- Designed for easy installation and long life span
- Puncture, abrasion and chemically resistant construction
- High strength HDPE woven core that provides superior dimensional stability
- Outstanding UV, ozone and oxidation resistance
- Unlike standard PVC liners, which need 12" of soil over the entire liner, these liners do not require coverage other than around the edges — this lowers the overall installation cost dramatically!
- Custom made liners require approximately 10-14 days for manufacturing and delivery



**20 year warranty when under water, 10 year warranty when exposed to direct sunlight**

**Pipe boots are available for sealing around incoming lines below water, contact us for details**

### Liner Panel Size Parameters

Width: 12' width increment standard, 6' increment width available for additional \$150.00 • Length: Any desired length in 1' increments up to 300' long

See our website for video installations of liner,



spec sheets, training and design tips

### Applications

- Aquaculture
- Pond liner
- Soil remediation
- Exposed applications
- Oil and gas
- Irrigation reservoirs and canals
- Water management
- Hydroponic farming
- Fracking

Part #	Thickness	Maximum Panel Size**	Maximum Pallet Size Liner	Square Fee Quantity	Stocking Code	Ship Weight per 1000 sq. ft.	List Price per sq. ft.
WCP24	24 mil	75,000	18,000'	1000' - 10000'	2377	80 lbs.	\$0.59
				10001' - 20000'	9354	80 lbs.	\$0.56
				20000' - 40000'	6328	80 lbs.	\$0.53
				40000'+	—	—	Call
WCP30	30 mil	65,000	16,000'	1000' - 10000'	9446	93 lbs.	\$0.61
				10001' - 20000'	5422	93 lbs.	\$0.58
				20000' - 40000'	1387	93 lbs.	\$0.55
				40000'+	—	—	Call

\*\*Liners over 16,000 sq. ft. come as large roll and ship on flat bed truck



Outside Inc. (MI)



# Underliner Vent & Liner Air Vent



SINCE 1970



## Pond Shield®

Ideal for sealing concrete ponds, pools and fountains

This non-toxic two-part epoxy sealer is designed specifically for sealing concrete, steel, wood, fiberglass, etc. With Pond Shield you get all the water proofing of a liner without the wrinkles.

- Easy To Apply — No special equipment needed, just brush or roll on
- Flexible — remains flexible from -78° to 140°F
- Durable — Bonds to substrate rather than covering it, leading to longer life and less repairs/maintenance
- Beautiful — Provides a smooth, hard finish with no wrinkles or folds — Makes surface easier to clean
- 1.5 quart kits are easy to ship. Can be special ordered in larger containers but due to hardening time smaller 1.5 quart batches are recommended

Each kit covers approximately 60 square feet of surface area!

**Stocked in black. All other colors drop ship with a 2 kit minimum.**

Available in seven colors!

Part #	Description	Minimum Quantity	Stocking Code	Ship Weight	List Price
PAQB	Black Pond Shield Kit	In stock - no minimum	374621	6 lbs.	\$99.49
PAQC	Clear Pond Shield Kit	Factory direct - 2 kit minimum	274624	6 lbs.	\$99.49
PAQG	Gray Pond Shield Kit	Factory direct - 2 kit minimum	874627	6 lbs.	\$99.49
PAQCBL	Competition Blue Pond Shield Kit	Factory direct - 2 kit minimum	574626	6 lbs.	\$99.49
PAQDBL	Delta Blue Pond Shield Kit	Factory direct - 2 kit minimum	874627	6 lbs.	\$99.49
PAQW	White Pond Shield Kit	Factory direct - 2 kit minimum	974621	6 lbs.	\$99.49
PAQFG	Forest Green Pond Shield Kit	Factory direct - 2 kit minimum	274623	6 lbs.	\$99.49



- BLACK
- CLEAR
- GRAY
- COMPETITION BLUE
- DELTA BLUE
- WHITE
- FOREST GREEN

Actual colors may vary from swatches shown here.

## Underliner Vent System

Helps to prevent uplifting or floating of pond liners caused by methane gases in organic soils or high water tables

- Provides a strong, secure channel for ground water and gases to freely flow through to designated exits (GE4EO end outlets)
- Prefabricated 6" strip consisting of a molded grid wrapped in geotextile fabric to permit a high flow of water into the molded grid while restraining soil particles
- Easy to install — no heavy equipment or skilled labor needed — Simply roll out in the deepest portion of your pond
- Comes in 150' long rolls, is 6" wide and 1" tall

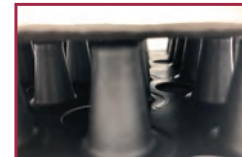

**Ships from our warehouse — no minimum order!**

Part #	Description	Stocking Code	Ship Weight	List Price
GE6150	Underliner Vent - 6"x150' roll	4338249	24 lbs.	\$409.99
GE4EO	4" End outlet	324258	3 lbs.	\$29.39



## Liner Air Vent

- Use these 1 1/2" vents to release air or water trapped under pond liners
- Includes 1 1/2" bulkhead fitting and pressure relief fitting
- Helps prevent liner from floating up when air (or water) gets trapped underneath



Part #	Description	Stocking Code	Ship Weight	List Price
LAV	Liner air vent	144997	1 lb.	\$59.99



ONE STEP NON STOP

## Power-Cyclone Vacuum by Matala

## Matala® Pond Vacuums *While Supplies Last!*

Matala offers three different sizes of pond vacuums to aid in pond cleaning and maintenance

The **MPVC** is a contractor/pond maintenance model that features a dual pump system where water is continuously sucked through the system and pumped back out of the tank allowing for much faster, consistent cleaning action.

- Easy operation with heavy duty wheels and handle
- Internal pre-filter bag
- 1500 gallon per hour vacuum/exhaust capacity
- Suction lift 5' above water
- Includes vacuum, extension tubes, nozzles, 32' discharge hose, 26' suction hose, sludge collection bag, power cord and assembly hardware

The **MPV2** and **MPVPRO** are designed for homeowner use and are designed to suck until the tank is full then automatically shut off, allowing the tank to drain before starting up again.

- Includes vacuum, five extension tubes, four nozzles, 8' discharge hose, 16' suction hose, sludge collection bag, 16' power cord and assembly hardware



Part #	Description	Watts	Capacity	Drain Cycle	Stocking Code	Ship Weight	List Price
<b>MPV2</b>	Pond Vacuum II - The Muck Buster	1400	5.3 gallons	25-30 seconds	3217497	27 lbs.	\$299.99
<b>MPVPRO</b>	Pond Vacuum Pro	1400	9.5 gallons	40-45 seconds	9384248	34 lbs.	\$529.99
<b>MPVC</b>	Power-Cyclone Pond Vacuum	2000	13.2 gallons	Continuous	2639995	71 lbs.	\$799.99
<b>GSH8</b>	Gravel head attachment for all models above		-	-	250741	4 lbs.	\$69.99

*Inquire for pallet pricing specials!*



## Thermo-Pond Heater/De-icers

Pond de-icers are used to keep a small hole open in the ice during freezing conditions. This small hole allows potentially harmful gas to escape from the pond water. The gas is caused by decomposing leaves, dead algae, fish waste, etc. and will become lethal if levels become too high. Maintaining a small opening vents the gas.

**TP100** - Energy efficient de-icer uses only 100 watts of power

- Tested in Northern Wisconsin ponds down to -39°F
- Completely enclosed in plastic — no danger of heating element damaging liner
- This de-icer costs a little more than other de-icers, but the electrical savings will pay for itself in the first month
- One year warranty

**TPH250, TPH750, TPH1500** - Perfect climate deluxe pond de-icers

- Can be used as a surface de-icer or converts in seconds to a bottom heater
- Two year warranty
- Thermostatically controlled — operates only when needed, saving electricity



TP100



TPH250



Part #	Description	Power Cord	Case Qty	Stocking Code	Ship Weight	List Price
<b>TP100</b>	100 watt	12'	6	358492	3 lbs.	\$77.99
<b>TPH250</b>	250 watt	12'	6	850247	3 lbs.	\$66.99
<b>TPH750</b>	750 watt	12'	6	655492	3 lbs.	\$73.99
<b>TPH1500</b>	1500 watt	12'	6	159998	4 lbs.	\$79.99





## Premium Pond Cover Netting

Strong black netting is protected with a UV coating to last for years!

- Currently most other manufacturers offer a small variety of prepackaged netting that does not fit the needs of many pond or stream applications. EasyPro® Premium Pond Cover Netting is available in 10', 20' and 30' wide rolls each 100' long
- You simply pull out the length needed, cut it and BINGO — you have a cover net exactly the length you need!
- Selling EasyPro® netting allows you to cut your inventory down to only three SKUs and greatly increases your selling choices
- By stocking pond cover netting like you would stock liner, inventory is minimized but size choices are increased
- A variety of prepackaged sizes are also available
- Custom cut pieces are available, allowing you to buy just what you need, please specify length when ordering, 10', 20' or 30' wide



Pre-cut Sizes



Bulk Netting



Part #	Description	Case Quantity	Stocking Code	Ship Weight	List Price
--------	-------------	---------------	---------------	-------------	------------

### Pre-cut Netting

NP1515	Premium - 3/4", 15' x 15', w/8 stakes	12	218744	2 lbs.*	\$24.99
NP2020	Premium - 3/4", 20' x 20', w/8 stakes	12	637498	3 lbs.*	\$49.99
NP2030	Premium - 3/4", 20' x 30', w/10 stakes	8	349495	5 lbs.*	\$65.99
NP3030	Premium - 3/4", 30' x 30', w/12 stakes	8	764492	7 lbs.*	\$85.99
NRS12	12 pack netting stakes	—	69678	1 lb.	\$12.89

Pond cover netting in bulk. Available in 10', 20' and 30' widths — cut to length for a perfect fit. Bulk rolls come packaged in a box for easy display on store shelves, simply pull out desired length and cut!

### Bulk Netting

NR101	Premium - 3/4", boxed 10' x 100'	—	280996	6 lbs.*	\$107.99
NR201	Premium - 3/4", boxed 20' x 100'	—	7164998	10 lbs.*	\$219.99
NR301	Premium - 3/4", boxed 30' x 100'	—	3239994	14 lbs.*	\$319.99
NR101F	Premium - 3/8" fine mesh 10' x 100'	—	5164998	10 lbs.*	\$219.99
NR201F	Premium - 3/8" fine mesh 20' x 100'	—	7322497	13 lbs.*	\$429.99
CNR34	Premium - 3/4" cut to length 10', 20' or 30' wide	—	30124	—	\$0.25 per sq. ft.
CNR38	Premium - 3/8" cut to length 10' or 20' wide	—	40173	—	\$0.32 per sq. ft.

\*Dimensional shipping rate applies







SINCE 1970

# Pond & Garden Tents

## Often imitated, NEVER duplicated!

Don't be fooled by copycats. EasyPro's Deluxe Pond and Garden Tents are the **STRONGEST, MOST DURABLE** pond tents on the market.

### EasyPro® Deluxe Pond and Garden Tents

Stronger netting. Stronger poles.  
Stronger Stakes. Access Zipper.



- **Larger Sizes Available:** 8' x 10', 10' x 14' and 13' x 17'
- **Durability:** Full 12' wide band around the bottom with the tie down loops for extra strength and durability
- **Easy Pond Access:** The built-in zipper allows for easy access to feed your fish
- **Easy-to-Assemble:** Simple two person assembly can be completed and installed over pond in just a few minutes

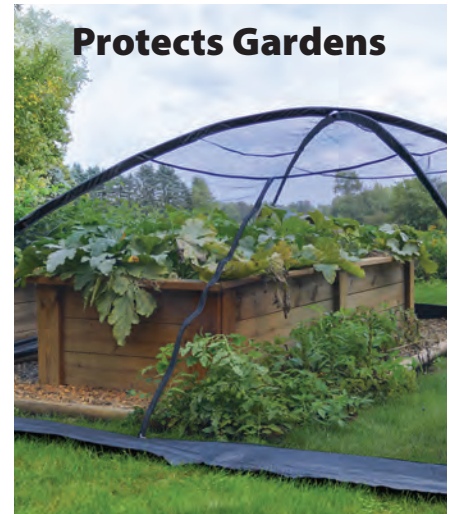
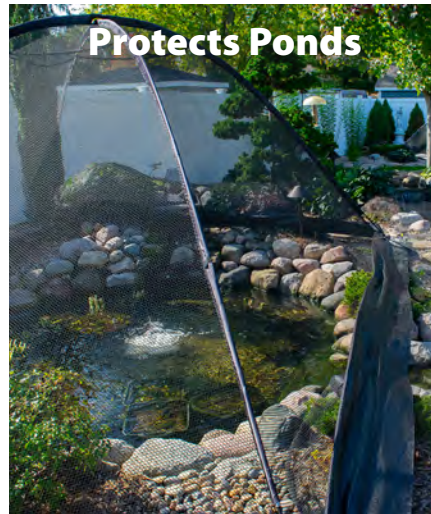

### The reviews are in. EasyPro® is the customer's favorite!

#### EasyPro® Pond Tent Customer Review

"Great investment. We have now gone through three months of leaves falling over this pond net and it works like a charm. This is our third try at a pond net and we are so happy we finally found the EasyPro after dealing with the others that were less well made. It is perfect, sturdy, easy to put together with two people and we have absolutely no leaves in the pond."

#### Competitor's Pond Tent Customer Review

"The assembly was a pain with the poles popping apart and flopping all over. ...after a couple rainy and windy days it collapsed on one side and would (not) stay upright anymore, a couple days later the rest collapsed dropping the net into the water. ...nothing holds the poles in orientation... The stakes hold the corners, but the poles just swivel to be parallel to the ground without moving the stakes."

#### TENT STAKES

EasyPro® provides 12 durable, heavy anchor stakes for securing tent to the ground.

Competitor provides 8 thin metal stakes that can bend and not remain secure in the ground.

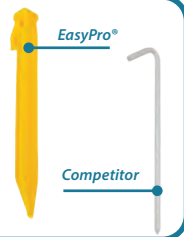

#### NYLON MESH

EasyPro's nylon mesh is UV coated and is secured to frame with full length sleeves, making it last longer and more durable. It's 3/8" mesh is designed to keep out more debris.

Competitor's nylon mesh is NOT UV coated leading to premature failure.

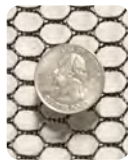

#### TENT POLES

EasyPro's aluminum/fiberglass poles are larger in diameter (11.2mm), stronger and sturdier.

Competitor's 9mm fiberglass only poles are thinner, weaker and have no "inner thread" making assembly difficult.

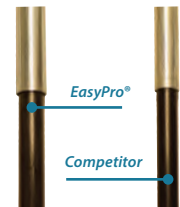

Part #	Description	Stocking Code	Ship Weight	List Price
PCT810	Pond Cover Tent, 8' x 10' with 12 anchors	2104998	10 lbs.	\$139.99
PCT1014	Pond Cover Tent, 10' x 14' with 12 anchors	5134991	13 lbs.	\$179.99
PCT1317	Pond Cover Tent, 13' x 17' with 12 anchors	6187497	18 lbs.	\$249.99



#### Replacement Parts

PCT810P	Collapsible pole (1) for PCT810, 8' x 10' pond tent	927743	3 lbs.	\$36.99
PCT1014P	Collapsible pole (1) for PCT1014, 10' x 14' pond tent	137494	3 lbs.	\$49.99
PCT1317P	Collapsible pole (1) for PCT1317, 13' x 17' pond tent	259999	4 lbs.	\$79.99
PCTS	Replacement stakes, pack of 4	87495	1 lb.	\$9.99



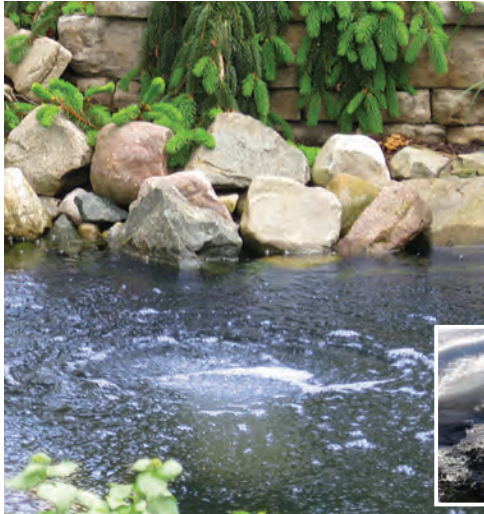

## CAS Compact Aeration Series

## Ornamental Pond Aerators & De-icers

Supplying adequate oxygen levels and circulation during hot summer months or de-icing during freezing months is critical for pond and fish care. CAS Pond Aeration Kits provide quiet and energy-efficient aeration for aquariums, water gardens and koi ponds, making them the perfect choice!



**CAS1**

- Continuous duty compressor with 6' power cord
- Includes 25' of vinyl tubing, air diffuser and check valve
- 2.7 watt compressor will operate up to 4' deep



**CAS2**

- Continuous duty compressor with adjustable air flow, 6' power cord and dual air outlets
- Includes two 25' rolls of vinyl tubing, two air diffusers and two check valves
- 4 watt compressor will operate up to 4' deep



**CAS4**

- Continuous duty compressor with adjustable air flow, 6' power cord and four air outlets
- Includes four 25' rolls of vinyl tubing, four air diffusers and four check valves
- 8.2 watt compressor will operate up to 4' deep



Part #	Description	Approx. Pond Size	Limited Warranty	Stocking Code	Ship Weight	List Price
CAS1	Aeration kit, single diffuser	Up to 1000 gallons	2 years	642744	3 lbs.	\$56.99
CAS2	Aeration kit, dual diffusers	Up to 2000 gallons	2 years	357748	4 lbs.	\$76.99
CAS4	Aeration kit, quad diffusers	Up to 3500 gallons	2 years	993742	7 lbs.	\$124.99

\*Fish load, filtration capacity and other factors affect actual maximum pond size

Compressors require proper enclosure if used outdoors, see page 74

### Individual Compressors

Part #	Fits Kit	cfm	Air Outlets	Watts	Max. Depth	Power Cord	Stocking Code	Ship Weight	List Price
CMC3	CAS1	.14	1	2.7	4'	6'	629997	2 lbs.	\$39.99
CMC5	CAS2	.30	2	4	4'	6'	244998	3 lbs.	\$59.99
CMC8	CAS4	.60	4	8.2	4'	6'	967491	4 lbs.	\$89.99
CASR	Replacement tubing- 25' roll	—	—	—	—	—	49742	1 lb.	\$12.99
CRAS1	Replacement airstone	—	—	—	—	—	86743	1 lb.	\$8.99
CASCV	Replacement check valve	—	—	—	—	—	53741	1 lb.	\$4.99



### Replacement Diaphragm Kits

Part #	Fits Kit	Fits Compressor	Air Outlets	Stocking Code	Ship Weight	List Price
CMC3RK	CAS1	CMC3	1	611242	1 lb.	\$14.99
CMC5RK	CAS2	CMC5	2	217998	1 lb.	\$23.99
CMC8RK	CAS4	CMC8	4	729991	2 lbs.	\$39.99

## Need some Koi Loving Care?

Our best selling koi pond aeration for good reason - these kits are reliable, effective and affordable.

- Ensure adequate oxygen and circulation during hot summer months
- De-icing capability during freezing months
- Kits available for water gardens and koi ponds up to 30,000 gallons
- Quiet and energy efficient
- All kits include compressor with 6' power cord, rubber membrane diffuser(s), connectors and 3/8" QuickSink tubing

**3 Year Warranty**



### LA1

**KLC25 Compressor**  
23 watt / 1.3 cfm

Estimated operating cost: \$1.51/mo.\*



### LA2

**KLC40 Compressor**  
36 watt / 2.1 cfm

Estimated operating cost: \$2.37/mo.\*



### LA3

**KLC60 Compressor**  
60 watt / 3.1 cfm

Estimated operating cost: \$3.94/mo.\*



### LA4

**KLC80 Compressor**  
70 watt / 3.7 cfm

Estimated operating cost: \$4.60/mo.\*

Part #	Compressor Part Number	Watts	3/8" Tubing	Air Diffusers Output	Aerates Ponds Up To**	Max. Depth Recommended	Stocking Code	Ship Weight	List Price
LA1	KLC25	23	25'	1	1000-7500 gallons	6'	3212248	15 lbs.	\$282.99
LA2	KLC40	36	50'	2	2000-15000 gallons	6'	7307493	29 lbs.	\$409.99
LA3	KLC60	60	75'	3	3000-22500 gallons	7'	6363748	37 lbs.	\$484.99
LA4	KLC80	70	100'	4	4000-30000 gallons	8'	8446994	45 lbs.	\$595.99



See page 71 for more information on compressors

\*\*Based on 24/7 operation at \$.09 per kWh. Actual cost will vary with operating conditions.

\*\*Fish load, filtration capacity and other factors affect actual maximum pond size.

## Deluxe Linear Aeration Kits

**3 Year Warranty**

- Extra Quiet — you can barely hear them from only 5' away
- Energy Efficient — operates for only pennies per day
- Very Reliable — motors can often run continuously for up to 8 years
- Oil-less Design — provides clean, dry air with minimal maintenance
- UL Listed — for outdoor use
- Each kit includes compressor, 15' of weighted airline and air diffuser

### LA5W

Includes ML28 compressor, 15' of 3/8" QuickSink weighted tubing and RAD6 air diffuser

### LA10W

Includes ML45 compressor, 15' of 1/2" QuickSink weighted tubing and RAD12 air diffuser



### LA15W

Includes ML80 compressor, 15' of 1/2" QuickSink weighted tubing and two RAD1250 air diffusers connected together



Part #	Compressor Part Number	cfm Air Output	Aerates Ponds Up to	Electrical Usage	Warranty	Stocking Code	Ship Weight	List Price
LA5W	ML28	1.0	25'	25 watts	3 years	3235951	13 lbs.	\$314.09
LA10W	ML45	1.6	50'	45 watts	3 years	7288798	18 lbs.	\$383.89
LA15W	ML80	2.8	75'	80 watts	3 years	4396482	24 lbs.	\$526.69



See page 72 for more information on compressors



## Finally the Perfect Fountain for Small Ponds!



### STARBURST MINI FLOATING POND FOUNTAIN

Designed for ponds as small as 15' in diameter and features built-in, super bright lights and super easy installation.

- Powered by an energy-efficient asynchronous mag drive pump
- Six super bright, cool white LED lights embedded in float
- Spray pattern: 2.5' tall x 6' diameter
- Float diameter: 15"
- Minimum required pond depth: 18"
- Wattage: Fountain 110 watts, Lights 5 watts
- 30' Cord
- One year limited warranty



**BEAUTIFUL** BY DAY  
**STUNNING** BY NIGHT

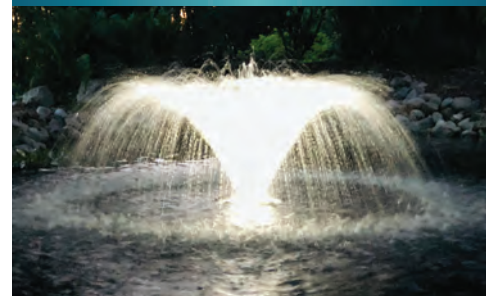

**2.5' tall x 6' diameter**  
Recommended for ponds larger than 15' in diameter

Part #	Description	Stocking Code	Ship Weight	List Price
MWF36	Starburst Mini Fountain	4412497	13 lbs.	\$549.99



## PRO-CLEAR-AIRE Aeration Compressors™

Improve water quality with the benefits of aeration! These compressors are designed for the demanding job of 24 hour operation.

- Quiet, energy-efficient operation
- Dual linear diaphragm design for maximum air flow
- Few moving parts - simple routine maintenance
- Oil-less design makes them ideal for pond aeration.
- Aluminum housing dissipates heat for longer product life
- No electricity in the water - safe for fish, pets and family
- Six foot power cord - 115 volt
- One year warranty



**KPA25, KPA40**  
Dual Use Outlet  
Use with included 3/8" brass barbed connector & clamp or 1/4" female pipe thread connection

**KPA60, KPA80**  
3/4" Outlet  
Use with 3/4" or larger tubing & clamp  
3/4" tubing connector and 2 clamps included

**PRO-TIP** Compressors used outdoors can be easily concealed and protected with Mock Rock™ Landscape Boulders found on page 74.

Part #	Pond Size* (Gallons)	Max. Depth	Max. Watts	cfm Air Flow @ Water Depth of:						Stocking Code	Ship Weight	List Price
				0'	2'	4'	6'	8'	10'			
KPA25	1,000-7,500	5'	25	1.1	0.95	0.75	0.56	0.24	—	2116247	8 lbs.	\$154.99
KPA40	2,000-15,000	7'	30	1.4	1.3	1.1	0.92	0.56	0.25	3134991	8 lbs.	\$179.99
KPA60	3,000-22,500	7'	40	2.1	1.8	1.5	1.3	0.7	0.2	8217493	16 lbs.	\$289.99
KPA80	4,000-30,000	8'	50	2.8	2.5	2.2	2.0	1.4	0.6	1247494	16 lbs.	\$329.99

Recommended operation in shaded area. Operation at deeper than recommended depths will require more frequent diaphragm replacement.  
\*Fish load, filtration capacity and other factors affect actual max. pond size.



## STRATUS KLC™ SERIES

## Linear Diaphragm Air Compressors

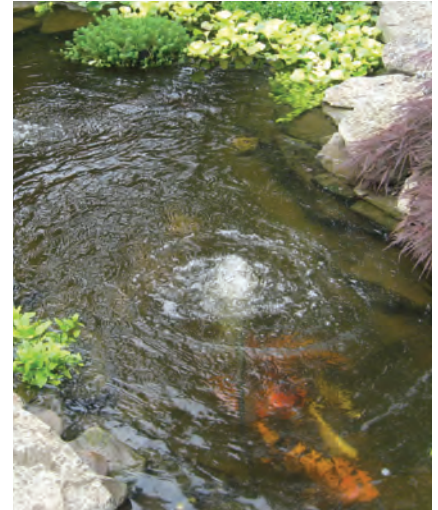

KLC25



KLC40, KLC60 & KLC80



KLC100 & KLC120

These compressors combine outstanding performance with great value!

- Ultra quiet operation with very low energy usage
- Long life, even in continuous applications with minimal maintenance
- Operation at deeper than recommended depths will require more frequent replacement of diaphragms
- Replacement parts below

**3 Year Warranty**

Part #	Watts	Compressor Outlet Size (Nominal)	cfm Air Flow @ Water Depth of:								Stocking Code	Ship Weight	List Price
			0'	2'	4'	6'	8'	10'	12'	14'			
KLC25	23	5/8"	1.3	1	0.8	0.6	0.4	0.1	—	—	6172497	7 lbs.	\$229.99
KLC40	36	5/8"	2.1	1.9	1.6	1.3	0.4	0.6	0.2	—	6221245	13 lbs.	\$294.99
KLC60	60	5/8"	3.1	2.8	2.4	2.0	1.6	1.2	0.7	0.3	9258741	15 lbs.	\$344.99
KLC80	70	5/8"	3.7	3.4	3.1	2.8	2.4	2.0	1.5	0.9	8311247	15 lbs.	\$414.99
KLC100	112	5/8"	4.2	4.1	4.0	3.6	3.1	2.5	2.0	1.2	7424496	21 lbs.	\$565.99
KLC120	130	1"	4.9	4.8	4.6	4.3	4.0	3.5	3.0	2.9	6484492	21 lbs.	\$645.99

Recommended operation in shaded area

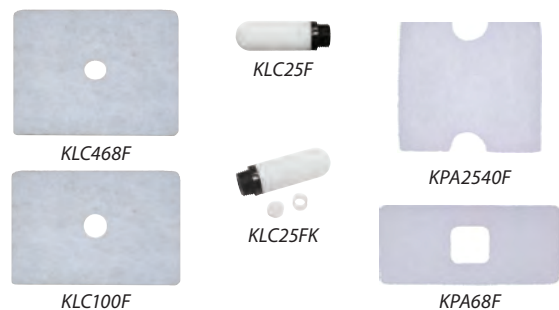

### Diaphragm Kits for KLC Compressors

Part #	Fits	Stocking Code	List Price
KLC25DK	KLC25	629998	\$39.99
KLC40DK	KLC40	735997	\$47.99
KLC68DK	KLC60, KLC80	649121	\$65.49
KLC100DK	KLC100, KLC120	273421	\$97.89



### Filters for KLC Compressors

Part #	Fits	Stocking Code	List Price
KLC25F	KLC25	95474	\$7.29
KLC25FK	KLC25 (3 pc. Filter Set)	85473	\$7.29
KLC468F	KLC40, KLC60, KLC80	64421	\$5.89
KLC100F	KLC100, KLC120	75473	\$7.29

### Diaphragm Kits for KPA Pro-Clear Aire™ Compressors

Part #	Fits	Stocking Code	List Price
KPA2540DK	KPA25, KPA40	211247	\$14.99
KPA68DK	KPA60, KPA80	213491	\$17.99

### Filters for KPA Pro-Clear Aire™ Compressors

Part #	Fits	Stocking Code	List Price
KPA2540F	KPA25, KPA40	21497	\$1.99
KPA68F	KPA60, KPA80	41493	\$1.99



## Linear Piston Compressors

Quiet, energy efficient, weather resistant and durable

- These compressors utilize a small piston instead of a diaphragm to pump air
- It is not at all uncommon for these compressors to operate continuously for up to 8 years
- 3 year warranty when purchased through EasyPro®
- UL listed for outdoor use
- 5' power cord with 115 volt plug included
- A rubber elbow is included for outlet connection
- Repair kits available

**3 Year Warranty!**  
**EasyPro® Exclusive!**



Part #	Watts	Compressor Outlet Size	cfm Air Flow @ Water Depth of:					Max. Depth	Max. psi	Stocking Code	Ship Weight	List Price
			0'	2'	4'	6'	8'					
<b>ML28</b>	26	5/8"	1.3	1.2	0.8	0.5	—	6'	2.6	6240243	8 lbs.	\$309.99
<b>ML45</b>	45	3/4"	1.8	1.7	1.5	1.1	—	6'	2.6	6281327	8 lbs.	\$362.99
<b>ML60</b>	60	3/4"	2.5	2.5	2.3	1.4	0.5	8'	3.5	6364242	13 lbs.	\$469.99
<b>ML80</b>	86	3/4"	3.0	2.9	2.8	2.1	1.2	8'	3.5	2379744	14 lbs.	\$489.99
<b>ML100</b>	95	1"	4.6	4.5	4.2	3.7	1.8	9'	4.0	4565748	22 lbs.	\$729.99
<b>ML120</b>	118	1"	5.2	5.1	4.8	4.5	2.6	9'	4.0	6581247	22 lbs.	\$749.99
<b>ML200</b>	215	1"	9.9	9.1	8.4	7.3	6.0	10'	4.4	7929992	28 lbs.	\$1199.99

*Recommended operation in shaded area*

## ML Compressor Repair Kits

Part #	Compatible With	Stocking Code	List Price
<b>ML28RK</b>	ML28	955712	\$71.89
<b>ML45RK</b>	ML45	767186	\$86.69
<b>ML60RK</b>	ML60	8112061	\$144.59
<b>ML80RK</b>	ML80	4122918	\$158.59
<b>ML120RK*</b>	ML100 / ML120	6189712	\$244.79
<b>ML200RK</b>	ML200	9376109	\$485.29



## Rubber Membrane Air Diffusers

- Incredibly strong and are ideal for pond aeration, circulation and destratifying applications
- Unlike air stones these diffusers are easy to clean
- Barbed inlets have multiple size barbs, cut to fit
- Twelve per case (12" has six per case)



Many additional diffuser options available in our Lake & Pond Catalog



Part #	Length	Inlet Air Fitting	Recommended Airflow (cfm)	Maximum Airflow (cfm)	Case Quantity	Stocking Code	Ship Weight	List Price
RAD4	4"	1/4" - 3/8"	.2	1.1	12	610347	1 lb.	\$13.79
RAD6	6"	1/4" - 3/8"	.4	1.7	12	813792	1 lb.	\$18.39
RAD650	6"	1/2" mpt	.4	1.7	12	413792	1 lb.	\$18.39
RAD650W	6"	1/2" mpt weighted	.4	1.7	12	217397	2 lbs.	\$23.19
RAD8	8"	3/8" - 1/2"	.7	2.5	12	617026	1 lb.	\$22.69
RAD850	8"	1/2" mpt	.7	2.5	12	817028	1 lb.	\$22.69
RAD12	12"	3/8" - 1/2"	.9	3.5	6	726842	2 lbs.	\$35.79
RAD1250	12"	1/2" mpt	.9	3.5	6	326849	2 lbs.	\$35.79



## Pro-Glass Alumina Air Stones

Three times stronger than white silica air stones!

- Creates finer bubbles for increased aeration efficiency with no increase in pressure
- Inlet fittings are set into the body of the diffuser, making them much less likely to break or twist loose
- Higher density means self-weighting
- Cleanable with muriatic acid or chlorine
- More resistant to ozone

The Best Choice for aquaculture applications!

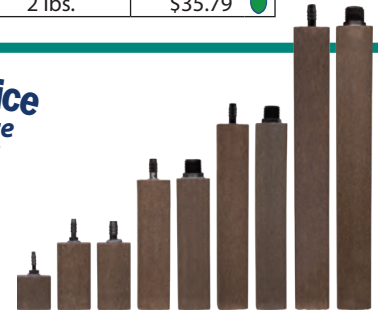

Part #	Dimensions	Fitting Size	Recommended Airflow (cfm)	Stocking Code	Ship Weight	List Price
AS15	1 1/2" x 1 1/2" x 1 1/2"	3/16" barb	.20	29782	1 lb.	\$13.49
AS325	1 1/2" x 1 1/2" x 3"	1/4" barb	.30	715226	1 lb.	\$20.99
AS337	1 1/2" x 1 1/2" x 3"	3/8" barb	.30	615224	2 lbs.	\$20.99
AS637	1 1/2" x 1 1/2" x 6"	3/8" barb	.50	518842	2 lbs.	\$25.99
AS650	1 1/2" x 1 1/2" x 6"	1/2" npt	.50	918849	2 lbs.	\$25.99
AS937	1 1/2" x 1 1/2" x 9"	3/8" barb	.75	628993	2 lbs.	\$39.99
AS950	1 1/2" x 1 1/2" x 9"	1/2" npt	.75	328998	2 lbs.	\$39.99
AS1237	1 1/2" x 1 1/2" x 12"	3/8" barb	1.0	732624	3 lbs.	\$44.99
AS1250	1 1/2" x 1 1/2" x 12"	1/2" npt	1.0	432629	3 lbs.	\$44.99



## Air Diffuser Manifolds

Self-weighted for easy installation

- Includes underlay and check valve to prevent water from filling air line when not in use
- Comes with 6" long rubber membrane air diffusers

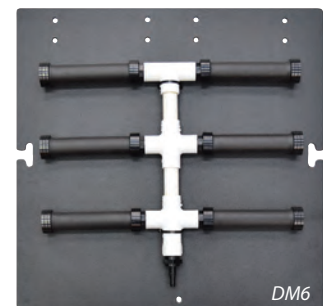
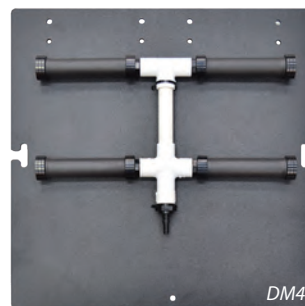

Part #	Number of Diffusers	Recommended Airflow (cfm)	Tubing Connection	Size of Underlay	Stocking Code	Ship Weight	List Price
DM2	2	.8 - 3.4	3/8", 1/2" & 3/8"	11 1/4" x 20"	371246	9 lbs.	\$94.99
DM4	4	1.6 - 6.8	3/8", 1/2" & 3/8"	22 1/2" x 22 1/2"	7110998	11 lbs.	\$147.99
DM6	6	2.4 - 10.2	3/8", 1/2" & 3/8"	22 1/2" x 22 1/2"	8142494	14 lbs.	\$189.99





## "QuickSink" Weighted PVC Airline

Thick-wall PVC hose is guaranteed not to crack or split! Easy installation even in cold weather!

**5 Year Warranty!**

### 3/8" QuickSink Airline (.687" O.D.)

Part #	Length	Stocking Code	Ship Weight	List Price
L3PVC	Cut any length	31134	20 lbs./100'	\$1.50/foot
L3PVC5	50' roll-boxed	344997	10 lbs.	\$59.99
L3PVC1	100' roll-boxed	782493	20 lbs.	\$109.99

### 5/8" QuickSink Airline (1.12" O.D.)

Part #	Length	Stocking Code	Ship Weight	List Price
L6PVC	Cut any length	31951	53 lbs./100'	\$2.60/foot
L6PVC1	100' roll-boxed	5149994	53 lbs.	\$199.99

3/4" diameter and 500' rolls available in our Lake & Pond catalog

### 1/2" QuickSink Airline (1" O.D.)

Part #	Length	Stocking Code	Ship Weight	List Price
L5PVC	Cut any length	31614	44 lbs./100'	\$2.15/foot
L5PVC1	100' roll-boxed	4133420	44 lbs.	\$177.89

Quantity discounts available - call for details!

Many additional diffusers and tubing options available in our Lake & Pond Catalog. More splitters on page 16.

## Splitters

### SS4 Splitters

- Connect end to end to make 8, 12, 16, etc. manifolds
- Handles up to 1200 gph flow
- Can be used with water or air pumps



Part #	Size	Stocking Code	Ship Weight	List Price
SS4	3/4" fpt with 1/2" valves	137497	1 lb.	\$49.99

### Specialty fittings for SS4 outlet to tubing:

SS41238	1/2" fpt x 3/8" barb	71602	1 lb.	\$2.29
SS41212	1/2" fpt x 1/2" barb	31678	1 lb.	\$2.39
SS41234	1/2" fpt x 3/4" barb	42937	1 lb.	\$4.19

### SPL Splitters

- Ideal for water or air
- 1/2" barbed inlets
- 3/8" barbed outlets
- 1/4" ball valves



Part #	Size	Stocking Code	Ship Weight	List Price
SPL382	2 valves	829997	1 lb.	\$39.99
SPL383	3 valves	637495	2 lbs.	\$49.99
SPL384	4 valves	344992	3 lbs.	\$59.99

### Larger aluminum block and valves for higher flow applications

- Ideal for water or air
- 1/2" barbed inlets
- 1/2" barbed outlets
- 1/2" ball valves



Part #	Size	Stocking Code	Ship Weight	List Price
SPL122	2 valves	137494	2 lbs.	\$49.99
SPL123	3 valves	644997	2 lbs.	\$59.99
SPL124	4 valves	852498	3 lbs.	\$69.99

## Mock Rock™ Landscape Boulders

These Mock Rock™ Boulders are ideal for concealing air pumps, water pumps, pond filters, UVs, lighting transformers and other equipment.

- Three sizes available
- Commercial grade construction stands up to the elements and will not fade or crack - made from recycled material
- All rocks come standard with one vent, additional vents can be ordered

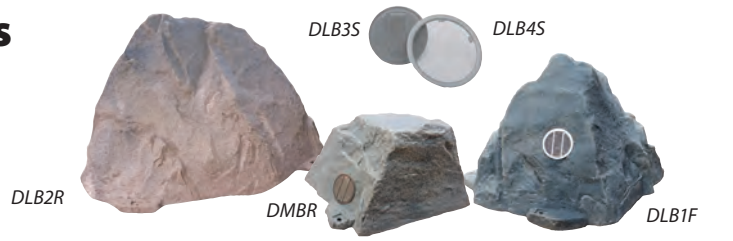

Part #	Color	Dimensions	Vent Included	Case Quantity	Stocking Code	Ship Weight	List Price
DMBR	Brown	19" long x 14" wide x 12" high	One 3" vent	10	882422	4 lbs.*	\$109.89
DLB1F	Gray	30" long x 23" wide x 18" high	One 3" vent	6	6124427	6 lbs.*	\$165.89
DLB1R	Brown	30" long x 23" wide x 18" high	One 3" vent	6	7124428	6 lbs.*	\$165.89
DLB2F	Gray	56" long x 42" wide x 30" high	One 4" vent	4	8329991	28 lbs.†	\$439.99
DLB2R	Brown	56" long x 42" wide x 30" high	One 4" vent	4	2329993	28 lbs.†	\$439.99
DLB3S	—	Additional 3" louvered vent installed	—	—	413345	1 lb.	\$17.79
DLB4S	—	Additional 4" screened vent installed	—	—	622274	1 lb.	\$29.69

\*Dimensional shipping rate applies †Ships motor freight

## 5-in-1 Test Strips

Tests for nitrate, nitrite, total hardness, total alkalinity and pH

- Fresh water use
- Water should be tested regularly to maintain good water quality
- 50 test strips in each bottle



Part #	Stocking Code	Ship Weight	List Price
TS5	918748	1 lb.	\$24.99

## ECO pH+ Tester

- This simple to use tester gives fast, accurate pH readings, is water resistant and floats if dropped in pond
- Controlling pH levels will help balance water chemistry, enhance fish colors, promote spawning and control CO2 level
- Includes protective case
- Auto shutoff, drop shock, 150 hour battery life, water resistant, low battery warning



Four 1.5v button cell batteries included



Part #	Stocking Code	Ship Weight	List Price
KPH	287993	1 lb.	\$109.99

## Koi Medic Salinity Meter

Very accurate, easy to use salinity meter

- Simply turn on and dip into pond, LCD display will display salt content
- Includes protective case
- Auto shutoff, drop shock 6', 150 hour battery life, water resistant, low battery warning, 0.00 - 1.00% range 0.01 resolution, includes four 1.5v button cell batteries



Part #	Stocking Code	Ship Weight	List Price
KMS	6111998	2 lbs.	\$139.99

## Pond & Water Garden Thermometer

- Can be used as a floating thermometer (with cap on) or sinking (with cap off)
- Made from ABS plastic and shatterproof lens
- Reads in both F° and C°
- 3' cord included
- Retail ready packaging
- Twelve per case

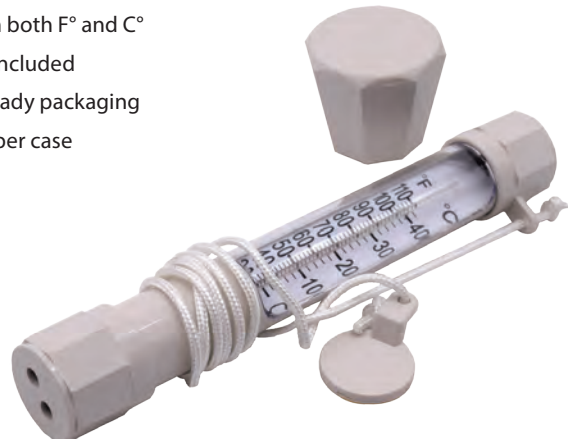

Part #	Stocking Code	Ship Weight	List Price
P180	720244	1 lb.	\$26.99



# ARCHWAY BIO™

*Creating enjoyable waters...naturally.*

Archway Bio is the division of EasyPro® Pond Products that handles all the water treatment production. EasyPro® is a full line blending, packaging and labeling company offering a wide selection of treatments under our own brand as well as offering private label and bulk treatment options. Our products are widely used in the pond, lake, septic and waste water fields by customers around the world.

EasyPro® offers a wider selection of treatment options under our own brand name as well as bulk products for applicators and those using large quantities of material. In addition, we offer private labeling of water treatments (minimum order quantities apply), concentrates and custom blends for customers wanting unique product offerings. Please call us for more information.

## 1 Existing EasyPro® branded products

For the re-seller looking for finished products, we provide an established brand with an extensive line of shelf-ready products. See pages 72-79



## 2 Private Label

For distributors, mail order catalog companies, internet marketing companies or any other re-seller that wants completed finished products. You provide your brand and we'll package it with custom labels.



## 3 Bulk Product

For companies that cannot manufacture. Buy in bulk to repackage and label at your facility.



## 4 Concentrates & Raw Ingredients

For manufacturers that have the ability to blend, package and label products at their own facility

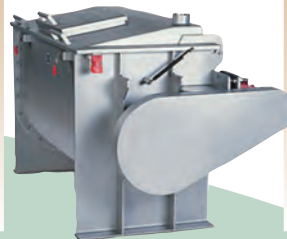

## 5 Customized Products & Packaging

For companies wanting unique product appearance and size. Choice of liquid/powder, tablets/packets and containers



## Pond Salt

Salt is essential for fish health. Koi and goldfish need salt to control their electrolyte balance and also to promote their natural slime coating. This slime coating protects them against fungus and disease.

- Use one to two pounds per 100 gallons, three pounds per 100 gallons when treating for disease
- 99% pure - made from evaporated seawater, will not harm plants when applied correctly
- Reduces fish stress and improves disease recovery



Part #	Description	Size	Case Quantity	Stocking Code	Ship Weight	List Price
EPS10	Pond Salt	10 lb. pail	6	615744	12 lbs.	\$20.99
EPS20	Pond Salt	20 lb. pail	4	326245	23 lbs.	\$34.99
EPS50	Pond Salt	50 lb. pail	2	444997	54 lbs.	\$59.99
EPS50B	Pond Salt	50 lb. box	2	137492	52 lbs.	\$49.99





SINCE 1970

# EasyPro Water Treatments



Designed to make pond care easy, effective & enjoyable

- When used together, these treatments create a balanced eco-system for fish and plants
- Simple dosages eliminate guess work
- Retail ready packaging
- Almost all are Eco-friendly
- Proudly made in the USA



## All-In-One Pond Package

Combines the four most popular water treatments needed for a new pond start-up into one easy package

- Includes four 16 ounce bottles (one each) of Water Clarifier, Water Conditioner, All Season Bacteria and Liquid Barley Extract
- Treats up to 8000 gallon pond

Ideal for New Ponds!



Part #	Description	Case Quantity	Stocking Code	Ship Weight	List Price
WTP4	All-In-One pack	4	726244	5 lbs.	\$34.99

## AQUA DEFEND

**Defend your pond all season long!** This unique water treatment is designed to help keep pond water clean and clear. Aqua Defend™ contains a proprietary blend of all-natural enzyme-producing bacteria along with ingredients to buffer your water and help to keep your rocks and waterfalls clean.\* The strong combination of products will help keep your water feature looking its best!

- Bacteria blend is especially effective at breaking down waste and sludge buildup
- Additive to help prevent buildup on rocks, waterfalls and in streams
- Additive to bind phosphates, buffer pH and help settling of particles
- 1 oz. scoop included in 1 and 2 pound jars
- 8 oz. scoop included in 5 and 10 pound pails
- Apply when water temps are 50°F and above

2 oz. per 1000 gallons



\* When rocks, waterfalls and streams need a more thorough cleaning, use EasyPro® Rock and Waterfall Cleaner on page 80.

Part #	Description	Size	Case Quantity	Stocking Code	Ship Weight	List Price
AQD1	Aqua Defend™	1 lb. jar	24	519493	2 lbs.	\$25.99
AQD2	Aqua Defend™	2 lb. jar	12	235996	3 lbs.	\$47.99
AQD5	Aqua Defend™	5 lb. pail	4	763748	6 lbs.	\$84.99
AQD10	Aqua Defend™	10 lb. pail	4	8119992	11 lbs.	\$159.99
AQD20	Aqua Defend™	20 lb. pail	2	4217493	23 lbs.	\$289.99



EASYPRO.COM





## "All Season" Liquid Pond Bacteria

All season heterotrophic formulation containing beneficial pond bacteria

- Works in water temperatures as low as 38°F so you can use it in Spring, Summer, and Fall!
- Removes ammonia, nitrite, nitrate, phosphates and sludge
- Maintains a healthy, balanced eco-system and reduces pond maintenance



2 fl. oz.  
per  
1000  
gallons



### All Season Liquid Pond Bacteria

Part #	Size	Case Qty.	Stocking Code	Ship Weight	List Price
ASB16	Pint/16 fl. oz.	12	310123	2 lbs.	\$13.49
ASB32	Quart/32 fl. oz.	12	714621	3 lbs.	\$19.49
ASB128	Gallon/32 fl. oz.	4	641993	10 lbs.	\$55.99

## "Seasonal Boost" Cold Weather Bacteria

A proven blend of beneficial pond bacteria, which "naturally" promotes a healthy ecologically balanced ecosystem.

- Allows quicker spring startup and longer late season action
- Use when water temperatures are below 55°F and as low as 38°F to naturally keep pond water clean and clear
- Promotes break down of leaves and organic debris
- Reduces toxins, problem nutrients and murky water
- Safe for use around pets and wildlife



3 fl. oz.  
per  
1000  
gallons



### Seasonal Boost Bacteria

Part #	Size	Case Qty.	Stocking Code	Ship Weight	List Price
SWT16	Pint/16 fl. oz.	12	110125	2 lbs.	\$13.49
SWT32	Quart/32 fl. oz.	12	614623	3 lbs.	\$19.49

## Sludge Remover Bacteria-Dry

This unique formulation is produced using a "no mess" powder in water soluble packets or blocks, which immediately begin to dissolve upon contact with water. Ideal for use with "All Season" Liquid Bacteria above.

- Reduces toxic ammonia and nitrite
- Reduces problem causing nitrate and phosphate
- Reduces murky water caused by organic wastes
- Reduces organic bottom sludge (muck)
- Reduces odors
- Works in water temperatures down to 45°

### One Ounce Water Soluble Packets



1 packet  
per  
1000  
gallons



Part #	Size	Case Qty.	Stocking Code	Ship Weight	List Price
SRB12	12 packets	12	614242	1 lb.	\$18.99
SRB24	24 packets	12	323991	2 lbs.	\$31.99
SRB80	5 lbs.	4	866745	7 lbs.	\$88.99
SRB160	10 lbs.	4	9119997	12 lbs.	\$159.99

### One Ounce Blocks



1 block  
per  
1000  
gallons



Part #	Size	Case Qty.	Stocking Code	Ship Weight	List Price
SBB12	12 blocks	12	915745	1 lb.	\$20.99
SBB24	24 blocks	12	624742	2 lbs.	\$32.99
SBB80	5 lbs.	4	270491	7 lbs.	\$93.99
SBB160	10 lbs.	4	8127497	12 lbs.	\$169.99



## Barley Straw Liquid Extract

This liquid formula contains the active ingredients derived from barley straw and eliminates the need to use unsightly pellets or bales of barley

- All natural liquid formula - easier to use than pellets or bales
- Safe for use with aquatic life and pets
- Keeps water clean and clear
- Works faster than straw



2 fl. oz. per 1000 gallons



### Barley Straw Liquid Extract

Part #	Size	Case Qty.	Stocking Code	Ship Weight	List Price
<b>BSE16</b>	Pint/16 fl. oz.	12	311243	2 lbs.	\$14.99
<b>BSE32</b>	Quart/32 fl. oz.	12	716491	3 lbs.	\$21.99
<b>BSE128</b>	Gallon/128 fl. oz.	4	644243	10 lbs.	\$58.99

## Barley Straw Bales

With exposure to sunlight and oxygen, Barley Straw Bales break down and the released compounds modify a pond's chemistry, improving water quality.

- Lasts approximately three months
- Install replacement bale three weeks prior to removing old bale for continued coverage
- Safe for use with aquatic life and pets



### Barley Straw Bales

Part #	Size	Case Qty.	Stocking Code	Ship Weight	List Price
<b>EBS</b>	1/2 lb. bale	12	39742	1 lb.	\$12.99
<b>EBS1</b>	1 lb. bale	12	912746	2 lbs.	\$16.99

\* Bale sizes are approximate. Packaged by volume, weight may vary slightly

## Barley Straw Pellets

All natural and less messy than traditional barley straw bales

- 100% natural product from concentrated barley straw
- Safe for use with aquatic life and pets
- Fast acting - steady and extended release
- Ideal for use with EasyPro® All Season Bacteria and Phosphate Binder
- 8 oz. scoop included in 5 and 10 lb. pails



1 scoop per 300 gallons



### Barley Straw Pellets

Part #	Size	Case Qty.	Stocking Code	Ship Weight	List Price
<b>EBP5</b>	5 lb. pail	4	318745	7 lbs.	\$24.99
<b>EBP10</b>	10 lb. pail	4	725495	12 lbs.	\$33.99
<b>EBP40</b>	40 lb. bag	1	459993	41 lbs.	\$79.99

## Natural Phosphate Binder

Natural plant-based powder formulation provides a non-chemical alternative to using aluminum sulfate (ALUM) in koi ponds and watergardens

- Binds problem causing phosphate
- Provides approximately 70 beneficial trace minerals
- Buffers pH
- Provides minor flocculation (settling) of suspended particles
- 1 oz. scoop included
- Also available in 45 lb. bulk pail — see our Lake & Pond catalog



1 scoop per 500 gallons



### Natural Phosphate Binder

Part #	Size	Case Qty.	Stocking Code	Ship Weight	List Price
<b>PF2</b>	2 lb. jar	12	917627	3 lbs.	\$23.49
<b>PF7</b>	7 lb. pail	4	152499	9 lbs.	\$69.99
<b>PF15</b>	15 lb. pail	4	586241	17 lbs.	\$114.99



## Water Conditioner

One of the most concentrated water conditioners available. Trusted, economical and ideal for use in water gardens and koi ponds.

- Apply directly to new ponds or immediately after water changes
- Protects fish by buffering pH and instantly neutralizing chlorine and destroying chloramines found in city water.
- Detoxifies heavy metals (including copper) found in both city and well water.
- Maintains a healthy, balanced eco-system and reduces pond maintenance



1 fl. oz.  
per  
1000  
gallons



### Water Conditioner

Part #	Size	Case Qty.	Stocking Code	Ship Weight	List Price
CON16	Pint/16 fl. oz.	12	210491	2 lbs.	\$13.99
CON32	Quart/32 fl. oz.	12	614992	3 lbs.	\$19.99
CON128	Gallon/128 fl. oz.	4	544992	10 lbs.	\$59.99

## Water Conditioner PLUS

All the benefits of EasyPro Water Conditioner PLUS essential electrolytes to reduce fish stress

- Maintains a healthy, balanced eco-system and reduces pond maintenance
- Essential electrolytes enhance skin slime coat and reduce fish stress



1 fl. oz.  
per  
60  
gallons



### Water Conditioner PLUS

Part #	Size	Case Qty.	Stocking Code	Ship Weight	List Price
CNP16	Pint/16 fl. oz.	12	110875	2 lbs.	\$14.49
CNP32	Quart/32 fl. oz.	12	217246	3 lbs.	\$22.99
CNP128	Gallon/128 fl. oz.	4	148742	10 lbs.	\$64.99

## Rock & Waterfall Cleaner

Quickly and effectively clean rocks, waterfalls, water features, fountains, statues, plant pots, etc.



1 lb.  
per 300-  
400 sq. ft.

### Dry Formula

- Powdered formula brings powerful oxygen based cleaning to large ponds or lakes as well as smaller koi ponds, water gardens and aquariums
- Great for use with fish, birds, pets and wildlife
- Lifts debris to pond surface where it can be removed by net or skimmer



Part #	Size	Case Qty.	Stocking Code	Ship Weight	List Price
OXY2	2 lbs.	12	515749	3 lbs.	\$20.99
OXY8	8 lbs.	4	135992	9 lbs.	\$47.99
OXY25	25 lbs.	2	797493	28 lbs.	\$129.99



1 fl. oz.  
per 300  
gallons

### Liquid Formula

- Commercial strength oxygen-based cleaning
- Lifts debris to pond surface where it can be removed by net or skimmer
- Simply pour into area with most active water movement for best mixing
- Safe for use with fish, birds, pets and wildlife



Part #	Size	Case Qty.	Stocking Code	Ship Weight	List Price
OXYL32	Quart/32 fl. oz.	12	414242	3 lbs.	\$18.99
OXYL128	Gallon/128 fl. oz.	4	928497	9 lbs.	\$37.99

## Water Clarifier

This concentrated formula quickly clears murky pond water by attracting suspended particles.

- Attracts suspended particles together allowing them to settle out of water column
- Best when used with EasyPro® Pond Bacteria



1 fl. oz. per 1000 gallons



### Water Clarifier

Part #	Size	Case Qty.	Stocking Code	Ship Weight	List Price
<b>EWC16</b>	Pint/16 fl. oz.	12	79743	2 lbs.	\$12.99
<b>EWC32</b>	Quart/32 fl. oz.	12	915745	3 lbs.	\$20.99
<b>EWC128</b>	Gallon/128 fl. oz.	4	638992	10 lbs.	\$51.99

## pH Down • pH Up

Safe & effective way to control pH levels in pond water

- Treats fresh or salt water
- Phosphate free
- Maintains a healthy, balanced ecosystem and reduces pond maintenance
- Safe for use with fish and plants



1 fl. oz. per 600 gallons



### pH Down / pH Up

Part #	Size	Case Qty.	Stocking Code	Ship Weight	List Price
<b>EPHU16</b>	pH Up-Pint/16 fl. oz.	12	110495	2 lbs.	\$13.99
<b>EPHD16</b>	pH Down-Pint/16 fl. oz.	12	311249	2 lbs.	\$14.99
<b>EPHD128</b>	pH Down-Gal./128 fl. oz.	4	357746	10 lbs.	\$76.99

## Pond and Water Feature Dyes

Choose from original blue, the increasingly popular black or "Serenity", a perfect blend of the blue and black dyes

- Pond dyes help filter out UV rays from the sun
- Concentrated formula
- Does not stain or harm fish or plants once dispersed
- Blue dye gives water a classic blue look
- Black dye gives a more "reflective" look
- Serenity dye is a blackish-blue combination



1 fl. oz. per 1000 gallons



### Pond and Water Feature Dyes

Part #	Size	Case Qty.	Stocking Code	Ship Weight	List Price
<b>PD16</b>	Blue-Pint/16 fl. oz.	12	29745	2 lbs.	\$12.99
<b>PD16B</b>	Black-Pint/16 fl. oz.	12	79742	2 lbs.	\$12.99
<b>PD16C</b>	Serenity-Pint/16 fl. oz.	12	49741	2 lbs.	\$12.99

## Defoamer

Quickly eliminates foam in koi ponds, water gardens, fountains and statues

- Concentrated formula
- Can be used in water gardens, koi ponds, fountains, fish hauling trucks, etc.
- Compatible with most other water conditioners and antibiotics.



1 fl. oz. per 1000 gallons



### Defoamer

Part #	Size	Case Qty.	Stocking Code	Ship Weight	List Price
<b>DEF16</b>	Pint/16 fl. oz.	12	110492	2 lbs.	\$13.99
<b>DEF128</b>	Gallon/128 fl. oz.	4	546495	10 lbs.	\$61.99







Our most popular water treatment products in bulk packages. Ideal for service and maintenance companies, refill programs at retail stores or large volume users where point-of-sale packaging is not a concern.

*Save money buying in bulk!*

## Bulk Treatments - Dry

### Sludge Remover Bacteria 3 gr. Pellets



- 50 lb. box bulk 3 gram pellets

Part #	Stocking Code	Ship Weight	List Price
<b>ABB-50B</b>	3433997	53 lbs.	\$619.99

### Sludge Remover Bacteria 1 oz. Blocks



- 50 lb. box bulk 1 oz. blocks

Part #	Stocking Code	Ship Weight	List Price
<b>SBB-50B</b>	2468998	53 lbs.	\$669.99

### Sludge Remover Bacteria 1 oz. Packets



- 50 lb. box bulk 1 oz. water soluble packets

Part #	Stocking Code	Ship Weight	List Price
<b>SRB-50B</b>	2454997	53 lbs.	\$649.99

### Pond-Vive Bacteria 8 oz. Packets

- Reduce sludge buildup
- Eliminate pond odors
- Reduce oxygen demand
- Eliminate excess nutrients
- Improve water clarity
- Safe for fish, family and animals
- 50 lb. box bulk 8 oz. water soluble packets



Part #	Size	Stocking Code	Ship Weight	List Price
<b>PBX-50B</b>	8 oz. packets	2440998	53 lbs.	\$629.99

### Pond-Vive Bacteria Loose Powder

- Reduce sludge buildup
- Eliminate pond odors
- Reduce oxygen demand
- Eliminate excess nutrients
- Improve water clarity
- Safe for fish, family and animals
- 50 lb. box bulk loose powder includes 8 oz. scoop



Part #	Size	Stocking Code	Ship Weight	List Price
<b>PB50XL</b>	Loose powder 50 lb.	3412993	53 lbs.	\$589.99

## Bulk Treatments - Liquid

### All Season Liquid Pond Bacteria

- Works in water temperatures down to 38°F
- Removes ammonia, nitrites, nitrates, phosphates and sludge
- Maintains a healthy, balanced ecosystem



55 gallon drum

Part #	Stocking Code	Ship Weight	List Price
<b>ASB-55G</b>	21274998	500 lbs.	\$1699.99

### Barley Straw Liquid Extract

- All natural liquid formula - easier to use than pellets or bales
- Safe for use with aquatic life and pets
- Keeps water clean and clear
- Works faster than straw



55 gallon drum

Part #	Stocking Code	Ship Weight	List Price
<b>BSE-55G</b>	71724994	500 lbs.	\$2299.99

### Water Clarifier

- Concentrated formula clears murky water fast
- Attracts suspended particles together allowing them to settle out of water column



55 gallon drum

Part #	Stocking Code	Ship Weight	List Price
<b>EWC-55G</b>	31349992	500 lbs.	\$1799.99



### Water Conditioner

- Removes chlorine and destroys chloramines
- Detoxifies heavy metals
- Apply directly to new ponds or immediately after water changes



55 gallon drum

Part #	Stocking Code	Ship Weight	List Price
<b>CON-55G</b>	12099993	500 lbs.	\$2799.99



### Water Conditioner PLUS

- Removes ammonia, chlorine and destroys chloramines
- Detoxifies nitrite and heavy metals
- Adds electrolytes, enhances skin slime coat and reduces stress



55 gallon drum

Part #	Stocking Code	Ship Weight	List Price
<b>CNP-55G</b>	82549995	500 lbs.	\$3399.99



### Pond-Vive L

#### Liquid lake and pond bacteria

A convenient alternative to Pond-Vive in a liquid

- Similar formula to Pond-Vive powder, can be used to treat golf course ponds, farm ponds, municipal areas and similar applications
- Works to remove ammonia, nitrates, phosphates & sludge
- Application rate is one gallon per surface acre weekly for four weeks, then every two to four weeks for maintenance
- Two gallons will treat 1/4 acre pond for 10-16 weeks

Available in  
**55 gallon drum**  
**250 gallon tote**  
for large bodies  
of water



Part #	Size	Stocking Code	Approx. Ship Weight	List Price
<b>PB-55G</b>	55 Gallon Drum	81349991	490 lbs.	\$1799.99
<b>PB250T</b>	250 Gallon Tote	53224993	2100 lbs.	\$4299.99

### Concentrated Blue Lake Dye

Now available in bulk!



30 & 55 gallon drums

- One quart is equal to one gallon of other dyes on the market
- This is a non-toxic and harmless pond dye for use in ponds and lakes
- Waters can be used for swimming and irrigation once product is dispersed
- Compatible with most aquatic herbicides and algaecides
- See our Lake & Pond Management Catalog for other dye colors



Part #	Size	Stocking Code	Approx. Ship Weight	List Price
<b>ECPD-30G</b>	30 Gallon Drum	41959997	300 lbs.	\$2799.99
<b>ECPD-55G</b>	55 Gallon Drum	63499997	500 lbs.	\$4999.99





## GreenClean — Granular Algaecide

Ideal string algae control in ponds, waterfalls, fountains and streams. GreenClean Granular works through oxidation, breaking down algae cells on contact. Dead matter floats to the surface where it is removed by a skimmer or a net. Ideal for use with bacteria. Once it kills algae, bacteria go to work cleaning up organic material.

### Features & Benefits

- Kills algae on contact — visible results in minutes
- For use in water features containing live fish and plants
- Effective, eco-friendly chemistry — no copper residue
- Controls string algae in ponds, streams or waterfalls
- An EPA registered, organic algaecide, so you can feel good about what is in your water
- Eco-friendly chemistry and Organic Materials Review Institute (ORMI) listed

### Application Rates & Tips for Green Clean Granular

Use 1/2 pound (1 cup) per 1000 gallons of water to control existing problems, use 1/4 pound (1/2 cup) per 1000 gallons as maintenance dosage

1. Apply early in the morning on clear sunny day
2. Turn off circulation
3. Apply to affected areas, including waterfalls and streams
4. Turn circulation back on after 10-20 minutes
5. Skimming/netting dead algae helps prevent further algae growth

**Note: Always read and follow label directions**

Part #	Description	Size	Treats Up To	Case Quantity	Stocking Code	Ship Weight	List Price
GC2	GreenClean granular	2.5 lbs.	5000 gallons	12	218744	3 lbs.	\$24.99
GC8	GreenClean granular	8 lbs.	16,000 gallons	4	640121	9 lbs.	\$53.49
GC20**	GreenClean granular	20 lbs.	7 acre ft	—	474993	24 lbs.	\$99.99
GC50**	GreenClean granular	50 lbs.	17 acre ft	—	3129747	55 lbs.	\$172.99

\*\*Does not qualify for case discount



## Best Seller!



## AlgAway 5.4 Algaecide

### Ideal treatment for string algae

- Controls algae growth and eliminates green water in ponds
- This product is safe for use with fish and plants (not snails, shrimp and crustaceans)
- Keeps your water surface clear and beautiful
- For ponds with heavy algae growth, first clean off excess algae from the sides of the pond and any ornaments or water features - then add one cap full per 60 gallons of water for complete algae treatment
- When treating a pond with fish, be sure it is well aerated
- Not for sale in Rhode Island

### Application Rates

- 1 fl. oz. treats 350 gallons
- 16 fl. oz. treats 5678 gallons
- 32 fl. oz. treats 11,356 gallons
- 128 fl. oz. treats 45,424 gallons
- 320 fl. oz. treats 113,560 gallons

**Note: Always read and follow label directions**

Part #	Description	Size	Case Quantity	Stocking Code	Ship Weight	List Price
ALG16	AlgAway 5.4 - pint	16 fl. oz.	12	312747	2 lbs.	\$16.99
ALG32	AlgAway 5.4 - quart	32 fl. oz.	12	819494	3 lbs.	\$25.99
ALG128	AlgAway 5.4 - gallon	128 fl. oz.	4	466743	10 lbs.	\$88.99
ALG320	AlgAway 5.4 - 2.5 gallon	320 fl. oz.	2	2119249	23 lbs.	\$158.99



## AlgAway 60

- EPA registered algae control for ponds, formal fountains, Just-A-Falls and other bodies of water not containing fish or plants, safe for irrigation, turf and shrubs
- **Not for use in waters containing fish or aquatic plants**
- Highly concentrated formula. One ounce treats up to 1000 gallons of water
- Eliminates most planktonic and filamentous algae quickly and efficiently and there's no phytotoxicity so water is safe for irrigation, turf and shrubs
- Eliminates plugging of irrigation lines and pumps
- Not for sale in California, New York, Rhode Island or Canada

Part #	Description	Size	Case Quantity	Stocking Code	Ship Weight	List Price
ALG60Q	AlgAway 60 - quart	32 fl. oz.	12	159994	3 lbs.	\$79.99
ALG60G	AlgAway 60 - gallon	128 fl. oz.	4	5187493	10 lbs.	\$249.99



## Aquatic Planting Media

- Kiln fired, will not break down, float or cloud pond water
- All inert ingredients that retain oxygen and are safe for all fish and plants
- 10% natural minerals, containing no algae-promoting nutrients, fertilizer, peat or compost
- Not for sale in Oregon

Part #	Description	Size	Case Quantity	Stocking Code	Ship Weight	List Price
APM10	Aquatic planting media	10 lbs.	6	417249	11 lbs.	\$22.99
APM20	Aquatic planting media	20 lbs.	3	733746	22 lbs.	\$44.99



## Broad Spectrum Disease Treatment

- The premier product in the field of disease treatment because it is formulated with malachite green chloride instead of the more toxic oxalate salt
- The most effective treatment for the control of diseases caused by ich, costia, trichodina, chilodonella, oodinium and fungal infections

Part #	Description	Size	Case Quantity	Stocking Code	Ship Weight	List Price
BSDT16	Broad Spectrum - pint	16 fl. oz.	12	723246	2 lbs.	\$30.99
BSDT32	Broad Spectrum - quart	32 fl. oz.	12	635995	3 lbs.	\$47.99



## Spring/Summer Cleaner

- Accelerate the breakdown of leaves, twigs and other accumulated dead organic waste
- Helps to jump start your pond to a healthier environment in the spring
- Each box contains eight 2 ounce water soluble packets of cellulase enzymes and cellulase producing bacteria

Part #	Description	Size	Case Quantity	Stocking Code	Ship Weight	List Price
MLSC	Spring/Summer cleaner	1 lb.	12	329991	3 lbs.	\$39.99







## Microbe-Lift Bacteria

- 100% natural, safe and beneficial bacteria and will not harm fish or plants
- Reduces ammonia, nitrogen levels and noxious odors; improves dissolved oxygen levels
- Dissolves away organic sludge and slime
- Microbe-Lift Bacteria works in water temperatures below 55° but will not be harmed if frozen; bacteria will retain viability after thawing



Part #	Description	Size	Case Quantity	Stocking Code	Ship Weight	List Price
MLBP	Microbe-Lift bacteria - pint	16 fl. oz.	12	617994	2 lbs.	\$23.99
MLBQ	Microbe-Lift bacteria - quart	32 fl. oz.	12	826993	3 lbs.	\$35.99
MLBG	Microbe-Lift bacteria - gallon	128 fl. oz.	6	264491	10 lbs.	\$85.99



## Professional Blend Microbe-Lift Bacteria

**Maintains a healthy environment for pond, fish and plants all in one treatment!**

- Allows for treatment of all the areas of water quality in one easy step
- Ideal for pond maintenance companies - eliminates the need for multiple bottles of product



Part #	Description	Size	Case Quantity	Stocking Code	Ship Weight	List Price
PBLQ	Professional Blend bacteria - quart	32 fl. oz.	12	423243	2 lbs.	\$30.99
PBLG	Professional Blend bacteria - gallon	128 fl. oz.	6	856244	11 lbs.	\$74.99



## Microbe-Lift Sludge Away

**A special blend of bacteria specifically designed to remove sludge, this is especially helpful in ponds that have rock bottoms.**

- Binds phosphates and helps improve pond clarity
- 100% active ingredients that disperse quickly



Part #	Description	Size	Case Quantity	Stocking Code	Ship Weight	List Price
MLSQ	Sludge Away - quart	32 fl. oz.	12	326241	2 lbs.	\$34.99
MLSG	Sludge Away - gallon	128 fl. oz.	6	363741	11 lbs.	\$84.99

## Autumn/Winter Prep

- Quart packages contain one quart of liquid bacteria and four 2 ounce water soluble packets with a blend of cellulase enzymes, cellulase producing bacteria and a cold weather bacteria
- Gallon kits are ideal for treating large ponds, these kits include one gallon of liquid bacteria and eight 2 ounce water soluble packets

See EasyPro® Seasonal Boost Package alternative on page 78



Part #	Description	Size	Case Quantity	Stocking Code	Ship Weight	List Price
MLAP	Autumn/Winter Prep - quart	32 fl. oz.	12	329996	3 lbs.	\$39.99
MLAK	Autumn/Winter Prep - gallon	128 fl. oz.	4	389994	10 lbs.	\$119.99



EasyPro offers a wide variety of complete filters from the entry level Eco-Clear to the top of the line Skid Mount Packages.

*We have a filter for nearly every application!*



We also offer a wide variety of replacement media for solids and biological filtration.



## Submersible Pump/Filter/UV Combo

Combines pump, filter, UV and fountain into one complete unit. Simple effective filtration ideal for small and pre-formed ponds.

- 11 watt UV for crystal clear water
- 675 gph pump with 16' power cord, 48 watts
- Mechanical and biological filtration media included
- Reusable filter pad is easy to clean
- One year warranty
- Swivel joint for easy leveling of fountain nozzles

ESF1250 with three tier nozzle and diverter valve



**Includes three fountain nozzles and diverter valve!**

*\* Sizes shown below are approximate. Actual dimensions depend on pump depth and extensions used.*



14" high x 20" diameter\*



34" high x 36" diameter\*



24" high x 40" diameter\*

Part #	Max Pond Size	UV/ Watts	Max. gph Flow	Case Quantity	Stocking Code	Ship Weight	List Price
ESF1250	1250 gallons	11	640	4	3188797	11 lbs.	\$235.99



## ESF1250 Replacement Parts



Part #	Description	Stocking Code	List Price
ESF1250B	UV bulb	831992	\$39.99
ESF1250S	UV sleeve	423327	\$31.09
ESF1250F	Filter pads	315891	\$21.19
ESF1250I	Impeller for pump	214775	\$19.69





## Eco-Clear Pressurized Pond Filters

EasyPro® Eco-Clear Pressure Filters provide excellent, dual filtration for ponds. Ideal for preformed ponds and small water features needing effective filtration.

- Sturdy filter housings – can be partially buried up to cleaning ring for easy concealment
- Dual filtration – filter pads collect solid debris while bio-media provides biological filtration
- Optional UV for crystal clear water
- Filters are easy to disassemble and clean, making maintenance a snap!
- Multi-step connectors – inlet/outlet fittings accept a variety of tubing sizes
- Three year warranty

### EC2600 and EC3900 unit bonus features

- Cleaning indicator – shows when filter needs to be cleaned
- Backwash valve to extend time between full cleanouts



Optional UV



Cleaning Indicator



Backwash Valve



Backwash Port



Multi-Step Connectors



Sturdy Filter Housings



Dual Filtration

## Complete Pond Filtration Made Simple

Eco-Clear Pond Filters are also available in complete kits with our new Eco-Clear Pumps. See next page for complete kits and page 89 for Eco-Clear Pumps.



Model	UV Wattage	Cord Length	Pond Size*	Fittings Included	Unit Size W x D x H
EC1300	/	/	650 gallons with fish	1/2", 3/4", 1" Step barb fitting (2)	15" x 12" x 16"
EC1300U	9W	16 ft.	1300 gallons without fish		15" x 12" x 16"
EC2600	/	/	1300 gallons with fish	1", 1 1/4", 1 1/2" Step barb fitting (3)	21" x 15" x 18"
EC2600U	18W	16 ft.	2600 gallons without fish		21" x 15" x 18"
EC3900	/	/	1950 gallons with fish	1", 1 1/4", 1 1/2" Step barb fitting (3)	21" x 15" x 24"
EC3900U	24W	16 ft.	3900 gallons without fish		21" x 15" x 24"

\*Fish load, feeding rates, amount of sunlight and other factors affect actual maximum gallons filtered.

Part #	UV	Recommended Max gph Flow	Stocking Code	Ship Weight	List Price
EC1300	No	1300	2104991	10 lbs.	\$139.99
EC1300U	9 Watt	1300	6149994	11 lbs.	\$199.99
EC2600	No	2600	3164991	17 lbs.	\$219.99
EC2600U	18 Watt	2600	8224997	19 lbs.	\$299.99
EC3900	No	3900	7202498	19 lbs.	\$269.99
EC3900U	24 Watt	3900	4269993	21 lbs.	\$359.99





SINCE 1970

# Eco-Clear Pond Filtration Kits

## Eco-Clear Complete Pond Filtration Systems

Pond filtration has never been easier!  
 These kits combine our new Eco-Clear UV Pressure Filters and Submersible Pond Pumps for complete pond filtration.

**Included:**

- Eco-Clear Submersible Pond Pump (details on page 102)
- Eco-Clear Pressurized Pond Filter (details on page 88)
- Kink free tubing and clamps

see chart below for details



Part #	Max Pond Size	Filter	UV Wattage	Pump	Max Flow gph	Kink-Free Tubing Included	Stocking Code	Ship Weight	List Price
ECK13U	1300 gallons <sup>†</sup>	EC1300U	9 Watts	EPS1300	1400*	10 ft. - 1"	2333768	25 lbs.**	\$445.09
ECK13UDX	1300 gallons <sup>†</sup>	EC2600U	18 Watts	EPS1300	1400*	25 ft. - 1¼"	9410053	34 lbs.**	\$546.79
ECK26U	2600 gallons <sup>†</sup>	EC2600U	18 Watts	EPS2500	2480*	25 ft. - 1¼"	7438391	36 lbs.**	\$584.59
ECK39U	3900 gallons <sup>†</sup>	EC3900U	24 Watts	EPS3700	3680*	25 ft. - 1¼"	8515116	40 lbs.**	\$686.89



<sup>†</sup> Fish load, feeding rates, amount of sunlight and other factors affect actual maximum gallons filtered.  
<sup>\*</sup> Performance data provided for reference only and may vary slightly. <sup>\*\*</sup> Dimensional shipping rate applies



The Eco-Clear Pump sends dirty pond water to the pressurized filter.

The dirty water passes through multiple densities of foam filters and is cleaned of solid debris.

Water then passes through bio-media for excellent biological filtration.

Filters in these kits have high-intensity UV lights that destroy algae cells, eliminating green water. Cleaned water is returned to your pond.

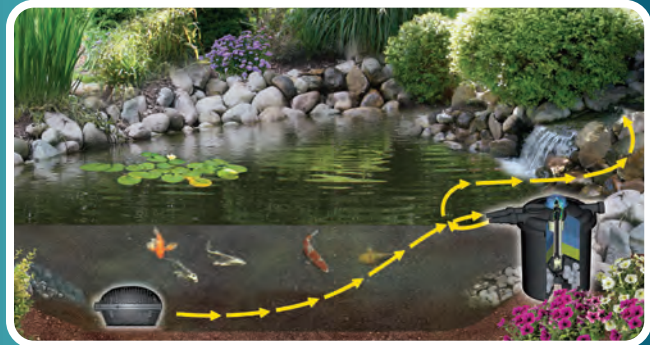

Part #	Description	Stocking Code	List Price
--------	-------------	---------------	------------

**Replacement UV Bulbs, Sleeves and Transformers**

EC13UB	9 Watt UV Lamp for EC1300U Filter	621743	\$28.99
EC13US	Quartz Sleeve Assembly for EC1300U Filter	324748	\$32.99
EC13UT	Replacement Transformer for EC1300U Filter	844997	\$59.99
EC26UB	18 Watt UV Lamp for EC2600U Filter	727742	\$36.99
EC26US	Quartz Sleeve Assembly for EC2600U Filter	226245	\$34.99
EC26UT	Replacement Transformer for EC2600U Filter	544991	\$59.99
EC39UB	24 Watt UV Lamp for EC3900U Filter	132246	\$42.99
EC39US	Quartz Sleeve Assembly for EC3900U Filter	627743	\$36.99
EC39UT	Replacement Transformer for EC3900U Filter	544995	\$59.99

**Replacement Filter Pads, O-Rings, Clamps and Barb Hose Connector Sets**

EC13F	Filter Pads (Includes 1 Coarse Pad, 1 Fine Pad) for EC1300/EC1300U	618748	\$24.99
EC26F	Filter Pads (Includes 1 Coarse, 1 Fine) for EC2600/EC2600U	733742	\$44.99
EC39F	Filter Pads (Includes 1 Coarse, 1 Medium, 1 Fine) for EC3900/EC3900U	248746	\$64.99
EC13L	O-Ring - Seals Lid and Tub for EC1300/EC1300U	57495	\$9.99
EC2639L	O-Ring - Seals Lid and Tub for EC2600/EC2600U/EC3900/EC3900U	711243	\$14.99
EC13C	Clamp - Secures Lid for EC1300/EC1300U	29745	\$12.99
EC2639C	Clamp - Secures Lid for EC2600/EC2600U/EC3900/EC3900U	614997	\$19.99
EC13BK	Barb Hose Connector Set (Includes 2 Connectors, 2 Nuts, 2 Gaskets) for EC1300/EC1300U	814992	\$19.99
EC2639BK	Barb Hose Connector Set (Includes 3 Connectors, 3 Nuts, 3 Gaskets) for EC2600/EC2600U/EC3900/EC3900U	322495	\$29.99



# Filter & UV Replacement Parts



SINCE 1970



## Filter Replacement Parts

For previous ECF Canister Filters Sold 2020 & Earlier



EC13BK / EC2639BK

Part #	Description	Stocking Code	List Price
--------	-------------	---------------	------------

### Inlet/Outlet Hose Barb Set

EC13BK	For ECF10 units	714992	\$19.99
EC2639BK	For ECF25 & 40 units	322495	\$29.99

**O-Ring Kits** Include large o-ring for filter and two o-rings for hose barbs. Ship weight 1 lb. each.

ECFK1	For ECF10 units	417623	\$23.49
ECFK2	For ECF25 & 40 units	815748	\$20.99

### Filter Pad Sets

EC13F	For ECF10 units (2 pads)	518749	\$24.99
EC39F	For ECF25 & 40 units (3 pads)	948749	\$64.99



Part #	Description	Stocking Code	List Price
--------	-------------	---------------	------------

### UV Bulbs & Sleeves

10UB	7 watt bulb for ECF10U	435248	\$46.99
10US	7 watt sleeve for ECF10U	944843	\$59.79
25UB	9 watt bulb for ECF25U	637495	\$49.99
25US	9 watt sleeve for ECF25U	549872	\$66.49
40UB	13 watt bulb for ECF40U	140492	\$53.99
40US	13 watt sleeve for ECF40U	250245	\$66.99



EC39F

## EPUV Clarifier Replacement Parts

18W and 36W Sold 2022 & Earlier



Part #	Description	Stocking Code	Ship Weight	List Price
EP18BN	18w bulb	137493	2 lbs.	\$49.99
EP36BN	36w bulb	247996	2 lbs.	\$63.99
EP18SN	18w sleeve	752495	3 lbs.	\$69.99
EP36SN	36w sleeve	563747	3 lbs.	\$84.99

## EPUV Commercial UV Clarifier

Replacement Parts - 35W, 55W, 75W Sold 2022 & Earlier

Part #	Size	Stocking Code	Ship Weight	List Price
--------	------	---------------	-------------	------------

### Transformers

EPUVT35	35w	489995	3 lbs.	\$119.99
EPUVT55	55w	5100793	4 lbs.	\$134.39
EPUVT75	75w	5110392	4 lbs.	\$147.19

### Bulbs

EPUVB35	35w	950993	2 lbs.	\$67.99
EPUVB55	55w	159992	2 lbs.	\$79.99
EPUVB75	75w	269745	2 lbs.	\$92.99

### Sleeves

EPUVS35	35w	747691	2 lbs.	\$63.59
EPUVS55	55w	254742	2 lbs.	\$72.99
EPUVS75	75w	366293	2 lbs.	\$88.39

## PRO-CLEAR™ UV

### UV Clarifier Replacement Parts

PC18W and PC36W



Part #	Description	Stocking Code	Ship Weight	List Price
PC18BN	18w bulb	918742	2 lbs.	\$24.99
PC36BN	36w bulb	720999	2 lbs.	\$27.99
PC18SN	18w sleeve	422498	3 lbs.	\$29.99
PC36SN	36w sleeve	824743	3 lbs.	\$32.99

## PRO-CLEAR™ UV ULTRA

### Stainless UV Clarifier Replacement Parts

PCU35W, PCU55W, PCU75W, PCU110W, PCU150W, PCU225W

Part #	Size	Stocking Code	Ship Weight	List Price
--------	------	---------------	-------------	------------

### Transformers

PCUT35	35w	674998	3 lbs.	\$99.99
PCUT55	55w	482492	4 lbs.	\$109.99
PCUT75	75w	393741	4 lbs.	\$124.99

### Bulbs

PCUB35	35w	750992	2 lbs.	\$67.99
PCUB55	55w	259996	2 lbs.	\$79.99
PCUB75	75w	369749	2 lbs.	\$92.99

### Sleeves

PCUS35	35w	238996	2 lbs.	\$51.99
PCUS55	55w	844991	2 lbs.	\$59.99
PCUS75	75w	752493	2 lbs.	\$69.99



## Retrofit Blower Kits

for PBF Pressurized Bead Filters

Part #	Fits Pressurized Bead Filter:	Stocking Code	Ship Weight	List Price
BRK15	PBF1800, PBF3600 with 1½" fittings	2351991	12 lbs.	\$439.99
BRK20	PBF6000, PBF10,000 with 2" fittings	8359997	12 lbs.	\$449.99



800-448-3873

## PRO-CLEAR™ UV Ultraviolet Clarifiers

Durable, high quality construction.  
Engineered for ultraviolet efficiency and long life.

- Tough, impact resistant housing
- Multi-step barbs for ¾", 1", 1¼" and 1½" tubing
- 115v weatherproof transformer with 6' cord
- Five year warranty on housing
- One year warranty on transformer, UV bulb and quartz sleeve
- Replacement bulbs and sleeves sold on page 90



PC18W

### PRO-TIP

These in-line units can be easily concealed with Mock Rock™ Landscape Boulders found on page 74.



Order DMBR to conceal PC18W



Order DLB1F to conceal PC36W



Part #	Watts	Maximum Flow gph	Maximum Pond Size*	Stocking Code	Ship Weight	List Price
PC18W	18	1800 gph	2800 Gallons	6149995	7 lbs.	\$199.99
PC36W	36	3900 gph	3600 Gallons	3202496	9 lbs.	\$269.99

\*Fish load, filtration capacity and other factors affect actual maximum pond size

## PRO-CLEAR™ UV ULTRA Stainless Steel UV Clarifiers

High strength, stainless steel construction. Engineered for maximum flow rate, ultraviolet efficiency and long life.

- Polished stainless interior reflector increases light reflection up to 35%
- Dual inlets & outlets for multiple plumbing options
- Weatherproof transformer
- UV sight glass window safely shows when unit is operating
- 2" PVC inlet/outlets — includes union connections
- UV-C grade bulbs have 9000 hour life rating
- Five year warranty on housing
- One year warranty on transformer, UV bulb and quartz sleeve
- Replacement bulbs and sleeves sold on page 90



PCU35W



PCU55W



PCU75W



PCU110W



PCU150W



PCU225W

Part #	Description	Max. Flow	Max. Pond Size*	Qty./Size Bulb	Power Cord	Stocking Code	Ship Weight	List Price
PCU35W	35w Clarifier	2800 gph	2800 Gallons	1 / 35 watt	1 / 16'	7314995	10 lbs.	\$419.99
PCU55W	55w Clarifier	3600 gph	3600 Gallons	1 / 55 watt	1 / 16'	4337495	12 lbs.	\$449.99
PCU75W	75w Clarifier	4800 gph	4800 Gallons	1 / 75 watt	1 / 16'	7374992	15 lbs.	\$499.99
PCU110W	110w Clarifier	6500 gph	6500 Gallons	2 / 55 watt	2 / 16'	3644994	23 lbs.	\$859.99
PCU150W	150w Clarifier	6500 gph	6500 Gallons	2 / 75 watt	2 / 16'	3749998	29 lbs.	\$999.99
PCU225W	225w Clarifier	9000 gph	9000 Gallons	3 / 75 watt	3 / 16'	51124995	43 lbs.	\$1499.99

\*Fish load, filtration capacity and other factors affect actual maximum pond size





## Pressurized Bead Filters

Mechanical and biological filtration for water gardens, koi ponds and hybrid ponds

### Filter Features

- Uses six position control head
- Strong, heavy duty, polyethylene filter body
- Has clear section to monitor cleaning cycle
- Simple to set up and assemble, great filters for fish displays
- Free unions included for plumbing lines

**3 Year Warranty!**



Ultimate Tube Media included for maximum filtration and minimal back pressure  
Replacement media sold on page 95



### The POWER OF THE AIR BLOWER



**Consider it a ninja pre-wash cycle for filters!**  
Regular backflushing is required to clear bead filters of waste. Using an Air Blower first to loosen debris makes backflushing faster, more efficient and more effective.

**\$ Saves on electrical costs**

Inefficient high-pressure and two-speed pumps are great for backflushing but are expensive to operate.

Using an Air Blower first to loosen debris allows the backflush to be completed with an energy-efficient, low-head circulation pump.

**⚡ Faster backflushing using less pond water**

Agitating the beads with an air blower prior to backflushing reduces the amount of pond water needed to clean the filter when backflushing.

Without an air blower, it can take more water and more backflush cycles to clean the filter when only the circulation pump is used.

**💧 Improves filtration capabilities**

Preventing the beads from clumping together as the filter ages, the Air Blower helps to keep the surface area of the beads cleaner for maximum filtration.

*For filters with the backflush blower option, look for part numbers below that end in "BL".*

Part #	Maximum Pond Size	Diameter** x Height**	Inlet/Outlet Size	Maximum gpm†	Stocking Code	Ship Weight	List Price
<b>PBF1800*</b>	1800 Gallons	16" x 31"	1½"	30	3599993	38 lbs.*	\$799.99
<b>PBF1800BL</b>	PBF1800 filter with backflush blower	—	1½"	30	4951986	38, 12 lbs.*	\$1239.99
<b>PBF3600</b>	3600 Gallons	19" x 36"	1½"	50	5787495	62 lbs.*	\$1049.99
<b>PBF3600BL</b>	PBF3600 filter with backflush blower	—	1½"	50	61139487	62, 12 lbs.*	\$1489.99
<b>PBF6000</b>	6000 Gallons	24" x 43"	2"	70	81087494	45, 40 lbs.*	\$1449.99
<b>PBF6000BL</b>	PBF6000 filter with backflush blower	—	2"	70	61447483	45, 40, 12 lbs.	\$1899.99
<b>PBF10000</b>	10000 Gallons	31" x 51"	2"	90	61649993	139 lbs.	\$2199.99
<b>PBF10000BL</b>	PBF10000 filter with backflush blower	—	2"	90	92009985	151 lbs.	\$2649.99

**Retrofit Blower Kits sold on page 90**  
(For filters previously bought without blower option)

\*\*Height is measured from floor to top of handle. \*\*Diameter measurement is tank only, control valve not included.  
†Higher flow rates are possible but filter effectiveness is reduced. \*Dimensional shipping rate applies





SINCE 1970

# EasyPro Pond Filters

## Deluxe Skid Mounted Pond Filtration Systems Plug and Go!

These deluxe filtration systems combine a pressurized bead filter with an external self priming pump and a UV clarifier into one completely plumbed, ready to install, "plug and go" filter system. Simply plumb your incoming and outgoing water lines and you are ready to go!

- All plumbing is completed and unions included at all connection points allowing for easy maintenance down the road
- Electrical post complete with 115v power outlet and 15' power cord for easy "plug and go" installation
- Plumbing includes a bypass line around filter/UV
- Filter comes complete with backflush blower upgrade



SMF3600



SMF6000

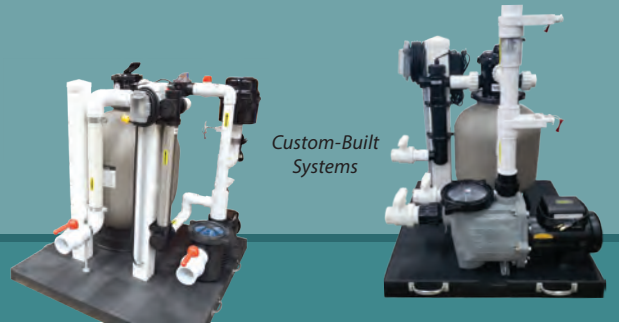

Custom-Built Systems

### We also custom-build to your specs!

Three year warranty on entire filtration package (excludes UV bulb)

Part #	Maximum Pond Size	Filter Model	Pump Model	UV Model	Skid Size	Stocking Code	Ship Weight	List Price
<b>SMF1800</b>	1800 Gallon System	PBF1800	EXP4000	PCU35W	32" x 32"	72944992	109 lbs.	\$3799.99
<b>SMF3600</b>	3600 Gallon System	PBF3600	EXP5500	PCU35W	32" x 32"	63177492	146 lbs	\$4099.99
<b>SMF6000</b>	6000 Gallon System	PBF6000	EXP6500	PCU55W	36" x 36"	73642495	166 lbs.	\$4699.99
<b>SMF10000</b>	10,000 Gallon System	PBF10000	EXP7500	PCU75W	48" x 48"	64494994	230 lbs.	\$5799.99



## Built with EasyPro's Innovation, Quality and Experience!

Each Skid Mounted System is manufactured and pressure tested in our facility before shipping. If one of the systems shown above does not fit your needs, we can custom-build one just for you.

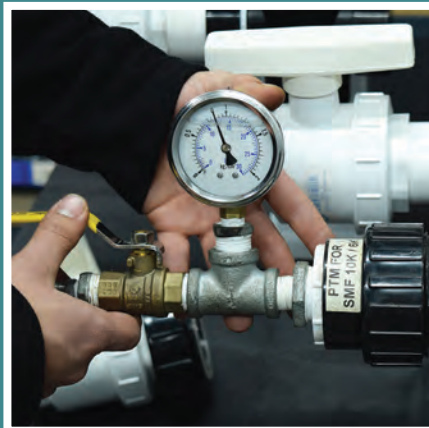
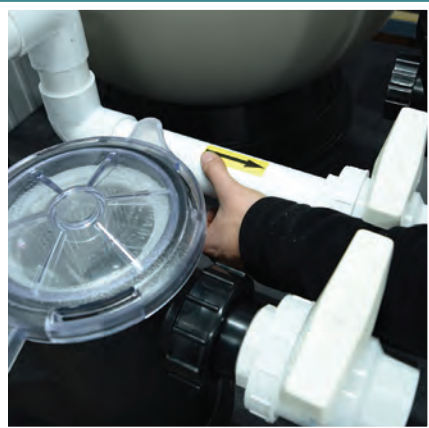





## Solids Filter Material

Save money — cut your own filter pads!

Bulk media that can easily be cut to fit popular brands of skimmers, pressure filters, waterfall filter boxes or pump pre-filters

- Made from long lasting polyester — can be rinsed clean and reused over and over
- Most commonly used as a solids filter material before water enters biological media (page 95)

### PFM4

- 1" coarse density, off white
- Removes medium to large particles
- Ideal for higher flow
- Average life - 2 to 3 years

### PFM5

- 2" coarse density, off white
- Used in waterfall filter boxes
- 56" wide roll for large jobs
- Average life - 2 to 3 years

Part #	Description	Thickness x Width x Length	Small Parcel Shippable	Stocking Code	Ship Weight	List Price
PFM4	Coarse density	1" x 28" x per yard	11 yard max.	519254	4 lbs.*	\$24.09
PFM4B	Coarse density	1" x 28" x 6 yard box	yes	2102671	10 lbs.*	\$128.39
PFM4R	Coarse density	1" x 28" x 40 yard roll	no	5615994	78 lbs.	\$769.99
PFM5	Coarse density	2" x 28" x per yard	6 yard max.	428003	5 lbs.*	\$34.99
PFM5B	Coarse density	2" x 28" x 6 yard box	yes	2149336	17 lbs.*	\$186.69
PFM5R	Coarse density	2" x 28" x 30 yard roll	no	2671992	90 lbs.	\$839.99
PFM5F	Coarse density	2" x 56" x 30 yard roll	no	81303997	105 lbs.	\$1629.99



PFM4R  
PFM5R  
PFM5F

\*Dimensional shipping rate applies



BB05



## Bio-Balls

These plastic Bio-Balls are a great media for use in all types of filters. Approximately 350 sq. ft. of surface area per cubic foot.

- Can be used as a loose media or put in mesh bags (page 96) for easy removal and cleaning
- Will not compact like other soft media, reduces channeling of water
- 1 1/2" in diameter, black in color - approximately 660 pieces per cubic foot



Part #	Description	Stocking Code	Ship Weight	List Price
BB05	Bio-Balls, approx. 200 ct. box w/bag	620248	3 lbs.	\$26.99
BB15	Bio-Balls, one cubic foot	435249	9 lbs	\$46.99
BB35	Bio-Balls, 3.5 cubic feet	7104992	32 lbs.	\$139.99

\*Dimensional shipping rate applies



## Filter Floss Bio-Media

Flat strapping embossed on both sides creating additional surface area for beneficial bacteria to thrive.

- Light weight ribbon type material commonly used in our AquaFalls pond filters
- Each box fills three MB21 mesh bags (below) and contains approximately 6 cubic feet of media
- Save 5% when ordering in case quantities, four per case

Part #	Description	Stocking Code	Ship Weight	List Price
FFM	Filter Floss bio-media, 3000' roll	659998	9 lbs.	\$79.99
FFM2B	MB21 media bag with 1/3 roll filter floss	537976	4 lbs.*	\$49.69

\*Dimensional shipping rate applies



## Bio-Blox Filter Media

An ultra high surface area media, created from a variety of different filter thicknesses and densities EasyPro® grinds this media in-house, allowing us to offer very competitive pricing

- Great low-cost choice for large volume applications
- Approximately 525 square feet of surface area per cubic foot, allowing for maximum filtration in a given area.
- Long lasting material can be washed and reused over and over
- Use mesh media bags to hold Bio-Blox for easier handling (sold separately on page 96)

**Best Value!**



BBM1



BBM2B

Part #	Description	Stocking Code	Ship Weight	List Price
<b>BBM1</b>	Bio-Blox, one cubic foot - box	622491	4 lbs.	\$29.99
<b>BBM2B</b>	Bio-Blox, two cubic feet w/MB21 mesh bag	246494	8 lbs	\$61.99
<b>BBM8</b>	Bio-Blox, eight cu. ft. box	2149997	382 lbs.*	\$199.99

\*Dimensional shipping rate applies



## Ultimate Tube Media

The ideal filtration media in any type of filter! Ultimate Tube Media is a floating media with a higher biofilm surface than other plastic media.

- Round media with multiple internal baffles which create tremendous additional surface area
- Floating media - use in bead filters or other biological pond filters
- 5/8" diameter x 3/8" long tubes
- Approx. 500 square feet of surface area in every cubic foot



UTM1N

Part #	Description	Stocking Code	Ship Weight	List Price
<b>UTM1N</b>	Ultimate Tube Media, one cubic foot	129996	11 lbs.	\$39.99
<b>UTM135</b>	Ultimate Tube Media, 3.5 cubic feet	895992	34 lbs.*	\$127.99

\*Dimensional shipping rate applies



## Filter Brushes

Collect large amounts of debris yet will not restrict water flow even when dirty

- Work well for both solids removal and biological filtration
- Available in 15" or 23" long x 4" diameter. Can be cut down in length if needed.
- 15" used in PSMFB, PS1FB and all PSA skimmers - 23" used in PS2FB skimmers



Part #	Description	Case Quantity	Stocking Code	Ship Weight	List Price
<b>FB15</b>	Filter brush, 15"	12	76293	1 lb.	\$8.99
<b>FB23</b>	Filter brush, 23"	12	49097	2 lbs.	\$12.99





## Matala® Filtration Media

EasyPro® is pleased to offer Matala filter media. This media is the finest biological media available and although it costs a little more — it will outlast all other similar products.

Matala is sold in two sizes of flat sheets:

Half sheets - 39" x 24" - can ship UPS      Full sheets - 39" x 48"

Available in four different densities for various types of filtration

- **Black** Very coarse, open weave — good for high flow applications
- **Green** Coarse, semi-open weave — allows good flow yet filters well
- **Blue** Medium, fairly dense weave — traps a lot of debris, medium flow
- **Gray** Fine, dense weave — lower flow but thorough filtration

All densities are 1½" thick

Part #	Description	Case Quantity	Stocking Code	Ship Weight	List Price
<b>MBK48*</b>	Full sheet black material	5	250393	8 lbs.	\$71.99
<b>MGN48*</b>	Full sheet green material	5	350394	9 lbs.	\$71.99
<b>MBE48*</b>	Full sheet blue material	5	451445	9 lbs.	\$73.49
<b>MGY48*</b>	Full sheet gray material	5	658795	10 lbs.	\$83.99
<b>MBK24**</b>	Half sheet black material	10	625197	4 lbs.	\$35.99
<b>MGN24**</b>	Half sheet green material	10	725478	5 lbs.	\$36.39
<b>MBE24**</b>	Half sheet blue material	10	826738	5 lbs.	\$38.19
<b>MGY24**</b>	Half sheet gray material	10	829391	6 lbs.	\$41.99

\* Flat Full sheets ship motor freight. Full Sheets can be folded in half to ship with dimensional rates. Folding may leave a small crease in media but will not affect filtering. \*\* Half Sheets ship UPS.



For best results mix layers of Matala using a coarse layer first for large solids removal followed by denser layers for fine debris. Due to its unique material design, Matala media is much more rigid than traditional polyester media. This makes it easier to clean but does not allow it to be rolled up like other media.



Easy to cut into custom sizes or shapes!

## Matala® Biological Prefilter

- Use on all brands of mag drive submersible pumps as well as small external pumps to prevent plugging
- Made from durable Matala filter media for years of use
- Can be connected to each other end to end for increased capacity
- Dual filter media (green and blue) for complete mechanical and some biological filtration
- 1", 1¼" and 1½" hose tails included, fitting on filter is 1½" female pipe thread
- Maximum flow rate: 1900 gph on BIO11 and 3400 gph on BIO20

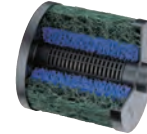
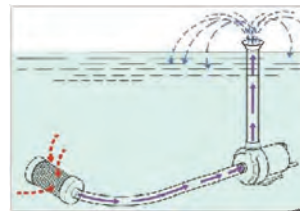

Part #	Description	Case Quantity	Stocking Code	Ship Weight	List Price
<b>BIO11</b>	Prefilter, small - 4" x 8"	18	620295	2 lbs.	\$28.99
<b>BIO20</b>	Prefilter, large - 8" x 8"	8	233596	4 lbs.	\$47.99



MB21

EMB2

Holds all types of media

## Mesh Media Bags

- EMB1, EMB2 and EMB3 are ⅛" mesh and have drawstring with push button release
- MB21 and MB22 are ¼" mesh and have drawstring with push button release
- MB18F is ⅜" fine mesh and has drawstring with push button release

Part #	Description	Dimensions	Case Quantity	Stocking Code	Ship Weight	List Price
<b>EMB1</b>	Mesh media bags, ⅛" mesh	12" x 12"	12	57125	1 lb.	\$9.49
<b>EMB2</b>	Mesh media bags, ⅛" mesh	12" x 18"	12	28996	1 lb.	\$11.99
<b>EMB3</b>	Mesh media bags, ⅛" mesh	18" x 18"	12	311248	1 lb.	\$14.99
<b>MB21</b>	Media bag, ¼" mesh	21" x 30"	12	414993	1 lb.	\$19.99
<b>MB22</b>	Media bag, ¼" mesh	22" x 26"	12	215743	1 lb.	\$20.99



MB Media Bags

## AQUA ULTRAVIOLET **Ultima II Filters**

Ultima II Filters are superior to bead filters because of their patented Bio-Tube media which do not clump together like beads. No need for a blower for backwashing!

- Very easy to backwash — never get your hands wet
- Unique media allows for high flow rates with minimal back pressure
- Bury in ground (up to control head) for easy hiding when used as a pond filter

Patented Bio-Tube Filter media has an extremely high surface area (one cubic foot of media has 750 square feet of surface area) for maximum filtration. This lightweight, non-clogging media is seeded with natural bacteria for quick filter start up after installation.

**All units ship factory direct and will incur a \$20 Aqua UV drop ship fee.**



Part #	† Maximum Pond Size	Maximum Pounds of Fish	Maximum gph Flow	Inlet/Outlet Size	Filter Size Height x Diameter	Stocking Code	Ship Weight	List Price
AA200	20,000	1225	125	2"	48" x 31"	73684128	190 lbs.*	\$5894.59
AA300	30,000	1750	125	2"	53" x 36"	24603341	270 lbs.*	\$7365.35
AA300S**	30,000	1750	340	3"	40" x 49" x 31"	56279506	290 lbs.*	\$10,047.19
AA600S**	60,000	2400	340	3"	46" x 55" x 37"	78913432	345 lbs.*	\$14,261.50



\*Dimensional shipping rate applies \*\* AA300S and AA600S have 3" side mount control heads  
 †Maximum pond size is for water garden applications which typically have a light fish load. Use "Maximum Pounds of Fish" column for aquaculture and fish holding systems where density of fish is much higher.

## AQUA ULTRAVIOLET **Industrial UV**

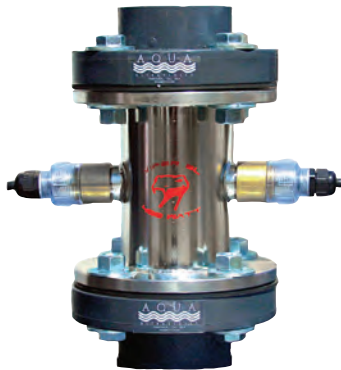

VIP43

- 3" inlet/outlet and stainless steel body
- Includes flow switch to shut off bulb in low flow situations
- 400 watt
- 240 gpm maximum flow
- Service kit includes bulb, seals and sleeve

Part #	Description	Stocking Code	Ship Weight	List Price
VIP43	115v Industrial UV	63598244	38, 14, 30 lbs.	\$5757.19
VIP432	230v Industrial UV	83418327	38, 14, 38 lbs.	\$5469.31
VIP43SK	Service kit	3507459	5 lbs.	\$811.92

**These units ship factory direct and will incur a \$20 Aqua UV drop ship fee.**



## AQUA ULTRAVIOLET **Replacement Parts**

### Bulbs

Part #	Watts	Stocking Code	Ship Weight	List Price
AUB8	8w	264432	1 lb.	\$103.09
AUB15	15w	266174	2 lbs.	\$105.88
AUB25	25w	567886	2 lbs.	\$108.61
AUB40	40w	576378	2 lbs.	\$122.19
AUB57	57w	181425	2 lbs.	\$130.27

### Sleeves

Part #	Watts	Stocking Code	Ship Weight	List Price
AUS8	8w	361124	1 lb.	\$97.80
AUS15	15w	361128	2 lbs.	\$97.80
AUS25	25w	966175	2 lbs.	\$105.88
AUS40	40w	574674	3 lbs.	\$119.47
AUS57	57w	466178	2 lbs.	\$105.88

### Transformers

Part #	Watts	Stocking Code	Ship Weight	List Price
AUT8	8w	6119372	3 lbs.	\$191.00
AUT15	15w	2119371	3 lbs.	\$191.00
AUT25	25w	7135098	3 lbs.	\$216.14
AUT40	40w	7177993	4 lbs.	\$284.78
AUT57	57w	3183812	7 lbs.	\$294.09



EasyPro® offers one of the largest selections of pumps in the country. In addition to the many pages of pumps shown, we have hundreds of additional pumps available. We specialize in high volume pumps and can supply you with virtually any size pump you could ever need. Contact us for all your pumping needs. We are glad to help you size and select the proper pump for your application.



Example: A 3' wide waterfall would need 108 gallons per minute to be 1" thick.

## PRO-TIP

## Selecting The Right Pump

### Volume - Flow Rate



It takes approximately 36 gallons per minute of flow to make a waterfall 1' wide x 1" deep (1" deep water is considered an average depth for residential applications). The first step in determining how much water you need is to multiply the width of the waterfall in feet x 36 = gallons per minute. This helps determine how much volume you need.

Determine how much static head (vertical lift) there is from the surface of the pond to the top of the waterfall. On a small, simple waterfall the vertical lift is all you need, however on large applications you also need to factor in friction loss from the pipe as well as each fitting to get the total dynamic head (TDH). How to calculate friction loss is covered on page 109.

**Static Head + Friction Loss = TDH**

Knowing the water volume needed and the total dynamic head makes selecting a pump much easier. Start by looking at our chart on page 104. This chart lists all of our popular pumps on one page.

In the yellow columns on the right side of the chart — find the column of head closest to your application and follow that column down until you find a pump that delivers the gallons per minute (gpm) you need.

Selecting the correct pump for the job will increase the overall performance of the feature and decrease the frustration of frequent call backs and unhappy customers.

**Unique application? Using an external pump? Have questions?  
Please do not hesitate to call.**

*Improper pump application is the leading cause of pump failure - we want to help you select the best pump for your application.*

When calling, you will be asked for:

1. The flow rate needed (volume)
2. Length of pipe run and diameter of pipe
3. Static head
4. Voltage and phase of power available

### Total Dynamic Head Pressure



### Know Your Application



### Extending Pump Life



**The single most important thing you can do to ensure long pump life, particularly on larger motors...**

The life of any pump is directly related to the operating conditions it works under. One of the most common causes of premature pump failure is **LOW** head. Pumps are designed to work under a certain amount of load. In low head applications, not enough back pressure is put on the pump and it spins too freely. This causes the motors to run hot and shortens their life considerably.

In every plumbing system you should incorporate a valve somewhere in the discharge line. This valve can then be closed part way to simulate back pressure if not enough natural pressure is created.

How do you know if your pump has enough back pressure? The best way to test this is through the electrical draw of the motor. Every pump has a label on it which shows the amp draw of the motor. If you have too little back pressure then the amp draw will be high. As you close the valve on the discharge line and increase pressure the amp draw will go down.

By using a simple device like the "Kill-A-Watt" meter for 115 volt applications you can easily dial-in the amp draw of the motor. When you are done, the pump's electric draw should be equal to or less than the amp draw listed on the pump label. You are then within the safe operating range of the motor. For 230 volt motors you can have your electrician test the running amp draw for you or purchase a 230 volt amp meter from a local electrical supply store. Proper plumbing and adequate electrical supply are also critical in the life of a pump. Please visit our web site for more information.

## Tranquil Décor Mag Drive Pumps

Perfect submersible pump for fountains and bubbler features

- Compact, energy efficient design
- Oil free, environmentally safe
- Built in adjustable flow control
- 115 volts – 60 Hz
- One year warranty
- MP295, MP425, MP575 have 1/2" female threaded outlet
- MP1000 has 3/4" female threaded outlet



Part #	Maximum gph	Watts	Barb Outlet Sizes	Cord Length	Maximum Head	Dimensions (H x W x D)	Case Quantity	Stocking Code	Ship Weight	List Price
<b>MP125</b>	125	5	1/2"	6'	28"	2.0" x 1.6" x 2.3"	6	813497	2 lbs.	\$17.99
<b>MP230</b>	230	13	1/2"	13'	60"	2.6" x 2.0" x 3.0"	6	522498	2 lbs.	\$29.99
<b>MP295</b>	295	17	1/2", 5/8", 3/4"	13'	60"	3.0" x 2.2" x 3.5"	6	241991	3 lbs.	\$55.99
<b>MP425</b>	425	27	1/2", 5/8", 3/4"	13'	98"	3.3" x 2.7" x 4.0"	4	348745	3 lbs.	\$64.99
<b>MP575</b>	575	44	1/2", 5/8", 3/4"	13'	98"	3.8" x 2.9" x 4.4"	4	659998	3 lbs.	\$79.99
<b>MP1000</b>	1000	93	1/2", 3/4", 1"	13'	108"	4.5" x 3.3" x 5.2"	4	789992	4 lbs.	\$119.99



## Pump Pro-Tectors

Protect against plugging by creating a large surface area around the pump

- Designed to fit all brands of small pumps
- Has a polyester filter media pad inside of a nylon mesh bag
- Drawstring top with push button release keeps the top closed around the pump yet makes for easy pump removal
- **PP8** has an 8" diameter and 1" thick sidewalls allowing pumps up to 6" diameter
- **PP12** has a 12" diameter and has 2" thick sidewalls allowing pumps up to 8" diameter



Part #	Maximum gph Flow	Case Quantity	Stocking Code	Ship Weight	List Price
<b>PP8</b>	1250	6	323625	2 lbs.	\$31.49
<b>PP12</b>	2550	4	433741	3 lbs.	\$44.99



## Three-Way Valve

The versatile valve splits the water flow so you can operate two features from a single pump.

- 1/4", 1/2", 2" inlet step barb
- 1", 1/4", 1/2" outlet step barb



Part #	Stocking Code	Ship Weight	List Price
<b>ECM3V</b>	723999	2 lbs.	\$29.99





## EasyPro® Mag Drive Pumps stand out from the crowd in features, benefits and durability.

With sixteen models ranging from 200 gph to 9460 gph, EasyPro® offers a model for nearly every application. For low head applications, Mag Drive pumps are unbeatable and with few moving parts, their reliability is unsurpassed.

### Pond & Water Feature Pumps

The industry standard for smaller water features

- Washable foam prefilter
- Free fountain nozzles with every pump. See chart below for details and scan the QR code to see the nozzles in action.
- **Three year warranty**



Scan Code for Video

See the fountain nozzles in action!



Part #	Max. Flow	Cord Length	Threaded Outlet	Case Qty.	Stocking Code	Ship Weight	List Price
EP200	200 gph	12'	1/2"	12	533748	4 lbs.	\$44.99
EP400	400 gph	12'	1/2"	12	759991	4 lbs.	\$79.99
EP600	600 gph	16'	1/2"	6	280993	6 lbs.	\$107.99
EP850	850 gph	16'	3/4"	6	488344	7 lbs.	\$117.79
EP1050	1050 gph	16'	3/4"	6	8107922	7 lbs.	\$143.89
EP1350	1350 gph	20'	3/4"	4	4142498	8 lbs.	\$189.99



### Pond & Water Feature Pumps

The industry standard for medium water features

- These larger pumps have screened inlet but no foam prefilter
- **Three year warranty**



EP3200N



Part #	Max. Flow	Cord Length	Threaded Outlet	Case Qty.	Stocking Code	Ship Weight	List Price
EP1750	1750 gph	20'	3/4"	4	2175492	8 lbs.	\$233.99
EP2200	2200 gph	26'	1"	4	3198524	11 lbs.	\$264.69
EP3200N	3200 gph	26'	1"	4	4223493	15 lbs.	\$297.99



### MAG DRIVE PUMP PERFORMANCE DATA

Model	Watts	Gallons per hour (gph) flow at feet of head						Max. Lift	Fountain Nozzles	FEATURE SIZE
		0'	3'	6'	9'	12'	15'			
EP200	17	200	160	48	-	-	-	7'	volcano, waterbell	XS
EP400	20	400	292	204	61	-	-	10'	volcano, waterbell	S
EP600	35	600	452	310	93	-	-	12'	volcano, waterbell, double volcano	S
EP850	60	850	637	439	131	-	-	12'	volcano, waterbell, double volcano	S
EP1050	70	1050	892	740	518	232	-	13.5'	volcano, waterbell, double volcano	S/M
EP1350	90	1350	1215	1032	722	467	-	15'	volcano, double volcano, waterbell, foaming jet	M
EP1750	130	1750	1530	1150	915	782	463	20'	-	M
EP2200	190	2200	1848	1478	1108	819	573	20'	-	L
EP3200N	195	3200	2720	2284	1598	878	474	20'	-	L



SINCE 1970

# EasyPro Pumps *Only Nature Does It Better*



## Pond & Waterfall Pumps

Asynchronous, mag drive pumps. Where power and efficiency meet!

- Seven models for all larger features
- Very quiet and energy efficient
- Fully submersible
- No oil — fish safe!
- Can be run vertically or horizontally
- Removable prefilter screen
- Epoxy filled 115v motors
- Two year warranty



EPA6500

Part #	Max. Flow	Cord Length	Threaded Outlet	Case Qty.	Stocking Code	Ship Weight	List Price
EPA1900	1922 gph	20'	1"	2	2191245	8 lbs.	\$254.99
EPA2500	2510 gph	20'	1½"	2	5206246	9 lbs.	\$274.99
EPA3100	3120 gph	20'	1½"	2	8232499	9 lbs.	\$309.99
EPA4500	4620 gph	30'	2"	2	1284997	18 lbs.	\$379.99
EPA5500	5360 gph	30'	2"	2	8337497	18 lbs.	\$449.99
EPA6500	6760 gph	30'	2"	2	6394495	19 lbs.	\$525.99
EPA9500	9460 gph	30'	2"	2	3524994	20 lbs.	\$699.99



### HIGH VOLUME MAG DRIVE PUMP PERFORMANCE DATA

Model	Watts	Gallons per minute (gpm) flow at feet of head									Max. Lift	FEATURE SIZE
		0'	4'	8'	12'	16'	20'	24'	28'	32'		
EPA1900	175	32	25	15	3	-	-	-	-	-	13'	L
EPA2500	200	42	34	25	16	5	-	-	-	-	18'	L
EPA3100	210	52	44	34	24	13	-	-	-	-	20'	L
EPA4500	400	77	71	65	57	48	37	17	-	-	26'	XL
EPA5500	420	89	81	72	63	53	41	23	-	-	26'	XL
EPA6500	490	113	102	90	78	63	44	18	-	-	26'	XL
EPA9500	710	158	133	112	93	75	58	39	17	-	30'	XL

#### Replacement Impellers - EP Pumps

Part #	Fits Pump	Stocking Code	List Price
EP120I	EP120	86749	\$8.99
EP200I	EP200	96748	\$8.99
EP400I	EP400	711476	\$15.29
EP600I	EP600	612595	\$16.79
EP850I	EP850	314248	\$18.99
EP1050I	EP1050	320545	\$27.39
EP1350I	EP1350	627825	\$37.09
EP1750I	EP1750	628043	\$37.39
EP2200I	EP2200	233141	\$44.19
EP3200I	EP3200	845379	\$60.49
EP3200IN	EP3200N	945378	\$60.49

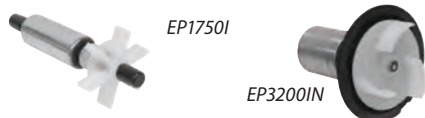

#### Replacement Impellers - EPA Pumps

Part #	Fits Pump	Stocking Code	List Price
EPA1900I	EPA1900	326242	\$34.99
EPA2500I	EPA2500	229241	\$38.99
EPA3100I	EPA3100	932241	\$42.99
EPA4500I	EP4700N/EPA4500	852498	\$69.99
EPA5500I	EPA5500	759997	\$79.99
EPA6500I	EP6700N/EPA6500	364721	\$86.29
EPA9500I	EP9700/EPA9500	869528	\$92.69



#### Replacement Foam Filters - EP Pumps

Part #	Fits Pump	Stocking Code	List Price
EP120F	EP120	65247	\$6.99
EP200F	EP200	45998	\$7.99
EP400F	EP400	45995	\$7.99
EP600F	EP600	65997	\$7.99
EP850F	EP850	86749	\$8.99
EP1050F	EP1050	46741	\$8.99
EP1350F	EP1350	86748	\$8.99







## Eco-Clear Submersible Pond Pumps

**3 Year Warranty**

Our newest line of submersible mag drive pumps offers maximum power AND energy efficiency.

- Permanent magnet motor for high efficiency and continuous duty
- Epoxy sealed motor - no oil to leak out! Safe for fish.
- Ceramic impeller provides high wear resistance and long life — designed for passing debris up to 3/8" diameter
- Adjustable direction outlet includes 1", 1 1/4" or 1 1/2" step barb fitting
- Available as a kit with EasyPro® Eco-Clear Pressurized Filters. See page 89.
- **Variable flow model EPS4900VF** available with external flow control module
- 30' power cord

Buy more and save! Save 5% when you buy a case of 4.



**Powerful Mag Drive Pump**



**Protective Housing**



**Convenient Handle**



**Multi-Step Barb Fittings**



**Adjustable Outlet**



**2" Outlet for Higher Flows**



**Flow Control (EPS4900VF Model)**

### ECO-CLEAR PUMP PERFORMANCE DATA\*

Model	Max Watts	Gallons per hour (gph) flow at feet of head										Max Lift	COMPATIBLE ECO-CLEAR FILTER
		0'	3'	6'	9'	12'	15'	18'	21'	24'			
EPS1300	55	1400	1125	710	430	150	-	-	-	-	14.5'	EC1300 / EC1300U	
EPS2500	87	2480	1680	1140	815	449	185	-	-	-	16'	EC2600 / EC2600U	
EPS3700	150	3680	2900	2310	1815	1390	875	180	-	-	19'	EC3900 / EC3900U	
EPS4900	190	4850	4090	3215	2425	1800	1400	832	195	-	22'	-	
EPS4900VF	190	4850	4090	3215	2425	1800	1400	832	195	-	22'	-	

Part #	Watts	Max. Flow	Max. Lift	Case Quantity	Stocking Code	Ship Weight	List Price
EPS1300	55	1400 gph	14.5'	4	2157498	10 lbs.	\$209.99
EPS2500	87	2480 gph	16'	4	8168744	10 lbs.	\$224.99
EPS3700	150	3680 gph	19'	4	6217493	11 lbs.	\$289.99
EPS4900	190	4850 gph	22'	4	6239991	11 lbs.	\$319.99
EPS4900VF	190	4850 gph	22'	4	7299995	13 lbs.	\$399.99



### Replacement Impellers

Part #	Fits Pump	Stocking Code	List Price
EPS1300I	Fits pump EPS1300	733747	\$44.99
EPS2500I	Fits pump EPS2500	835999	\$47.99
EPS3700I	Fits pump EPS3700	650241	\$66.99
EPS4900I	Fits pumps EPS4900 and EPS4900VF	452493	\$69.99



TLS1850

## Spirit™ Pond & Waterfall Pumps

Waterfall pumps with Italian engineering — reliable and energy efficient with a unique design

- Triple sealed, 115 volt motors for maximum life span
- Oil-less design is fish and plant safe
- 16' power cords
- Can be run vertically or horizontally for compact applications
- 1 1/4" female threaded outlet, 1 1/4" x 1 1/2" threaded elbow included
- Energy efficient direct drive pump



Can be run in vertical or horizontal applications

**An EasyPro® Favorite!**

**18 Month Warranty**

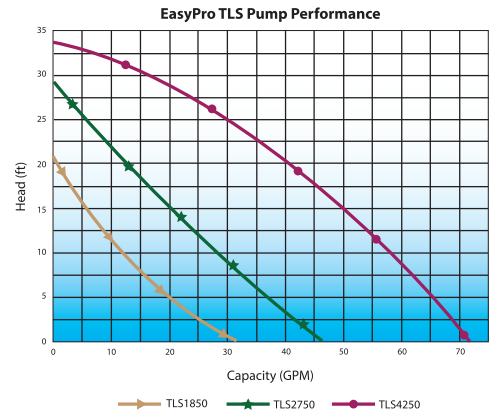

Part #	Maximum gph	Watts	hp	Amps	Maximum Head	Dimensions (H x W x D)	Stocking Code	Ship Weight	List Price
TLS1850	1850 gph	260	1/4	2.4	21'	10 1/2" x 5 1/2" x 6"	6170994	11 lbs.	\$227.99
TLS2750	2750 gph	370	1/3	3.4	29'	10 1/2" x 5 1/2" x 6"	5202493	12 lbs.	\$269.99
TLS4250	4250 gph	820	1/2	7.6	33'	12" x 5 1/2" x 6"	7269998	16 lbs.	\$359.99



ETP05N



## Submersible Trash Pumps

This submersible trash pump handles sand, solids, leaves, algae and other debris up to 3/8" x 1" in size

- Great pond clean out pumps
- 115v motors with 20' power cord and 2" fpt discharge

### Clean-out Package

- Includes 25' or 50' of roll-up hose and premium cam-lock fittings to easily connect hose to pump

**2 Year Warranty**



Part #	hp	Amps	gpm @ feet of head						Stocking Code	Ship Weight	List Price
			5'	10'	15'	20'	25'	30'			
ETP05N	1/2 hp	6.6	57	53	46	39	32	23	6464997	27 lbs.	\$619.99
ETP10N	1 hp	11.5	95	87	78	72	63	57	3554997	34 lbs.	\$739.99
PCH25	25' roll-up hose for pond cleanouts								474999	7 lbs.	\$99.99
PCH50	50' roll-up hose for pond cleanouts								2123744	12 lbs.	\$164.99



## Our Best Selling Pumps of All Time!

# TH SERIES™ Pumps

## Stainless Steel Pumps

Energy efficient, long lasting — great pumps for waterfalls and streams

The "TH Series" of pumps has proven to be a great choice for ponds, waterfalls, fountains and similar applications. Thousands of these pumps are in use throughout North America in a wide variety of continuous duty applications. Compact design is ideal for use in skimmers. One of the industry's best selling pumps.

- Rugged motor — designed for long life, continuous duty operation; motor housing is corrosion-resistant stainless steel
- Low maintenance — pump casing is made from abrasion-resistant, fiber reinforced plastic for maximum life
- Vortex design prevents clogging
- Built-in overload and overheat motor protection
- 2" female threaded outlet
- 20' power cords



**2 Year  
Warranty**



Life Style Creations (MN)

Optional bottom screen available!

Refer to page 98 for tips to selecting the right pump for your job

Part #	gph	hp	Amps/Volts	gpm @ feet of head						Maximum Head	Stocking Code	Ship Weight	List Price
				0'	5'	10'	15'	20'	25'				
TH150	3100 gph	1/4	2.6-3.1/115	52	46	35	23	10	-	23'	2389993	19 lbs.	\$519.99
TH1502	3100 gph	1/4	1.3-1.5/230	52	46	35	23	10	-	23'	4389995	19 lbs.	\$519.99
TH250	4100 gph	1/3	3.0-4.2/115	68	65	54	43	30	15	30'	6468747	22 lbs.	\$624.99
TH2502	4100 gph	1/3	1.5-2.1/230	68	65	54	43	30	15	30'	8468741	22 lbs.	\$624.99
TH400	5100 gph	1/2	3.7-6.0/115	85	83	73	60	46	34	36'	2536243	25 lbs.	\$714.99
TH4002	5100 gph	1/2	1.8-3.0/230	85	83	73	60	46	34	36'	3536244	25 lbs.	\$714.99
TH750	6000 gph	1	6.0-9.9/115	100	98	91	83	73	62	46'	6614997	28 lbs.	\$819.99
TH7502	6000 gph	1	3.0-4.9/230	100	98	91	83	73	62	46'	8614998	28 lbs.	\$819.99
THPS	Bottom screen for all sizes of TH pumps (fits mid 2009 models & newer)									—	320243	1 lb.	\$26.99



## 115 Volt TH Pumps with 50' or 100' Cords

### TH Pumps with 50' cord

Part #	Stocking Code	Ship Weight	List Price
TH150-50	6449993	22 lbs.	\$599.99
TH250-50	2524994	25 lbs.	\$699.99
TH400-50	8569991	28 lbs.	\$759.99
TH750-50	7697492	31 lbs.	\$929.99

### TH Pumps with 100' cord

Part #	Stocking Code	Ship Weight	List Price
TH150-100	3592492	28 lbs.	\$789.99
TH250-100	4652492	31 lbs.	\$869.99
TH400-100	8712492	34 lbs.	\$949.99
TH750-100	6839991	39 lbs.	\$1119.99





# EasyPro Pumps Only Nature Does It Better

## TM SERIES™ Low Head Stainless Steel Pumps

Perfect for streams and waterfalls

- Ideal for low to medium head waterfalls
- Up to 17,500 gph flow
- 3" outlets with 30' power cords and thermal overload protection
- Top quality Japanese double mechanical seals for maximum life
- High volume in a compact design allows for use in large skimmers

**2 Year  
Warranty**



Part #	hp	Maximum Amps	Voltage	Maximum gph	Maximum gpm	Power Cord	Outlet Size	Stocking Code	Ship Weight	List Price
TM9500	1	10.9	115	9500	158	30'	3"	7839991	54 lbs.	\$1119.99
TM9502	1	5.5	230	9500	158	30'	3"	3839992	54 lbs.	\$1119.99
TM13500	1.5	12	115	13500	225	30'	3"	61004996	63 lbs.	\$1339.99
TM13502	1.5	6	230	13500	225	30'	3"	21004992	63 lbs.	\$1339.99
TM17500	2	10	230	17500	290	30'	3"	41244998	74 lbs.	\$1659.99



Smalls Landscaping (IN)

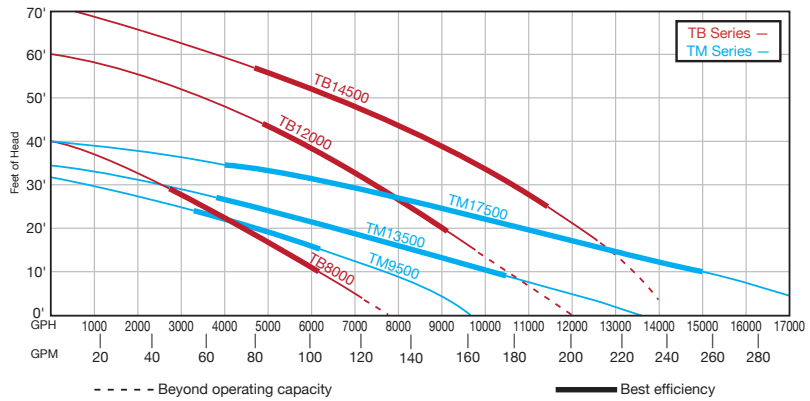

## TB SERIES™ High Head Stainless Steel Pumps

The best choice for water features above 20'

- 3" outlets with 20' power cords and thermal overload protection
- Top quality Japanese double mechanical seals — over 100,000 hour life expectancy
- 230 volt (1 hp available in 230v or 115v)
- Designed for use with higher head pressure
- Applications: A **minimum** of 20' head pressure required for TB12000 and TB14500, use ball valve to create back pressure if system has less than 20' head pressure

**2 Year  
Warranty**



Part #	hp	Maximum Amps	Voltage	Maximum gph	Maximum gpm	Power Cord	Outlet Size	Stocking Code	Ship Weight	List Price
TB8000	1	11	115	8000	133	20'	3"	3674995	43 lbs.	\$899.99
TB8002	1	5.5	230	8000	133	20'	3"	6674998	43 lbs.	\$899.99
TB12000	2	9.7	230	12000	200	20'	3"	91079994	68 lbs.	\$1439.99
TB14500	3	14.5	230	14500	240	20'	3"	31199991	74 lbs.	\$1599.99





## Matala® Horizontal Skimmer Pumps

Horizontal design allows use in shallow water applications without overheating



- Operates in horizontal or vertical position
- Vortex style intake reduces plugging
- Removable inlet screen prevents large objects from plugging pump
- Continuous duty rated motors
- Energy efficient design reduces operating costs
- 115v motor with 2" outlets and 20' power cord

**2 Year Warranty**



Part #	hp	Maximum gph	Maximum Amps	gpm @ feet of head						Max. Head	Stocking Code	Ship Weight	List Price	
				0'	5'	10'	15'	20'	25'					30'
MHP32	1/5	3200 gph	2.8	54	48	34	14	-	-	-	19"	4371997	20 lbs.	\$479.99
MHP39	1/3	3900 gph	3.2	64	60	46	24	2	-	-	23'	6391374	20 lbs.	\$504.99
MHP47	1/2	4700 gph	5.3	78	71	59	45	30	11	-	30'	8526992	27 lbs.	\$679.99
MHP56	1	5600 gph	7.3	93	91	90	84	68	51	29	37'	2751745	30 lbs.	\$969.99

## High Volume Submersible Pumps

These heavy duty, cast iron pumps are an economical choice for waterfalls. While these pumps are not as long lasting as Munro and EasyPro® Pumps, the high flow and low cost make them a popular choice for large waterfalls. They are the largest 115v submersible pumps we offer.

WQ1502



- All pumps available in 115v or 230v
- 30' power cords
- 3" discharge
- One year warranty

**One Year Warranty**



Part #	hp	Volts	Amps	gpm @ feet of head						Maximum Head	Discharge	Stocking Code	Ship Weight	List Price
				5'	10'	15'	20'	25'	30'					
WQ75	3/4	115	11	178	152	120	60	-	-	23'	3"	3599772	100 lbs.	\$799.69
WQ752	3/4	230	5.5	178	152	120	60	-	-	23'	3"	4599773	100 lbs.	\$799.69
WQ100	1	115	13	195	176	150	66	17	-	26'	3"	5654298	105 lbs.	\$872.39
WQ1002	1	230	6.5	195	176	150	66	17	-	26'	3"	7654296	105 lbs.	\$872.39
WQ150	1.5	115	16	285	245	180	132	65	40	32'	3"	2707541	115 lbs.	\$943.39
WQ1502	1.5	230	8	285	245	180	132	65	40	32'	3"	3707548	115 lbs.	\$943.39

## Inline Flow Meter

This inline flow meter allows for accurate and reliable flow rate measurement without sticking floats or paddle wheels.

- Great for filter systems and UVs, 95-98% accuracy
- Can be installed right next to tees or elbows in any position
- 2" model has integrated check valve
- 2" body is CPVC, 3" and 4" body are PVC
- Fits schedule 40 or 80 pipe

**5 Year Warranty!**



Part #	Description	gpm	Stocking Code	Ship Weight	List Price
FMV20	2" Flow meter/check valve	10-110	8191994	2 lbs.	\$255.99
FMV30	3" Flow meter	90-220	7457498	4 lbs.	\$609.99
FMV40	4" Flow meter	160-300	3509996	6 lbs.	\$679.99



FMV20



SINCE 1970

# Extreme Waterfall Pumps

## MUNRO Pumps

Industry leading performance, value & reliability

- Stainless steel pumps designed to run for years, internal water flow dissipates heat quickly allowing for longer life span
- High efficiency motors pump more water using less energy than most competitors
- 1/2 and 1 hp units are low head, high volume pumps — do not restrict piping or valve back these models
- 2 hp and larger are medium head pumps and can be valved as needed for desired flow
- 24' power cords on 2-5 hp, 30' power cords on 1/2 and 1 hp models

**Install vertically or horizontally!**



Part #	hp	Amps @ 230 Volts	Outlet Diameter	gpm @ feet of head						Maximum Head	Stocking Code	Ship Weight	List Price
				15'	20'	30'	40'	50'	60'				
MRP20	2	9	3"	175	155	125	89	48	-	59'	51837497	95 lbs.	\$2449.99
MRP30**	3	13.4	4"	300	276	224	157	100	40	63'	81949992	103 lbs.	\$2599.99
MRP50**	5*	12.8	4"	360	344	291	238	181	125	84'	42249991	103 lbs.	\$2999.99



*Recommended operation in shaded area*

*\*5 hp is 230v, 3 phase power only*

*\*\*No built-in thermal protection. Fuse panel supplied locally and installed by licensed electrician is recommended.*

*\*\*\* Due to extreme volatility in the market, pumps are priced at the time of sale. Please inquire.*

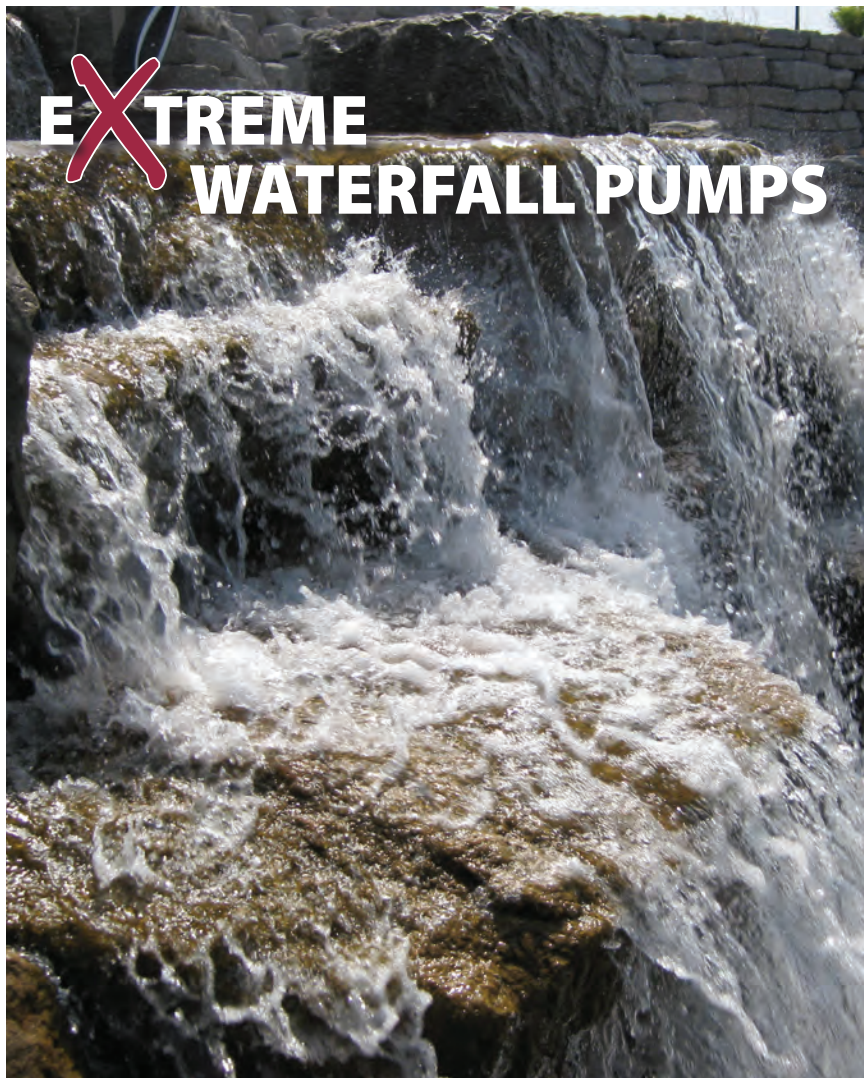

Triangle Associates, Inc. (MI)

**Contact us and we'll help you select the best large pump for your job!**

**EASYPRO.COM**







## Pump Selection Simplified

As described on page 94, selecting a pump involves 1) determine the flow needed: multiply width (in feet) x 36 gpm = flow needed in gpm, and 2) determine the head pressure in feet (total dynamic head, see page 105)

To find a pump, go to the yellow box on the right side of the chart. Find the feet of head column that is closest to your application (always round up to next column). Scroll down that column looking for a pump that provides the gpm you determined you needed in step 1. If multiple pumps fit your application you can compare cost to operate, outlet size, etc. to finalize your selection.

### Submersible Pumps

Flow Rates (gpm) @ feet of head

Part#	Pg #	Hp	Amps @	Volts	Cost for 24 hrs*	Outlet Size	Cord Length	Dimension Diameter	Height	5'	10'	15'	20'	25'	30'	Max. Head
TLS1850	103	1/4	2.4	115	60¢	1.5"	16'	6"	10.5"	20	12	6	1	-	-	21'
TLS2750	103	1/3	3.4	115	84¢	1.5"	16'	6"	10.5"	36	28	20	13	6	-	29'
TLS4250	103	1/2	7.6	115	\$1.77	1.5"	16'	6"	12"	65	58	50	41	30	16	33'
EPA4500	101	N/R	3.4	115	\$0.86	2"	30'	13"	8"	70	61	51	37	9	-	26'
EPA5500	101	N/R	3.6	115	\$0.91	2"	30'	13"	8"	78	67	55	41	14	-	26'
EPA6500	101	N/R	4.2	115	\$1.06	2"	30'	13"	8"	99	84	67	44	11	-	26'
EPA9500	101	N/R	6.1	115	\$1.53	2"	30'	13"	8"	128	103	79	58	33	-	30'
TH150	104	1/4	2.6-3.1	115	72¢	2"	20'	10"	15"	46	35	23	10	-	-	23'
TH250	104	1/3	3.0-4.2	115	99¢	2"	20'	10"	15"	65	54	43	30	15	-	30'
TH400	104	1/2	3.7-6.0	115	\$1.39	2"	20'	10"	17.5"	83	73	60	46	34	20	36'
TH750	104	1	6.0-9.9	115	\$2.36	2"	20'	10"	17.5"	98	91	83	73	62	49	46'
TM9500	105	1	10.9	115	\$2.70	3"	30'	12"	19.5"	142	127	108	81	50	16	31'
TM13500	105	1.5	12	115	\$2.98	3"	30'	12"	21"	191	166	141	106	76	43	34'
TM17500	105	2	10	230	\$4.96	3"	30'	12"	21"	275	250	215	183	147	108	40'
TB8000	105	1	11	115	\$2.73	3"	20'	11"	18"	116	101	90	73	58	41	40'
TB12000	105	2	9.7	230	\$4.81	3"	20'	12"	21"	-	-	165	150	136	123	60'
TB14500	105	3	14.5	230	\$7.20	3"	20'	12"	22.5"	-	-	211	203	191	178	72'

### External Low Head Pumps

Flow Rates (gpm) @ feet of head

Part#	Pg #	Amps	Volts	Cost - 24 hrs*	Outlet Size	Cord Length	5'	10'	15'	20'	25'	30'	Max. Head
EX3600	112	1.4	115	\$0.34	1.5"	8'	52	34	-	-	-	-	12'
EX4500	112	2.7	115	\$0.67	1.5"	8'	67	56	41	15	-	-	21'
EX6100	112	3.1	115	\$0.77	1.5"	8'	92	79	65	40	-	-	23'
EX8800	112	4.4	115	\$0.99	2"	8'	120	103	84	48	-	-	22'
EXP4000	113	1.96	115	\$0.42	2"	8'	59	44	27	-	-	-	17'
EXP5500	113	3.06	115	\$0.76	2"	8'	88	75	28	34	-	-	23'
EXP6500	113	4.00	115	\$0.97	2"	8'	106	91	75	56	-	-	25'
EXP7500	113	5.42	115	\$1.30	2"	8'	-	118	98	75	-	-	26'

### External High Head Pumps

Flow Rates (gpm) @ feet of head

Part#	Pg #	Amps	Volts	Cost - 24 hrs*	Outlet Size	Cord Length	10'	20'	30'	40'	50'	60'	70'	Max. Head
GV75S	111	8.8	115	\$2.19	1.5"	6'	71	65	56	42	21	2	-	60'
GV100S	111	12	115	\$2.48	1.5"	6'	89	85	77	66	52	30	-	68'
GV100	111	12	115	\$2.98	1.5"	6'	117	106	86	50	-	-	-	47'
GV150	111	16	115	\$3.97	1.5"	6'	140	129	116	96	37	-	-	58'
EX8500	112	5.4	230	\$2.68	1.5"	8'	-	116	100	80	51	-	-	55'
EX11000	112	8.6	230	\$4.27	1.5"	8'	-	-	143	125	106	80	33	72'
EX11200	112	9.6	230	\$4.77	2"	8'	-	-	-	138	122	102	75	80'
EX13200	112	11.5	230	\$5.71	2"	8'	-	-	-	175	150	141	117	80'
EXP6500HP	113	4.22	230	\$2.12	2"	8'	104	90	76	57	25	-	-	54'
EXP9500HP	113	8.31	230	\$4.10	2"	n/a	152	146	133	119	104	88	67	83'
PCA75	113	11	115	\$2.44	3"	6'	161	129	90	-	-	-	-	39'
PCA150	113	9.2	230	\$4.19	3"	n/a	226	195	163	113	-	-	-	48'
PCA300	113	13.4	230	\$6.70	3"	n/a	305	276	236	196	145	-	-	58'
PCA500	113	17.6	230	\$8.64	3"	n/a	-	312	282	246	202	140	-	65'

### Swim-Rated Pumps

Flow Rates (gpm) @ feet of head

Part#	Pg #	Amps	Volts	Cost - 24 hrs*	Outlet Size	Cord Length	5'	10'	15'	20'	25'	30'	Max. Head
SPVS165	114	10.83	115	\$3.23	3"	-	204	190	176	160	145	124	42'
SPVS270	114	9.7	230	\$6.63	3"	-	-	268	260	245	230	215	57'
SPHE05	114	9.0	115	\$2.25	4"	-	265	205	140	60	-	-	23'
SPHP40	114	19.4	230	\$9.53	4"	-	-	250	248	245	240	235	95'
SPHF50	114	23.0	230	\$11.29	4"	-	-	-	-	445	425	395	74'

\*Calculated at .09¢ per kilowatt hour, actual costs may vary, for comparison purposes only

## PRO-TIP PVC Pipe: Friction Loss (in feet of head) per 100' of Pipe

Feet of head is typically measured in terms of vertical lift. However, the diameter and length of pipe can have a significant effect on the performance of the pump as well, especially if the pipe diameter is too small.

**Total Dynamic Head** is the feet of head (lift) added to the friction loss created by the pipe. To determine the Total Dynamic Head you would add the feet of head with the friction loss. The chart below lists the feet of head equivalent created by flow and pipe diameter.

FLOW		PIPE DIAMETER									
gpm	gph	1"	1.25"	1.5"	2"	3"	4"	6"	8"	10"	
20	1,200	21.75	5.59	2.61	0.76	0.11					
30	1,800		11.85	5.53	1.62	0.23					
40	2,400		20.18	9.43	2.75	0.40	0.12				
50	3,000			10.51	4.25	0.66	0.17				
60	3,600			19.98	5.84	0.85	0.25				
70	4,200				7.76	1.13	0.33				
80	4,800				9.94	1.44	0.41				
90	5,400				12.37	1.80	0.52				
100	6,000				15.03	2.18	0.63	0.08			
125	7,500					3.31	0.95	0.13			
150	9,000					4.63	1.33	0.18			
175	10,500					6.16	1.78	0.23			
200	12,000					7.88	2.07	0.30			
250	15,000					11.93	3.16	0.45	0.12		
300	18,000						4.45	0.63	0.17		
350	21,000						5.87	0.84	0.22		
400	24,000						7.52	1.08	0.28		
500	30,000							1.66	0.42	0.14	
600	36,000							2.35	0.59	0.19	
700	42,000							3.65	0.79	0.26	
800	48,000								1.02	0.33	
900	54,000								1.27	0.41	
1000	60,000								2.15	0.50	
1250	75,000								2.20	0.73	
1500	90,000								3.07	1.01	

## PIPE COMPARISON

Many people mistakenly think that there isn't much difference between (for example): 1½" and 2" pipe or between 3" and 4" pipe.

The chart on the right shows how many square inches of surface area is on the inside of the flexible PVC pipe.

Pipe Size (Diameter)	Square Inches of Surface Area
0.50"	0.20
0.75"	0.44
1"	0.79
1.25"	1.23
1.5"	1.77
2"	3.14
3"	7.07
4"	12.57
6"	28.27
8"	50.26



**There is almost 80% more space between 1.5" and 2" pipe.**

This shows that using the correct size pipe is important to the output of your pump.

**QUESTIONS?**  
Give one of our technical advisors a call and we'll walk you through it!

## EXAMPLE

### FRICITION LOSS CALCULATION

This example shows 2" pipe being used with the waterfall at 6' high and 50' away from the pump. There is 80 gpm (4,800 gph) of water being pumped.

According to the chart above, 80 gpm in 100' of 2" pipe creates 9.94" of head. Since this example shows 50' of pipe being used, we would divide 9.94 by 2, which equals 4.97" of head from friction loss.

$$\begin{aligned}
 &6' \text{ Vertical Lift} \\
 &+ \\
 &4.97' \text{ Friction Loss} \\
 &= \\
 &10.97' \text{ Total Dynamic Head}
 \end{aligned}$$

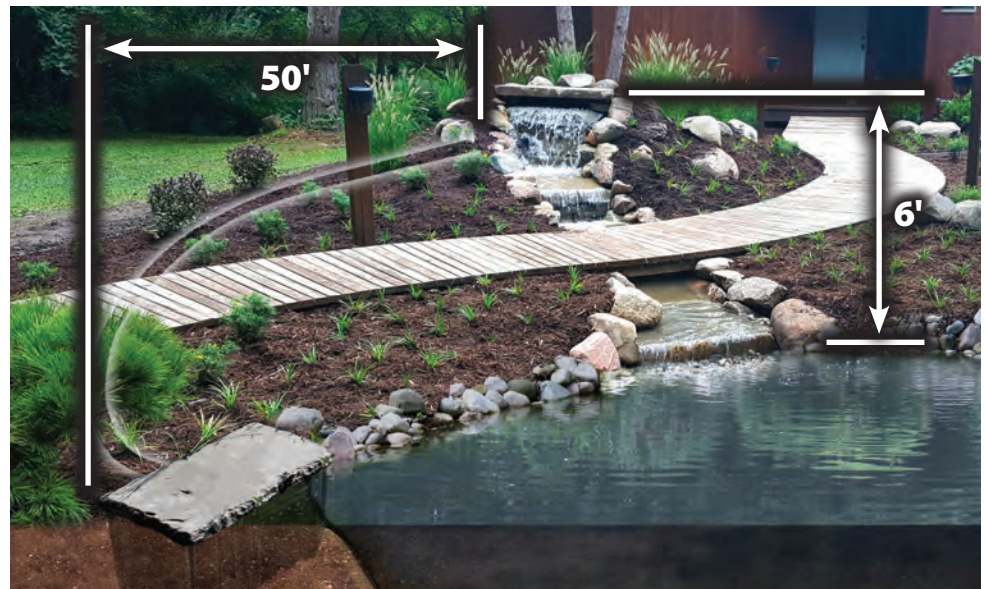



## External Pumps

EasyPro® offers a variety of non-priming and self-priming external pumps. External pumps offer several advantages over submersible pumps, including reduced energy costs and longer average life span.

**Non-priming pumps** are best in flooded suction applications. This means the pump sits below the water level it is pumping. Examples would be alongside of a fish tank or in a pump chamber buried alongside of a pond. These pumps can sit above the water level, however, a check valve must be used on the end of the suction line to keep the pump primed.

**Self-priming pumps** have the capability of purging some air from the suction line and priming themselves (after filling the pump with water the first time). These pumps can sit above the water level without a check valve in the suction line, however, using a check valve speeds up the priming process and ensures a quick flow when the pump is plugged in.

See the **pump comparison chart (page 104)** of our most popular external pumps. This chart will help you select the pump best suited for your application. Start by finding the feet of head column on the right side of the chart. Look down the numbers under the feet of head in your application to find a pump that provides the amount of water needed.

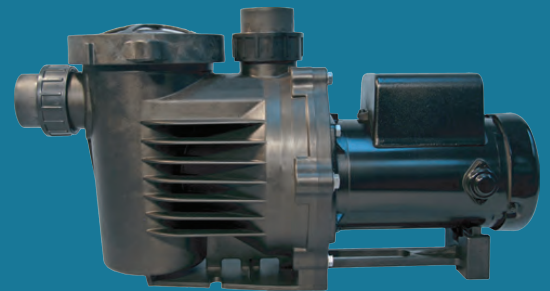
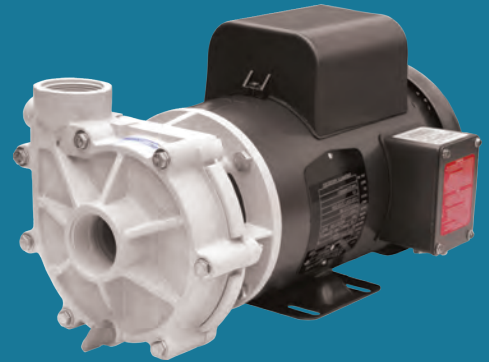

### PRO-TIP Operating an External Pump

Proper plumbing selection and set up is important when choosing to use an external pump. Below are some ways to set up an external pump with a skimmer. There are limits to how high a pump can be placed in a suction lift set up. Each pump is different, but these general layouts show how an external pump can be used. There are two basic set ups with an external pump: flooded suction or suction lift.

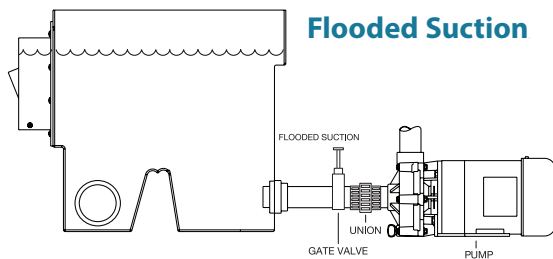

A flooded suction set up is where the pump is situated below the water level and the water flows by gravity to the pump.

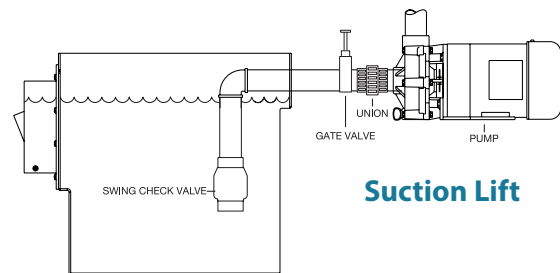

A suction lift set up is where the pump is located above the water level. "Suction lift" is a technical term for this set up, it does not mean that the pump acts like a vacuum cleaner.

#### Improper Plumbing Setup

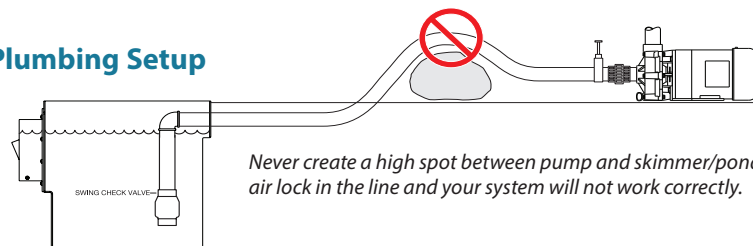

Never create a high spot between pump and skimmer/pond, it will create an air lock in the line and your system will not work correctly.

See [easypro.com](http://easypro.com) for more information on selecting the right pump





SINCE 1970

# EasyPro Pumps *Only Nature Does It Better*



## Medium Head External Pumps

If you are looking for great quality and an affordable price point, look no further!

- UL listed, 115v energy efficient motors with 6' power cords on all models
- Strainer basket with clear lid for easy inspection
- Safety rated for pool use
- GV100 and GV150 have horizontal/vertical discharge in one assembly
- 1½" fpt inlet/outlet with free unions on GV75S and GV100S
- 1½" slip PVC inlet/outlet with free unions on GV100 and GV150

**2 Year Warranty**



All pumps performance tested before leaving factory

Part #	hp	115v Amps	Self Priming	gpm @ feet of head					Maximum Head	Stocking Code	Ship Weight	List Price
				10'	20'	30'	40'	50'				
GV75S	3/4	8.8	Yes	71	65	56	42	21	60'	6435997	21 lbs.	\$544.99
GV100S	1	12	Yes	89	85	77	66	52	68'	8484792	23 lbs.	\$605.99
GV100	1	12	No	117	106	86	50	-	47'	3468794	33 lbs.	\$585.99
GV150	1.5	16	No	140	129	116	96	37	58'	8623991	34 lbs.	\$779.99



## Variable Speed Pumps

Allows user to speed up or slow down motor for maximum energy savings

- Unique design allows motor to operate at various rpms
- Easy to use digital keypad allows for single programming
- Self-priming
- No power cord - set up to be hard wired
- Safety rated for pool use
- Totally enclosed, fan cooled motors, no weather protection needed
- VSP165N - 1.65 hp, 230 volt single phase power input
- VSP270N - 2.7 hp, 230 volt single phase power input
- **Free Unions Included!**

**2 Year Warranty**

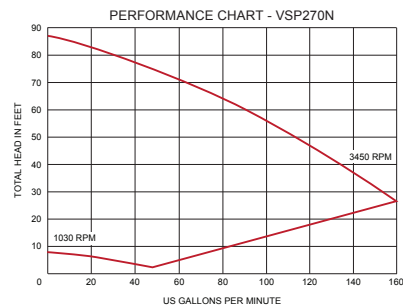
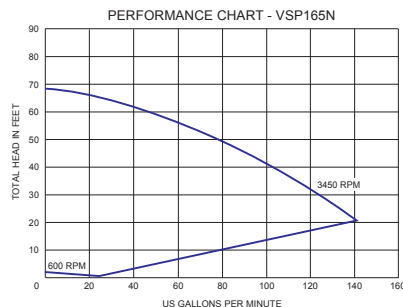

Part #	Max. hp	Max. 230v Amp	Inlet/Outlet	Max. Flow (gph)	Max. Head (ft)	Stocking Code	Ship Weight	List Price
VSP165N	1.65	6.8*	2"	8,400	68'	3122992	21 lbs.	\$1499.99
VSP270N	2.70	11.1*	2"	9,600	87'	21533394	23 lbs.	\$1869.99

\* Actual amp draw will depend on operating rpm speed





## External Pumps



EX6100



### External Low Head Pumps

Ideal for koi ponds, external filters and low head water falls, these reliable pumps are a great value!

- Continuous duty, weatherproof motors — can be used outdoors without additional protection from weather
- 8' power cord included
- Not self-priming — use in flooded suction applications or with check valve on suction line to maintain prime
- All sizes (except EX3600) have dual voltage motors, pumps are shipped 115v but can easily be field changed to 230v

**Extra Quiet Operation!**

Part #	Max. Flow gph	Watts	Max. Amps 115v	Inlet/Outlet	gpm @ feet of head				Max. Head	Warranty	Stocking Code	Ship Weight	List Price
					5'	10'	15'	20'					
EX3600	3600	139	1.4	2"/1½"	52	34	-	-	12'	18 months	7517498	21 lbs.	\$689.99
EX4500	4500	252	2.7	1½"	67	56	41	15	21'	18 months	8524995	25 lbs.	\$699.99
EX6100	6100	366	3.1	1½"	92	79	65	40	23'	18 months	5532497	25 lbs.	\$709.99
EX8800	8200	449	4.4	2"	120	103	84	48	22'	3 years	5802499	32 lbs.	\$1069.99

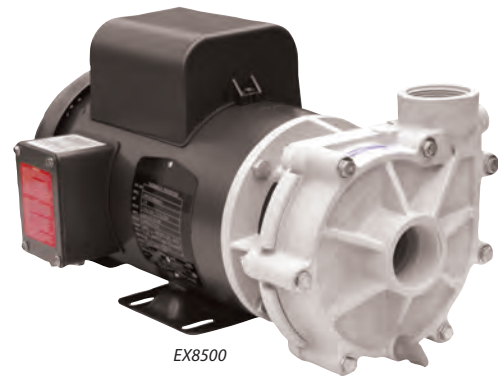

EX8500



### External High Head Pumps

The perfect choice for tall waterfalls, fountain nozzles and long or restrictive plumbing applications

- Continuous duty, weatherproof motors — can be used outdoors without additional protection from weather, 8' power cord included
- Not self-priming — use in flooded suction applications or with check valve on suction line to maintain prime
- EX8500 and EX11000 have dual voltage motors, pumps are shipped 230v but can easily be field changed to 115v
- EX11200 and EX13200 are 230v only

Part #	Max. Flow gph	Watts	Max. Amps 230v	Inlet/Outlet	gpm @ feet of head						Max. Head	Warranty	Stocking Code	Ship Weight	List Price
					20'	30'	40'	50'	60'	70'					
EX8500	8500	1385	5.4	1½"	116	100	80	51	-	-	55'	3 years	2899996	50 lbs.	\$1199.99
EX11000	11000	2056	8.6	1½"	-	143	125	106	80	33	72'	3 years	5104992	53 lbs.	\$1399.99
EX11200	11200	2162	9.6	2"	-	-	138	122	102	75	80'	3 years	3112494	63 lbs.	\$1499.99
EX13200	13200	2595	11.5	2"	-	-	175	150	141	117	80'	3 years	6116994	68 lbs.	\$1559.99



## Optional Strainer Baskets for EX Pumps



EXS901

- Use as a prefilter before the pump
- Can be used with other brand pumps
- 2" slip half union on both for inlet plumbing from pond
- Clear lids for easy inspection
- Removable strainer basket
- Includes unions on inlet/outlet for easy removal of pump



Part #	Size	Pump Connection	Stocking Code	Ship Weight	List Price
EXS901	90 cu. in.	1½" mpt	4138745	5 lbs.	\$184.99
EXS902	90 cu. in.	2" mpt	5138746	5 lbs.	\$184.99





SINCE 1970

## Self-Priming External Pumps



### EXP Series - The all-in-one!

An excellent blend of power, energy efficiency and durability. Designed with longevity in mind, these rugged units feature corrosion and abrasion resistant components, stainless steel shaft seal, integrated strainer basket and self-priming convenience.

- Designed for continuous operation
- Long life, corrosion resistant, stainless steel shaft seal
- Dual voltage motors - voltage can easily be field changed. 8' 115v cords included on all models except for EXP9500HP, which has no cord and must be hard-wired.
- Approximate dimensions: 12.75" tall x 10.75" wide x 25.75-28.375" long
- 2" union fittings are included
- Very quiet motors
- 3 year limited warranty

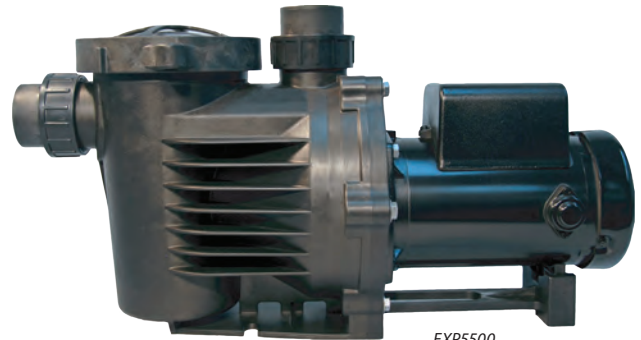

EXP5500

#### EXP Self-Priming, Low Head External Pumps

- Dual voltage motors with 8' power cord. Pumps are shipped 115v but can easily be field changed to 230v
- Very quiet operation. Motor is totally enclosed and fan cooled (TEFC) for durability.

Part #	Maximum Flow gph	Maximum Watts	Maximum Amps 115v	gpm @ feet of head				Maximum Head	Stocking Code	Ship Weight	List Price
				5'	10'	15'	20'				
EXP4000	4260	195	1.96	59	44	27	-	17'	61016798	53 lbs.	\$1311.99
EXP5500	6060	350	3.06	88	75	28	34	23'	61100497	53 lbs.	\$1419.99
EXP6500	6800	450	4.00	106	91	75	56	25'	41146993	58 lbs.	\$1479.99
EXP7500	7960	600	5.42	-	118	98	75	26'	71182642	58 lbs.	\$1525.99



#### EXP Self-Priming, High Head External Pumps

- Powerful, continuous duty motors
- Very quiet motors — Open drip proof (ODP) design does require protection from weather
- Ideal for formal fountains and other applications needing high pressure
- EXP6500HP: Dual voltage motor with 8' power cord. Pumps are shipped 115v but can easily be field changed to 230v.
- EXP9500HP: Dual voltage motor. Pumps are shipped with no cord - pump must be hard-wired.

Part #	Maximum Flow gph	Maximum Watts	Maximum Amps	gpm @ feet of head						Maximum Head	Stocking Code	Ship Weight	List Price	
				10'	20'	30'	40'	50'	60'					70'
EXP6500HP	6660	980	8.44/115v	104	90	76	57	25	-	-	54'	61038493	63 lbs.	\$1339.99
EXP9500HP	9650	1900	8.31/230v	152	146	133	119	104	88	67	83'	71214424	63 lbs.	\$1566.99



### Self Priming, External Pumps

These pumps offer higher flow rates and higher head pressures

They are ideal for medium flow, medium head applications where the safety of an external pump and the convenience of a self primer are desired.

- Self priming — will prime up to 5' above water level
- 3" inlet/outlet unions included
- Extra large strainer basket — reduces cleaning frequency
- Very quiet motors — open drip proof design does require protection from weather
- PCA75 is dual voltage and can be field changed to 230v — 1.5, 3 and 5 hp are 208-230 volt only

**3 Year Warranty!**



PCA150

Part #	hp	Maximum Flow gph	Maximum Amps/Volts	Inlet/Outlet	gpm @ feet of head						Maximum Head	Stocking Code	Ship Weight	List Price
					0'	10'	20'	30'	40'	50'				
PCA75	3/4	10680	11/115v	3"	183	161	129	90	-	-	39'	81348494	61 lbs.	\$1739.99
PCA150	1.5	13560	9.2/230v	3"	-	226	195	163	113	-	48'	31542242	66 lbs.	\$1989.99
PCA300	3	17800	13.4/230v	3"	-	305	276	236	196	145	58'	61859995	67 lbs.	\$2399.99
PCA500	5	19740	17.6/230v	3"	-	-	312	282	246	202	65'	52084741	75 lbs.	\$2689.99



3/4 hp pump includes 6' 115 volt power cord. 1.5, 3 and 5 hp pumps do not include cord





SPVS270



## High Flow, Variable Speed Pumps

**18 Month Warranty**

Features an 1081 pool-rated motor. Variable speed allows user to speed up or slow down motor for maximum energy savings

- Unique design allows motor to operate at various rpms
- Easy to use digital keypad allows for custom programming
- No power cord - set up to be hard wired
- Totally enclosed, fan cooled motors, no weather protection needed. Unions included.

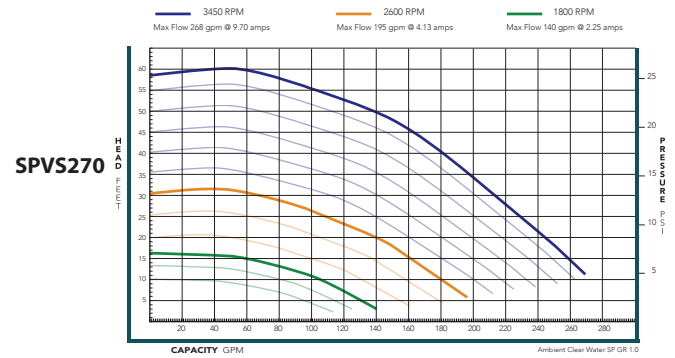
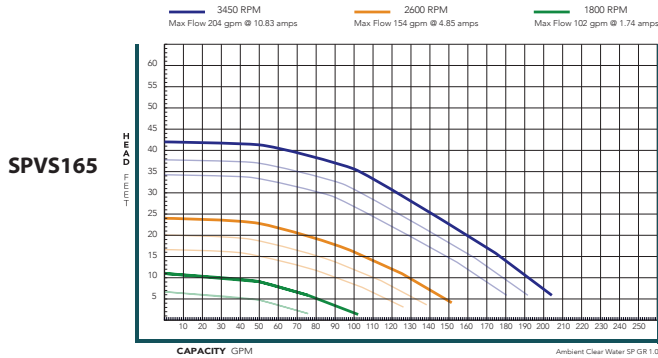

Part #	Max. hp	Max. Amps	Inlet/Outlet	Max. Flow (gpm)	Max. Head (ft)	Stocking Code	Ship Weight	List Price
SPVS165	1.65	10.83* @ 115	3"	204	42'	32014993	55 lbs.	\$2599.99
SPVS270	2.7	9.7* @ 230	3"	268	57'	72479991	57 lbs.	\$3199.99

\* Actual amp draw will depend on operating rpm speed



## SPECK pumps Swim-Rated Pumps from Speck Pumps

DPPP pool-rated. High efficiency, high pressure and high flow models.



SPHE05

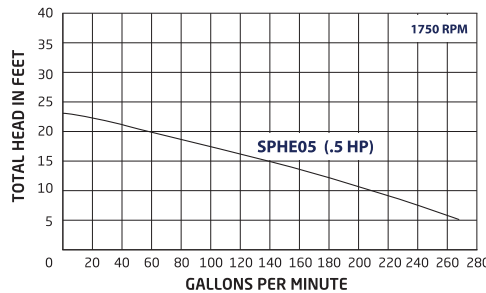

### High Efficiency

- Flooded suction pump - max flow at low head
- Extremely quiet – low 1750 RPM dual voltage motor
- Dielectric shaft sleeve provides absolute separation between pool water & electric parts
- "1081" E-plus®/extreme-E™ energy-efficient motor for extra low energy consumption.
- Equipped with 4" female slip adapter on strainer tank and 4" male slip adapters on the discharge.
- **Two year warranty**



SPHP40 / SPHF50

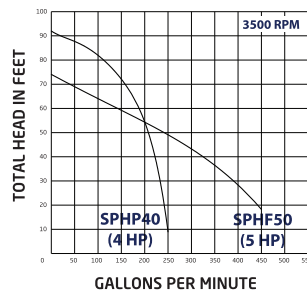

### High Pressure and High Flow

- Large one-piece housing design with integrated strainer basket for faster pump priming
- Can be used for pool water with a salt concentration of up to 5000 ppm
- Equipped with 4" quick disconnect unions for easy installation and maintenance. Wrench for unions and lid is included.
- NSF-50 standard
- **Two year warranty**



Part #	Description	hp	Max. Amps	Inlet/Outlet	Max. Flow (gpm)	Max. Head (ft)	Stocking Code	Ship Weight	List Price
SPHE05**	Speck High Efficiency Pump	.5	9.0* @ 115 / 4.5* @ 230	4"	265	23'	73616206	74 lbs.	\$4410.00
SPHP40**	Speck High Pressure Pump	4	19.4* @ 230	4"	250	95'	62544468	81 lbs.	\$3103.00
SPHF50**	Speck High Flow Pump	5	23.0* @ 230	4"	450	74'	83844982	133 lbs.	\$4689.00

\* Actual amp draw will depend on operating rpm speed \*\*All Speck Pumps will be drop-shipped from Speck



SINCE 1970

# Pumps & Accessories



## Submersible Pump Screens

Use these handy intake screens with any submersible pump when pumping water from a lake, pond, river or tank. These sturdy built screens will protect pump from sticks, weeds, fish and other large debris.

- Available in two sizes — 12" diameter x 14" tall or 20" diameter x 18" tall
- Heavy duty 1/2" x 1" epoxy coated, galvanized, mesh screen
- Drawstring top allows for easy pump removal/inspection and will draw up tight to any pipe from 1 1/2" to 4" in diameter
- Screens can be used vertically or horizontally



SPS20 shown with EasyPro TH150 Pump



Part #	Description	Stocking Code	Ship Weight	List Price
SPS12	Pump screen, 12" diameter x 14" tall	6112497	7 lbs.*	\$149.99
SPS20	Pump screen, 20" diameter x 18" tall	8172492	18 lbs.*	\$229.99

\*Dimensional shipping rate applies



## High Volume Centrifugal Pump Intake Filters

For high volume pumping applications these heavy duty pump intake screens are the answer

For most high volume pumps, these filters are a better choice as they will allow fine particles through — so screens will not plug up as often yet will still keep out large objects such as sticks, fish and weeds.

- Epoxy coated heavy gauge galvanized wire, will not rust or corrode
- Mesh size is 1/2" x 1"
- Includes PVC swing check valve to keep pumps primed



Four PIF8 Intake Filters used to create a 5000 gpm waterfall



Part #	Pipe Size	Screen Size		Flow (gpm)	Stocking Code	Ship Weight	List Price
		Length	Diameter				
PIF2	2"	18"	11"	90	6149997	10 lbs.*	\$199.99
PIF3	3"	30"	11"	225	5232493	15 lbs.*	\$309.99
PIF4	4"	30"	11"	350	6284992	20 lbs.*	\$379.99
PIF6	6"	48"	20"	700	5637495	51* lbs.	\$849.99
PIF8	8"	48"	20"	1250	7974991	72* lbs.	\$1299.99

\*Dimensional shipping rate applies



PIF6 & PIF8



## Intake Filter Supports

- Supports attach to each end of EasyPro® intake filters to keep them up off the pond bottom
- Made of 14 gauge powder coated steel
- Set includes two supports and self-tapping screws
- Intake filter sold separately above.

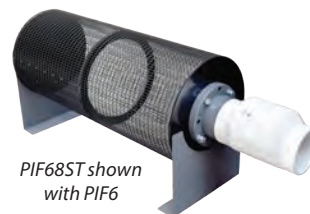

PIF68ST shown with PIF6



PIF234ST

Part #	Size	Fits	Stocking Code	Ship Weight	List Price
PIF234ST	10.5" x 13.25"	PIF2, PIF3, PIF4	2112491	4 lbs.	\$149.99
PIF68ST	19" x 16.25"	PIF6, PIF8	8149993	6 lbs.	\$199.99





# Flexible PVC Pipe



SINCE 1970

All EasyPro® flexible PVC pipe is made in the USA from virgin materials ensuring the highest quality

- Available in ½" through 4" diameters
- All sizes will glue into schedule 40 PVC fittings — no special fittings or glue required
- Very flexible — temperature range is -10°F to 130°F
- Eliminates back pressure caused by sharp turns in standard PVC fittings and increases flow
- Increases efficiency of system while reducing fittings and installation time
- Rolls up to 2" can ship Small Parcel, 3" and larger rolls must ship via motor freight
- Dimensional shipping rates may apply



## Premium Pond Flex



	Part #	Size	Stocking Code	Ship Weight	List Price
½"	BT5	25' roll	637498	4 lbs.	\$49.99
	BT50	50' roll	874999	11 lbs.	\$99.99
¾"	BT7	25' roll	738994	6 lbs.	\$51.99
	BT75	50' roll	477991	12 lbs.	\$103.99
1"	BT10	25' roll	344996	8 lbs.	\$59.99
	BT100	50' roll	789996	16 lbs.	\$119.99
1¼"	BT12	25' roll	756243	11 lbs.	\$74.99
	BT125	50' roll	3112492	21 lbs.	\$149.99
1½"	BT15	25' roll	356243	13 lbs.	\$74.99
	BT150	50' roll	4112494	26 lbs.	\$149.99
	BT1501	100' roll	8217497	50 lbs.	\$289.99
2"	BT20	25' roll	867491	19 lbs.	\$89.99
	BT200	50' roll	7134996	37 lbs.	\$179.99
	BT2001	100' roll	3269992	75 lbs.	\$359.99
3"	BT30 <sup>†</sup>	25' roll	4138741	32 lbs.	\$184.99
	BT300 <sup>†</sup>	50' roll	9262496	61 lbs.	\$349.99
	BT3001 <sup>†</sup>	100' roll	8524997	122 lbs.	\$699.99



<sup>†</sup>3" rolls ship via motor freight only

## Ultimate Pond Flex



For over two decades we have sold this industrial grade pipe with great results. It will withstand the extreme cold of Canadian winters, scorching hot Texas summers and everything in between!

Don't take chances on cheap imported pipe.

The original and absolute best quality pipe available!

	Part #	Size	Stocking Code	Ship Weight	List Price
1½"	FP15	25' roll	467493	13 lbs.	\$89.99
	FP150	50' roll	3138748	26 lbs.	\$184.99
2"	FP20	25' roll	4108745	19 lbs.	\$144.99
	FP200	50' roll	7217495	37 lbs.	\$289.99
	FP2001	100' roll	1427495	75 lbs.	\$569.99
3"	FP30 <sup>†</sup>	25' roll	2191246	32 lbs.	\$254.99
	FP300 <sup>†</sup>	50' roll	9382492	61 lbs.	\$509.99
	FP3001 <sup>†</sup>	100' roll	2764995	122 lbs.	\$1019.99
4"	FP40 <sup>†</sup>	25' roll	6487491	48 lbs.	\$649.99
	FP400 <sup>†</sup>	50' roll	8929994	95 lbs.	\$1239.99



<sup>†</sup>3" rolls and larger all ship via motor freight only

We offer one of the largest selections of sizes anywhere in the country!

## PRO-TIP Maximum Recommended Flow Rates for Flexible PVC Pipe

½" 8 gpm (480 gph)	1¼" 45 gpm (2,700 gph)	3" 225 gpm (13,500 gph)
¾" 15 gpm (900 gph)	1½" 60 gpm (3,600 gph)	4" 350 gpm (21,000 gph)
1" 25 gpm (1,500 gph)	2" 90 gpm (5,400 gph)	



\*Direct drive pumps assumed



SINCE 1970

# Kink Free & Vinyl Tubing

## Kink Free Tubing

High quality kink free tubing is a popular choice for pond and water garden applications

- Smooth inside for maximum flow, ribbed outside for increased strength
- Will not crimp or collapse around curves
- Installs with less fittings than rigid tubing due to flexibility
- Safe for fish and plants
- Temperature range of -15°F to 190°F



### Bulk Rolls for maximum savings

Part #	Description	Size	Similar US Size	Roll Length	Stocking Code	Ship Weight	List Price
<b>MNK07B</b>	Kink Free Tubing	19 mm	3/4"	100'	493742	15 lbs	\$124.99
<b>MNK10B</b>	Kink Free Tubing	25 mm	1"	100'	7112492	17 lbs.	\$149.99
<b>MNK12B</b>	Kink Free Tubing	32 mm	1 1/4"	100'	8127493	24 lbs.	\$169.99
<b>MNK15B</b>	Kink Free Tubing	38 mm	1 1/2"	100'	5149997	30 lbs.*	\$199.99
<b>MNK20B</b>	Kink Free Tubing	51 mm	2"	50'	8112496	38 lbs.*	\$149.99



## Prepackaged 12' Rolls Kink Free Metric Tubing

### Ideal for retail sales

- Same high quality kink free tubing sold above in rolls
- Smooth inside for maximum flow, ribbed outside for increased strength
- Precut lengths are ideal for use with mag drive pumps and filters



Part #	Size	Similar US Size	Stocking Code	Ship Weight	List Price
<b>MNK0712</b>	19 mm	3/4"	715397	3 lbs.	\$21.99
<b>MNK1012</b>	25 mm	1"	618194	3 lbs.	\$25.99
<b>MNK1212</b>	32 mm	1 1/4"	820298	4 lbs.	\$28.99
<b>MNK1512</b>	38 mm	1 1/2"	726593	5 lbs.	\$37.99

## Black Vinyl Tubing

- Smooth inside and outside
- Flexible tubing has a temperature range of 5°F to 150°F
- 3/8" - 3/4" tubing has 1/8" wall
- 1" tubing has 3/16" wall

Part #	Size	Stocking Code	Ship Weight	List Price
<b>BVT375</b>	3/8" x 100'	537496	4 lbs.	\$49.99
<b>BVT500</b>	1/2" x 100'	552493	6 lbs.	\$69.99
<b>BVT750</b>	3/4" x 100'	389997	17 lbs.	\$119.99
<b>BVT1000</b>	1" x 100'	8142492	23 lbs.	\$189.99





## PVC Fitting & Plumbing Terms:

- SLP:** Slip (smooth)
- FPT:** Female threads
- MPT:** Male threads
- SPG:** Spigot fitting (fits inside of coupling)



All parts on this page\*



**Caps (SLP)**

Part #	Size	Stocking Code	Case Qty.	List Price
CAP05	1/2"	61037	250	\$1.59
CAP07	3/4"	81039	250	\$1.59
CAP10	1"	41363	250	\$2.09
CAP12	1 1/4"	21683	125	\$2.59
CAP15	1 1/2"	51948	50	\$2.99
CAP20	2"	72276	50	\$3.49
CAP30	3"	85528	15	\$8.49
CAP40	4"	910019	9	\$15.40



**Deep Socket Couplings (SLP x SLP)**

Part #	Size	Stocking Code	Case Qty.	List Price
CO05	1/2"	7843	250	\$1.29
CO07	3/4"	4979	250	\$1.49
CO10	1"	81292	100	\$1.99
CO12	1 1/4"	51425	50	\$2.19
CO15	1 1/2"	71427	50	\$2.19
CO20	2"	62073	25	\$3.19
CO30	3"	35848	10	\$8.99
CO40	4"	97794	6	\$11.99



**Male Adapters (MPT X SLP)**

Part #	Size	Stocking Code	Case Qty.	List Price
MA05	1/2"	61037	250	\$1.59
MA07	3/4"	81169	250	\$1.79
MA10	1"	41626	100	\$2.49
MA12	1 1/4"	61755	50	\$2.69
MA15	1 1/2"	32467	50	\$3.79
MA20	2"	82592	25	\$3.99
MA30	3"	97141	16	\$10.99
MA40	4"	79096	12	\$13.99



**90° Elbows (SLP X SLP)**

Part #	Size	Stocking Code	Case Qty.	List Price
EL05	1/2"	21031	250	\$1.59
EL07	3/4"	91108	150	\$1.69
EL10	1"	71626	50	\$2.49
EL12	1 1/4"	82275	50	\$3.49
EL15	1 1/2"	42596	50	\$3.99
EL20	2"	83447	20	\$5.29
EL30	3"	39429	8	\$14.49
EL40	4"	716241	3	\$24.99



**Reducer Bushings (SPG X SLP)**

Part #	Size	Stocking Code	Case Qty.	List Price
RB3412	3/4" x 1/2"	2971	250	\$1.49
RB1034	1" x 3/4"	41554	250	\$2.39
RB1210	1 1/4" x 1"	61948	150	\$2.99
RB1510	1 1/2" x 1"	82079	100	\$3.19
RB1512	1 1/2" x 1 1/4"	92072	100	\$3.19
RB2010	2" x 1"	32724	50	\$4.19
RB2012	2" x 1 1/4"	82726	50	\$4.19
RB2015	2" x 1 1/2"	62724	50	\$4.19
RB3015	3" x 1 1/2"	84543	25	\$6.99
RB3020	3" x 2"	94542	25	\$6.99
RB4020	4" x 2"	29091	10	\$13.99
RB4030	4" x 3"	79093	10	\$13.99



**Female Adapters (FPT X SLP)**

Part #	Size	Stocking Code	Case Qty.	List Price
FA05	1/2"	71168	250	\$1.79
FA07	3/4"	91423	250	\$2.19
FA10	1"	81422	100	\$2.19
FA12	1 1/4"	51815	50	\$2.79
FA15	1 1/2"	81947	50	\$2.99
FA20	2"	92593	25	\$3.99
FA30	3"	26498	10	\$9.99
FA40	4"	59747	5	\$14.99



**45° Elbows (SLP X SLP)**

Part #	Size	Stocking Code	Case Qty.	List Price
ELLO5	1/2"	61297	250	\$1.99
ELLO7	3/4"	91814	100	\$2.79
ELL10	1"	41948	100	\$2.99
ELL12	1 1/4"	52465	50	\$3.79
ELL15	1 1/2"	63242	50	\$4.99
ELL20	2"	33377	20	\$5.19
ELL30	3"	811692	8	\$17.99
ELL40	4"	321449	3	\$32.99



**Reducer Bushings (SPG X FPT)**

Part #	Size	Stocking Code	Case Qty.	List Price
RBT3412	3/4" x 1/2"	71426	500	\$2.19
RBT1034	1" x 3/4"	31945	250	\$2.99
RBT1210	1 1/4" x 1"	82728	150	\$4.19
RBT1510	1 1/2" x 1"	73056	100	\$4.69
RBT1512	1 1/2" x 1 1/4"	43053	100	\$4.69
RBT2010	2" x 1"	84022	50	\$6.19
RBT2015	2" x 1 1/2"	94029	50	\$6.19
RBT3020	3" x 2"	24678	25	\$7.19
RBT4030	4" x 3"	29746	25	\$14.99



**Deep Socket Tees (SLP X SLP X SLP)**

Part #	Size	Stocking Code	Case Qty.	List Price
TE05	1/2"	71239	150	\$1.89
TE07	3/4"	61362	100	\$2.09
TE10	1"	42534	50	\$3.89
TE12	1 1/4"	62273	40	\$3.49
TE15	1 1/2"	82593	25	\$3.99
TE20	2"	53379	15	\$5.19
TE30	3"	912992	5	\$19.99
TE40	4"	122747	3	\$34.99



**90° Street Elbow (SLP X SPG)**

Part #	Size	Stocking Code	Case Qty.	List Price
STL05	1/2"	32078	250	\$3.19
STL07	3/4"	72596	150	\$3.99
STL10	1"	43375	50	\$5.19
STL12	1 1/4"	34021	50	\$6.19
STL15	1 1/2"	94158	50	\$6.39
STL20	2"	66498	20	\$9.99
STL30*	3"	418391	10	\$22.99

\*No case discount available

## PVC Primer/Glue

- Medium bodied, fast setting
- For use on pipe up to 8" diameter
- Formulated for wet conditions
- Primer is recommended to clean pipe to ensure good glue bond

Part #	Size	Case Quantity	Stocking Code	List Price
<b>Glue</b>				
G4	4 oz.	24	26648	\$9.49
G8	8 oz.	24	610703	\$15.29
<b>Primer</b>				
PR4	4 oz.	24	65529	\$7.89
PR8	8 oz.	24	87831	\$11.19



## Schedule 40 Black PVC Fittings

We offer the three most popular PVC fittings in black. Available in 1½" and 2" sizes. Compatible with flex PVC using normal PVC glue.

Part #	Size	Description	Case Quantity	Stocking Code	Ship Weight	List Price
MAB15	1½"	Male adapter	50	43997	1 lb.	\$4.99
MAB20	2"	Male adapter	25	85279	1 lb.	\$6.59
ELB15	1½"	90° elbow	50	14957	1 lb.	\$6.19
ELB20	2"	90° elbow	25	67913	1 lb.	\$9.89
COB15	1½"	Coupling	50	23194	1 lb.	\$3.99
COB20	2"	Coupling	25	84795	1 lb.	\$5.99



## Reducer Coupling

Reduces PVC pipe down in size in one smooth step. Less back pressure than using a coupling with reducer bushing.

Part #	Size	Stocking Code	List Price
REC32	3" x 2"	427998	\$34.99
REC43	4" x 3"	327995	\$34.99
REC64	6" x 4"	239994	\$49.99



## Eccentric Reducer Coupling

Use when reducing larger size plumbing down to pump inlet. Helps prevent turbulence going into the pump which can cause cavitation.

Part #	Size	Stocking Code	List Price
ERC43	4" x 3"	166397	\$82.99
ERC64	6" x 4"	871996	\$89.99
ERC86	8" x 6"	2119195	\$148.99



## Specialty Fittings

Part #	Size	Stocking Code	List Price
--------	------	---------------	------------

### SLP x SLP x fpt

RTE15	1½" x 1½" x ½"	73898	\$5.99
RTE20	2" x 2" x ½"	24934	\$7.59

### SLP x SLP x SLP

RT1510	1½" x 1½" x 1"	63247	\$4.99
RT2015	2" x 2" x 1½"	43243	\$4.99
RT3020	3" x 3" x 2"	813976	\$21.49
RT4030	4" x 4" x 3"	923071	\$35.49

### MPT x SLP

RMA1520	2" x 1½"	34281	\$6.59
---------	----------	-------	--------

### MPT X SLP

RM142	1¼" x 1½"	82729	\$4.19
RM122	1½" x 2"	93504	\$5.39
RM253	2½" x 3"	414398	\$17.99



Reducing Tee  
RTE15 & RTE20



Reducing Tee  
RT1510, RT2015, RT3020  
& RT4030

## PVC Unions

SLIP x SLIP union glues onto PVC pipe or flex pipe.

Part #	Size	Stocking Code	List Price
UN1	1½"	46291	\$8.99
UN2	2"	810497	\$14.99
UN3	3"	652497	\$69.99
UN4	4"	382492	\$109.99
UN6	6"	9231992	\$289.99



Reducing Male Adapter  
RM142, RM122, RM253



Reducing Adapter  
RMA1520





## Suction Strainers

Use these polypropylene strainers to keep fish, rocks, sticks, etc. out of intakes on external pumps.

Part #	Inlet Size	Stocking Code	Ship Weight	List Price
SSP15	1½" fpt	711198	1 lb.	\$13.99
SSP20	2" fpt	411993	1 lb.	\$14.99
SSP30	3" fpt	228794	2 lbs.	\$35.99

## Nylon Tubing Fittings

Use with vinyl & kink free tubing on page 117 or QuickSink aeration tubing on page 74



TE25



TA1414



TC1414

### Elbow (barb x barb)

Part #	Size	Stocking Code	List Price
TE38	¾"	41328	\$1.89
TE50	½"	91328	\$1.89
TE75	¾"	71676	\$2.39
TE100	1"	42794	\$3.99
TE125	1¼"	23491	\$4.99
TE150	1½"	83981	\$5.69

### Male Adapters (mpt x barb)

Part #	Size	Stocking Code	List Price
TA1238	½" x ¾"	71187	\$1.69
TA1212	½" x ½"	61183	\$1.69
TA3438	¾" x ¾"	81392	\$1.99
TA3412	¾" x ½"	41394	\$1.98
TA3434	¾" x ¾"	81517	\$2.16
TA1034	1" x ¾"	61819	\$2.59
TA100	1" x 1"	32098	\$2.99
TA125	1¼" x 1¼"	42726	\$3.89
TA150	1½" x 1½"	72982	\$4.25

### Connectors (barb x barb)

Part #	Size	Stocking Code	List Price
TC3838	¾" x ¾"	8971	\$1.39
TC1212	½" x ½"	71048	\$1.49
TC3814	¾" x ¼"	91162	\$1.66
TC1238	½" x ¾"	41183	\$1.69
TC3434	¾" x ¾"	81607	\$2.29
TC100	1" x 1"	61782	\$2.54
TC125	1¼" x 1¼"	32284	\$3.25
TC150	1½" x 1½"	95287	\$7.54



### Tee (barb x barb x barb)

Part #	Size	Stocking Code	List Price
TT38	¾"	21184	\$1.69
TT50	½"	61328	\$1.89
TT75	¾"	21676	\$2.39
TT100	1"	82447	\$3.49
TT125	1¼"	53143	\$4.49
TT150	1½"	43636	\$5.19



### Brass Male Adapters (mpt x barb)

Part #	Size	Stocking Code	List Price
BA37	¼" x ¾"	62249	\$2.99
BA50	¼" x ½"	72993	\$3.99



John Post Landscape Services, Inc. (MI)

## Cam Lock Fittings

### Male Coupling x Female Thread

- Thread fitting onto a male adapter on the opposite piece of hose from the female coupling below
- This will allow an easy connect and disconnect

Part #	Size	Stocking Code	Ship Weight	List Price
CFA15	1½"	27198	1 lb.	\$8.99
CFA20	2"	78639	1 lb.	\$10.79
CFA30	3"	612792	2 lbs.	\$15.99
CFA40	4"	527998	3 lbs.	\$34.99



CFA15

Fast, easy disconnect fittings for pumps, hoses, etc. Locking handles ensure watertight seal



### Female Coupling x Female Thread

- Glue a male adapter on the end of the hose then thread this adapter onto the male adapter, handles lock closed for positive seal.

Part #	Size	Stocking Code	Ship Weight	List Price
CFD15	1½"	417437	1 lb.	\$21.79
CFD20	2"	819839	2 lbs.	\$24.79
CFD30	3"	629592	2 lbs.	\$36.99
CFD40	4"	244794	3 lbs.	\$55.99



CFD20

### Female Coupling x Male Thread

Part #	Size	Stocking Code	Ship Weight	List Price
CFB15	1½"	215197	1 lb.	\$18.99
CFB20	2"	817434	2 lbs.	\$21.79
CFB30	3"	327995	2 lbs.	\$34.99
CFB40	4"	541598	3 lbs.	\$51.99



CFB20

### Male Coupling x Male Thread

- Threads into outlet of pump or into female adapter

Part #	Size	Stocking Code	Ship Weight	List Price
CFF15	1½"	75839	1 lb.	\$7.29
CFF20	2"	46392	1 lb.	\$7.99
CFF30	3"	613197	2 lbs.	\$16.49
CFF40	4"	819926	3 lbs.	\$24.90



### Replacement Gaskets - Female Couplings

Part #	Size	Stocking Code	Ship Weight	List Price
CFG15	1½"	72394	1 lb.	\$2.99
CFG20	2"	82396	1 lb.	\$2.99
CFG30	3"	43193	1 lb.	\$3.99
CFG40	4"	23991	1 lb.	\$4.99



## Rubber Couplings

- Heavy duty rubber couplings for joining PVC pipes and flexible PVC pipes together
- Stainless steel clamps on each end ensure a watertight seal
- Ideal for use in repairing broken pipelines underground and for use in lines that will need to be taken apart in the future

Part #	Size	Stocking Code	List Price
RC12	1¼"	46825	\$9.09
RC15	1½"	68027	\$10.69
RC20	2"	98624	\$11.49
RC30	3"	39142	\$12.19

Part #	Size	Stocking Code	List Price
RC40	4"	214476	\$19.29
RC215	2" x 1½"	89446	\$12.59
RC32	3" x 2"	79143	\$12.19
RC43	4" x 3"	211847	\$15.79



## Valve Boxes

Use these handy boxes to conceal the valve underground and yet have easy access

- The 10" round box is ideal for individual valves, while the 14" x 19" rectangle box is great for multiple valves
- Box is black in color, lids are green
- Lids can be easily covered with mulch to disguise them in landscape areas

Part #	Size	Stocking Code	Ship Weight	List Price
VB10	10" diameter x 10" deep	433326	2 lbs.	\$42.99
VB14	14" x 19" x 12" deep	343998	7 lbs.	\$54.99

VB10



VB14



## Single Union PVC Ball Valves

Provides an easy spot to disconnect a pump, filter or sterilizer

- Full port ball generates minimum back pressure on pump
- Use in water or air systems up to 150 psi
- Slip x slip connections



UBV10

Part #	Size	Stocking Code	Ship Weight	List Price
UBV10	1"	913997	1 lb.	\$19.99
UBV15	1½"	427998	1 lb.	\$39.99
UBV20	2"	238494	2 lbs.	\$54.99

## PVC Ball Valves

Full flow opening and quarter turn operation

- Rated to 150 PSI
- EPDM seals and seats
- Available in SLP x SLP only



BV50

Part #	Size	Case Quantity	Stocking Code	Ship Weight	List Price
BV50	½"	15	62443	1 lb.	\$3.49
BV75	¾"	15	43214	1 lb.	\$4.59
BV100	1"	15	86293	1 lb.	\$8.99
BV125	1¼"	10	79096	1 lb.	\$12.99
BV150	1½"	10	89092	1 lb.	\$12.99
BV200	2"	10	412598	2 lbs.	\$17.99
BV300	3"	6	641994	5 lbs.	\$59.99
BV400*	4"	4	3103595	10 lbs.	\$147.99



\*Not eligible for case quantity discounts

## PVC Gate Valves

- Easy open/close operation
- Easy on/off
- Body is PVC (except 3" – ABS plastic)



Part #	Size	Maximum PSI	Stocking Code	Ship Weight	List Price
GV15	1½"	50	411246	1 lb.	\$14.99
GV20	2"	40	614991	1 lb.	\$19.99
GV30	3"	20	827746	2 lbs.	\$36.99
GV40	4"	18	295993	5 lbs.	\$127.99
GV60	6"	18	4374995	16 lbs.	\$499.99

## Heavy Duty Threaded Bulkhead Fittings

- Inside threads are female pipe thread, use male adapter to connect PVC flex pipe
- Locking nut is a left hand thread (counter clockwise to tighten)
- Thick EPDM gasket between head and tank/liner ensures leak free installations
- See chart below for hole size needed in tank wall for installation

Ideal for penetrations in pond liners!

Part #	Size	Hole Size	Case Quantity	Stocking Code	Ship Weight	List Price
<b>BF50N</b>	½"	1⅝"	25	28741	1 lb.	\$12.49
<b>BF75N</b>	¾"	1⅞"	25	69093	1 lb.	\$12.99
<b>BF100N</b>	1"	2¼"	25	410497	1 lb.	\$14.99
<b>BF125N</b>	1¼"	2¼"	20	610493	1 lb.	\$14.99
<b>BF150N</b>	1½"	3"	20	712595	1 lb.	\$17.99
<b>BF200N</b>	2"	3"	20	314692	1 lb.	\$20.99
<b>BF300N</b>	3"	4⅝"	10	848998	2 lbs.	\$69.99
<b>BF400N</b>	4"	5¾"	10	2118991	5 lbs.	\$169.99



5% CASE DISCOUNT

## Inline Flow Meter

This inline flow meter allows for accurate and reliable flow rate measurement without sticking floats or paddle wheels.

- Great for filter systems and UVs, 95-98% accuracy
- Can be installed right next to tees or elbows in any position
- 2" model has integrated check valve
- 2" body is CPVC, 3" and 4" body are PVC
- Fits schedule 40 or 80 pipe



5 Year Warranty!



Part #	Description	gpm	Stocking Code	Ship Weight	List Price
<b>FMV20</b>	2" Flow meter/check valve	10-110	7191998	2 lbs.	\$255.99
<b>FMV30</b>	3" Flow meter	90-220	4457498	4 lbs.	\$609.99
<b>FMV40</b>	4" Flow meter	160-300	6509992	6 lbs.	\$679.99

## PVC Check Valves

### Union Style

- Same as SLIP x SLIP with the addition of a union on each end
- The union allows you to glue your line together and still get it apart
- Much more secure connection than rubber couplings in high pressure applications



UCV20

### SLIP x SLIP Style

- These PVC swing check valves are recommended whenever maximum flow is needed
- Swing checks have full flow design for maximum gpm and are completely non-metallic ensuring years of use in water
- Ideal for use in fresh or salt water, are rated to 100 PSI, mount vertical or horizontal, and can be used with schedule 40 or 80 PVC pipe
- SLIP x SLIP only



SCV20

### PVC Swing Check Valves with Unions:

Part #	Size	Stocking Code	Ship Weight	List Price
<b>UCV15</b>	1½"	635191	2 lbs.	\$43.99
<b>UCV20</b>	2"	852797	3 lbs.	\$65.99
<b>UCV30</b>	3"	4108791	4 lbs.	\$135.99

### PVC Swing Check Valves without Unions:

Part #	Size	Stocking Code	Ship Weight	List Price
<b>SCV10</b>	1"	826795	1 lb.	\$33.49
<b>SCV12</b>	1¼"	528792	1 lb.	\$35.99
<b>SCV15</b>	1½"	730398	2 lbs.	\$37.99
<b>SCV20</b>	2"	847193	2 lbs.	\$58.99

Part #	Size	Stocking Code	Ship Weight	List Price
<b>SCV30</b>	3"	483194	3 lbs.	\$103.99
<b>SCV40</b>	4"	6118392	5 lbs.	\$147.99
<b>SCV60</b>	6"	8228793	13 lbs.	\$285.99
<b>SCV80</b>	8"	2444793	27 lbs.	\$555.99





## Complete Fish Systems are ideal for classrooms, aquaponics, hydroponics, retail fish sales and more!

Excellent filtration is the key to any fish system, which is why we use EasyPro® Pressurized Bead Filters for the best in mechanical and biological filtration.



RCS2BL

### The Fish System 1

This single tank set up requires less than 6' x 8' of space. Commonly used in retail stores and pond shops, but can also be found in many aquaculture classrooms.

#### System Includes:

- One PT6530 300 gallon fish tank - 65" diameter x 30" deep with pre-drilled drain holes for easy installation
- One EX3600 EasyPro® 3600 gph external pump. This whisper quiet, low-RPM pump is also energy efficient at only 1.4 amps
- One PBF1800 EasyPro® Bead Filter rated for up to 60 pounds of fish. Add the optional backflush blower to make your routine cleaning faster and use less water.
- Includes all necessary fittings, valves, unions, pipe, etc.

#### System 1

Part #	Stocking Code	List Price
RCS2N	41863806	\$2440.69



#### System 1 with Backflush Blower

Part #	Stocking Code	List Price
RCS2BL	32198198	\$2858.69

**Best Seller!**



RCS3N

### The Fish System 2

Dual 300 gallon tanks allow you to keep different species or sizes of fish in the same system. A best selling system due to its increased capacity with minimal additional cost to a single tank setup.

#### System Includes:

- Two PT6530 300 gallon fish tanks - each is 65" diameter x 30" deep with pre-drilled drain holes for easy installation
- One EX4500 EasyPro® 4500 gph external pump. This whisper quiet, low-RPM pump is also energy efficient at only 2.7 amps
- One PBF3600 EasyPro® Bead Filter rated for up to 150 lbs. of fish. Add the optional backflush blower to make your routine cleaning faster and use less water.
- Includes all necessary fittings, valves, unions, pipe, etc.

#### System 2

Part #	Stocking Code	List Price
RCS3N	72820941	\$3681.49



#### System 2 with Backflush Blower

Part #	Stocking Code	List Price
RCS3BL	13155335	\$4099.49



### Round, Flat Bottom Tanks

We've sold these tanks all over the United States and in Canada for a wide variety of applications including aquaculture production, koi display tanks, filtration tanks, holding tanks, etc. Tanks are nestable for reduced shipping cost. Does not contain bottom drain - use bulkhead fittings on page 119.

Part #	Diameter	Depth	Capacity	Stocking Code	List Price
PT6530	65"	30"	300 gallon	5631992	\$789.99



## Platinum Koi & Goldfish Food

EasyPro® has combined the latest in ingredients and technology to give you a superior fish diet. Developed through decades of research, these diets are fed by leading breeders and producers with consistently great results!



### Max Color Food

- A high quality feed designed to provide a staple diet and enhance vibrant colors in fish
- Fortified with spirulina and other marine ingredients to enhance the natural coloration of koi and goldfish
- 5.0 mm (3/16") floating pellet
- Ideal for larger fish
- Use when water temp is over 50°F (10°C)



30% Protein  
5% Fat  
3.5% Fiber  
12% Moisture

5% CASE DISCOUNT  
MAP PROTECTED

Part #	Description	Case Qty.	Stocking Code	Ship Weight	List Price
PC1	20 oz.	12	917996	2 lbs.	\$23.99
PC5	5 lbs.	4	733748	6 lbs.	\$44.99
PC33	33 lbs.	4	2140995	35 lbs.	\$187.99

MADE IN USA  
RETAIL READY

### Max Growth & Color Food

- A high performance diet designed for growing fish
- Fortified with spirulina and other marine ingredients for maximum color
- Does not cloud water
- 3.0 mm (1/8") floating pellet
- Ideal for young fish
- Use when water temp is over 50°F (10°C)



42% Protein  
6% Fat  
3% Fiber  
11% Moisture

5% CASE DISCOUNT  
MAP PROTECTED

Part #	Description	Case Qty.	Stocking Code	Ship Weight	List Price
PG1	20 oz.	12	718744	2 lbs.	\$24.99
PG5	5 lbs.	4	634495	6 lbs.	\$45.99
PG33	33 lbs.	4	3146241	35 lbs.	\$194.99

MADE IN USA  
RETAIL READY

### Cold Water Food (Wheat Germ)

- Wheat based diet ideal for feeding during colder periods of the year
- Low protein, low fat diet that is easily digested by fish during colder water temperatures
- 5.0 mm (3/16") floating pellet with two year shelf life
- Use when water temp is between 39°F (4°C) and 50° (10°C).



28% Protein  
4% Fat  
5% Fiber  
11% Moisture

5% CASE DISCOUNT  
MAP PROTECTED

Part #	Description	Case Qty.	Stocking Code	Ship Weight	List Price
CWF1	20 oz.	12	714244	2 lbs.	\$18.99
CWF5	5 lbs.	4	326628	6 lbs.	\$35.49

MADE IN USA  
RETAIL READY

### Game Fish Food

- High quality general purpose fish food designed for feeding trout, bluegill, catfish and other game fish in farm ponds and lakes
- Ingredient selection based on true fin fish digestibility testing
- Meets FDA requirements regarding restrictions on mammalian protein sources
- Floating pellets available in 3.0 mm (1/8") for younger fish or 5.0 mm (3/16") for larger fish



40% Protein  
10% Fat  
4% Fiber  
11% Moisture

This product contains marine protein and oil products, processed grain and vegetable products, processed poultry by-products, vitamins (including stable vitamin C), minerals and amino acids.

Part #	Description	Stocking Code	Ship Weight	List Price
FD18	44 lb. bag 1/8"	841756	2 lbs.	\$54.99
FD316	44 lb. bag 3/16"	741750	6 lbs.	\$54.99

MADE IN USA  
RETAIL READY



## Cross Section of a Typical Formal Fountain

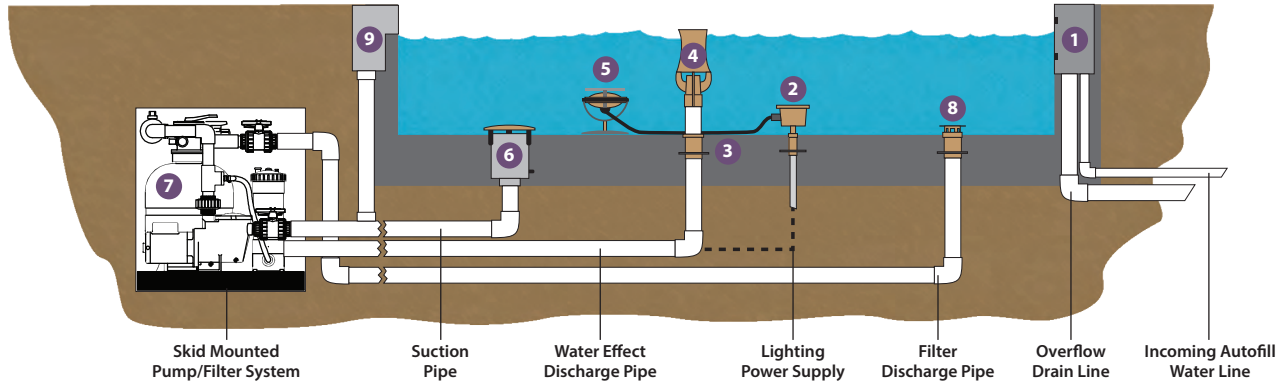

*Formal fountains can also be built with a sump in the floor holding a submersible pump instead of a skid mounted external system*



### Typical components used in a formal design. Depending on project, some or all may be used.



**1 Fill/Overflow Wall Box**  
Add water for evaporation loss or drain excess rainwater with these flush mount wall boxes.

See page 128



**2 Bronze Lighting Junction Box**  
Available for up to eight lines — combines all lighting cables into one supply box.

See page 133

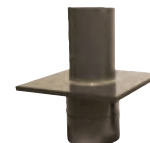

**3 Water Stop Flange**  
Prevents water loss along all PVC pipes penetrating through concrete walls/floor. Many sizes available.

See page 133



**4 Spray Nozzles**  
Many styles and sizes to choose from.

See pages 130-132



**5 Lighting**  
Create night time sizzle with underwater lighting.

See page 133



**6 Floor Drains**  
Intake water to pump comes from these floor drains.

Special Order



**7 Pump/Filter**  
A variety of pumps, filters and chlorinators are available as individual items or turn-key skid mounted systems as shown here.

See page 127



**8 Filter return**  
Excess water from pump/filter is returned up through floor inlets.

Special Order



**9 Wall Skimmer**  
Skims pool surface eliminating hand removal of debris.

See page 128



SINCE 1970

# Formal Fountains

## Skid Mounted Cartridge Filtration Systems Plug and Go!

These skid mount fountain filtration systems come fully plumbed and ready to work. Simply connect your incoming and outgoing water lines and installation is complete!

Small Base Kits come on a 16" x 22" base and include a pump and cartridge filter with all plumbing including a water bypass line around filter.

Medium Base Kits come on a 32" x 32" base and include a pump, cartridge filter and a chlorinator. Fully plumbed with Sch. 80 fittings and pipe including a bypass around the filter/chlorinator.



Small Base Kits

Medium Base Kits

**Each Skid Mounted Cartridge Filtration System is carefully quality tested in our facility before shipping.**

Part #	Pump Included	Amps @ 115v	gpm Flow	Filter Size	Chlorinator	Base Included	Stocking Code	Ship Weight	List Price
SMC90S	GV75S	8.8	70	90 sq. ft.	No	Small	31224497	50 lbs.	\$1579.99
SMC120S	GV100S	10	90	120 sq. ft.	No	Small	61317494	55 lbs.	\$1699.99
SMC90M	GV100	12	120	90 sq. ft.	Yes	Medium	21456991	77 lbs.	\$1879.99
SMC120M	GV150	16	140	120 sq. ft.	Yes	Medium	81619746	81 lbs.	\$2089.99



WeekEnding, Inc. (MI)

## Custom Skid Mount Cartridge Systems

EasyPro® builds these skid systems in house allowing us to build to your exact needs. Typically a filtration system is combined with a large, high volume pump for projects needing high flows. Contact us with your needs and we will provide you a quote based on your requirements.

## Cartridge Filters

Provides mechanical (not biological) filtration — ideal for formal fountains

- The injection molded tank construction provides dependable corrosion-free performance
- The filter is designed with a lock ring lid closer to make access for cleaning a snap
- Cartridge with 100% polyester media provides long cleaning cycles resulting in longer life
- Built-in air relief valve and pressure gauge
- Equipped with 1½" quick disconnect unions and large 1½" drain plug for easy debris removal



Part #	Description	Diameter x Height	Inlet/Outlet Size	Max gpm	Stocking Code	Ship Weight	List Price
PCF90	90 sq. ft. filter	10" x 28"	1½"	70	6359992	18 lbs.	\$449.99
PCF120	120 sq. ft. filter	10" x 34"	1½"	95	5447993	21 lbs.	\$559.99
PCF90C	Replacement cartridge element, 90 sq. ft.	-	-	-	9164798	5 lbs.	\$205.99
PCF120C	Replacement cartridge element, 120 sq. ft.	-	-	-	7212793	4 lbs.	\$265.99



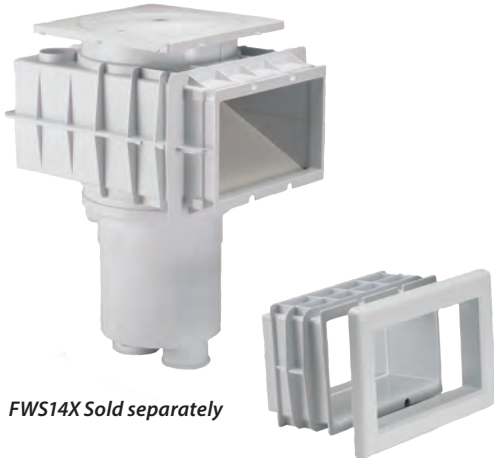

FWS14X Sold separately

## Concrete Wall Skimmers

Rugged design with large filter basket

- Pours into concrete wall along perimeter of pool — connects to external pump
- 2" fpt outlet to pump
- Cleanout lid can be secured with stainless screws and has adjustable height
- Throat extensions are available in 3/2" increments
- Can be used in tandem with floor drains



Part #	Description	Stocking Code	Ship Weight	List Price
<b>FWS14</b>	Wall skimmer, 14" wide	4224792	12 lbs.	\$280.99
<b>FWS14X</b>	Throat extension, 3/2"	926396	5 lbs.	\$32.99



## Chlorinator

Easy to install

- This simple in-line chlorine feeder is designed to install in the return water line (after the filter)
- 1 1/2" fpt inlet/outlet (unions not included)
- Built-in flow control to regulate chlorine levels in water
- Nine pound capacity

Part #	Stocking Code	Ship Weight	List Price
<b>CHL9</b>	4134991	5 lbs.	\$149.99

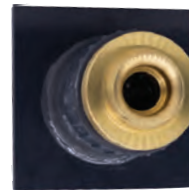

## "Eye Ball" Returns

Create adequate flow and circulation in formal pools with these high quality returns. Available in brass or high-strength PVC.



- Water stop flanges embed in concrete wall — eye ball threads into flange after pool is built
- 1 1/2" schedule 80 PVC connects to plumbing with PVC coupler. (sold separately)
- Eye balls are adjustable up to 15° in all directions.



Part #	Description	Stocking Code	Ship Weight	List Price
<b>EBR15B</b>	1 1/2" Brass Eye Ball Return	4299997	3 lbs.	\$399.99
<b>EBR15PL</b>	1 1/2" PVC Eye Ball Return	8149992	2 lbs.	\$199.99

## Wall Mount Autofill/Overflow Box

Protect your features from evaporation loss or overflow from excess rain water.

**Now includes mechanical autofill valve!**

- 8" x 10" box buries flush in concrete sidewall
- 3/8" fill is used to add makeup water to feature. Connect to water supply line.
- Includes 3/8" female npt pipe threads
- 2" overflow drains off excess rain water. Connect to drain.
- Stainless steel cover plate
- Pre-installed bonding lugs

Part #	Stocking Code	Ship Weight	List Price
<b>WMB810N</b>	2344996	9 lbs.	\$459.99



For more fountain options, check out our Lake & Pond Catalog!

Call 800-448-3873 or go to our website [easypro.com](http://easypro.com) to get your copy today!



## Arching Stream Fountain

Add a touch of elegance to any pond, pool or formal fountain with these arching jets of water

- Flow range of 800 gph to 1500 gph recommended, can be installed with most small pumps
- A 6' to 10' arch with heights of 5' to 6' is ideal, longer arches can be made when installing indoors where there is no wind
- For use in clean water applications, internal sponge filters remove fine particles that can disturb flow — periodic cleaning of sponges is necessary to maintain proper flow
- 1" barbed inlet
- Color changing LED light has 16' power cord/ transformer and remote control
- Discounts available when purchasing multiple units, please call for more information



**Snap Code for Video**

See the Arching Stream Fountain in action!



Riverside Casino (IA)

Kit includes pump, ball valve, fittings and 12' of tubing  
LED light remote control lets you choose and lock on any color or have it rotate through the colors



Part #	Description	Stocking Code	Ship Weight	List Price
ELN75	Arching laminar stream fountain w/multi color LED & remote control	9399998	12 lbs.	\$499.99
ELN75K	Arching laminar stream fountain kit (above) w/nozzle, 1000 gph pump & tubing	3547649	20 lbs.	\$699.09



## Trust EasyPro to help you create the perfect fountains!



Michael Akin (IN)



Beaubien Landscape, Inc. (MI)



Heritage Development (IL)

Since every feature is custom designed, we ask you to contact us with your plan details and we will prepare a quote for you. Due to the complex nature and extra time required, a nominal fee may be required on some jobs to prepare a quote.



## Smooth Jet Nozzles

Use these nozzles to build custom spray rings



Nozzles can be installed vertically or at an angle. This feature has smooth jet nozzles surrounding frothy nozzles.



**FCJN Series**

- Swivel base
- Built in flow adjustment screw allows you to easily change spray pattern
- Available in 1/2" and 3/4"
- Female threaded inlet



**AJN Series**

- Swivel base
- Larger diameter orifice for better sprays in windy conditions
- Available in 1/4" and 1/2"
- Male threaded inlet



**SJN Series**

- Swivel base
- Longest nozzle gives best arch — ideal for long distance sprays
- Available in 1/2" to 1 1/2"
- Female threaded inlet

**Performance Data:**

Part #	Inlet Size	Nozzle Orifice Size	2'		4'		6'		8'		10'		Stocking Code	Ship Weight	List Price
			gpm	head	gpm	head	gpm	head	gpm	head	gpm	head			
FCJN50	1/2"	1/4"	.7	4'	2	7'	2.5	10'	4	12'	-	-	317247	1 lb.	\$22.99
FCJN75	3/4"	5/16"	2.5	3'	3.5	5'	4	8'	6	10'	7	13'	232991	1 lb.	\$43.99
AJN25	1/4"	1/8"	.4	4'	.6	6'	.8	10'	1	12'	-	-	810495	1 lb.	\$13.99
AJN50	1/2"	1/4"	1.5	4'	2.5	6'	3.1	10'	3.6	12'	-	-	614995	1 lb.	\$19.99
SJN50	1/2"	3/16"	1	3'	2	5'	3	8'	5	11'	-	-	410498	1 lb.	\$13.99
SJN75	3/4"	1/4"	3	3'	4	5'	5	8'	7	11'	8	15'	717243	1 lb.	\$22.99
SJN100	1"	5/16"	5	3'	6	6'	8	8'	9	11'	11	14'	424741	2 lbs.	\$32.99
SJN150	1 1/2"	7/16"	8	3'	11	6'	15	8'	18	11'	21	15'	958492	2 lbs.	\$77.99



## Bronze Flush Mount Arching Jet Nozzle

Designed to be poured flush into concrete or Porous Pave

- Ideal for splash pads and formal pools
- Shoots a clear stream of water
- Adjustable eyeball can shoot straight up or be arched after installation
- Male threaded inlet



**Performance Data:**

Part #	Inlet Size	Nozzle Orifice Size	2'		3'		4'		6'		Stocking Code	Ship Weight	List Price
			gpm	head	gpm	head	gpm	head	gpm	head			
FMJ10	1"	3/8"	5	5'	6	6'	7	7'	8	8'	874991	2 lbs.	\$99.99



## Stainless Steel Foam Jet Nozzle

- Great for fountains with fluctuating water level
- Not water level dependent
- Overall size 2 1/2" diameter x 6 1/4" tall
- 1" male threaded inlet



**Spray Height:**

Part #	1'		2'		4'		6'		8'		Stocking Code	List Price
	gpm	head	gpm	head	gpm	head	gpm	head	gpm	head		
FJT10	13	2'	17	3'	22	5'	30	8'	34	22'	871246	\$94.99



## Bronze Frothy Nozzles

- Popular nozzle produces a thick, foaming geyser that creates an eye catching column of spray, often used in multiple nozzles, at different heights for a dramatic display
- Due to air being mixed with water at the nozzle, it is important that the water in the pool stays at a constant level
- Built-in swivel allows nozzles to tilt up to 15° any direction



Truestone Distributors (OH)

Spray Height:

Part #	Inlet Size	2'		4'		6'		8'		12'		Stocking Code	Ship Weight	List Price
		gpm	head	gpm	head	gpm	head	gpm	head	gpm	head			
FN1	1"	4	10'	8	14'	15	30'	20	44'	-	-	258491	2 lbs.	\$77.99
FN2	2"	28	7'	38	16'	42	23'	52	29'	64	38'	8127497	4 lbs.	\$169.99
FN3	3"	-	-	51	13'	76	20'	91	25'	110	39'	6299995	11 lbs.	\$399.99



## Bronze Aerating Nozzles

- Produces a narrow white water stream, swivel allows nozzle to tilt up to 15°
- Less water level dependent than Frothy (above) — unique design allows water level to fluctuate a few inches without affecting performance
- Female threaded inlet



Spray Height:

Part #	Inlet Size	2'		4'		6'		8'		12'		16'		Stocking Code	Ship Weight	List Price
		gpm	head	gpm	head	gpm	head	gpm	head	gpm	head	gpm	head			
AN1	1"	8	5'	13	9'	15	11'	17	16'	-	-	-	-	956243	1 lbs.	\$74.99
AN2	2"	16	8'	23	9'	30	13'	40	20'	47	30'	60	40'	6104998	3 lbs.	\$139.99



## Bronze Waterbell Nozzles

- Classic formal spray pattern
- Not water level dependent
- Female threaded inlet on WB10
- Male threaded inlet on WB20



Pondering Waters (MI)



Flow Diameter For:

Part #	Inlet Size	2' Diameter		3' Diameter		4' Diameter		Stocking Code	Ship Weight	List Price
		gpm	head	gpm	head	gpm	head			
WB10	1" fpt	6	5'	8	7'	15	11'	149497	2 lbs.	\$65.99
WB20	2" mpt	10	5'	13	7'	30	13'	693743	3 lbs.	\$124.99



## PVC Spray Nozzles

- Lower cost option to bronze nozzles with attractive white water columns
- Not water level dependent, has npt threaded inlets
- Available in two rocket and two umbrella spray patterns
- Same reliable nozzle used in the EasyPro® AquaFloat™ Floating Fountain



Rocket



Wide Umbrella



Narrow Umbrella

Spray Height:

Part #	Inlet Size	Spray Pattern	4'		6'		8'		12'		16'		Stocking Code	Ship Weight	List Price
			gpm	head	gpm	head	gpm	head	gpm	head	gpm	head			
SCFRN	2"	Rocket	35	8'	40	10'	45	13'	55	16'	65	23'	344998	3 lbs.	\$59.99
SCFRN3	3"	Rocket	63	8'	81	10'	91	13'	105	16'	128	25'	565992	5 lbs.	\$87.99
SCFWU	2"	Wide Umbrella	62	11'	77	14'	82	19'	-	-	-	-	944994	3 lbs.	\$59.99
SCFNU	2"	Narrow Umbrella	62	11'	77	14'	82	19'	-	-	-	-	744991	3 lbs.	\$59.99







## Fixed Jet Three Tier Nozzle

- Multi-tier display
- More defined streams than 3TN15
- Not water level dependent
- Female threaded inlet



Flow Data For:

Part #	Inlet Size	4' High		6' High		8' High		10' High		Stocking Code	Ship Weight	List Price
		gpm	head	gpm	head	gpm	head	gpm	head			
ASJ15	1½"	20	7'	24	9'	30	12'	25	15'	597491	2 lbs.	\$129.99



## Bronze Multi-Spray Nozzles

- Circular spray with hundreds of water droplets, an impressive display without a lot of sound
- Not water level dependent
- Use adequate screening on pump inlet to prevent debris from plugging nozzles
- Female threaded inlet



Flow Data For:

Part #	Inlet Size	2' High		4' High		6' High		Stocking Code	Ship Weight	List Price
		gpm	head	gpm	head	gpm	head			
MS10	1"	6	4'	11	7'	14	10'	852495	2 lbs.	\$69.99
MS20	2"	11	9'	16	15'	21	24'	467491	3 lbs.	\$89.99



## Bronze Fan Jet Nozzles

- Narrow or wide display
- Not water level dependent
- Screening required to prevent plugging
- Swivel base allows 15° tilting only on FJ1N
- Female threaded inlet



45° Spray Angle Data:

Part #	Inlet Size	2' Throw		3' Throw		4' Throw		6' Throw		Stocking Code	Ship Weight	List Price
		gpm	head	gpm	head	gpm	head	gpm	head			
FJ1N	1"	5	4'	6	5'	8	7'	10	9'	271241	2 lbs.	\$94.99
FJ1W	1"	14	4'	19	5'	21	8'	24	10'	689995	3 lbs.	\$119.99



## Bronze Three Tier Nozzles

- Nozzle is not water level dependent
- Use adequate screening on pump inlet to prevent debris from plugging nozzles
- Female threaded inlet



Performance Data For:

Part #	Inlet Size	2' High		4' High		6' High		8' High		Stocking Code	Ship Weight	List Price
		gpm	head	gpm	head	gpm	head	gpm	head			
3TN07	¾"	10	5'	15	8'	22	11'	-	-	241241	2 lbs.	\$54.99
3TN15	1½"	15	10'	20	14'	30	20'	40	25'	671245	3 lbs.	\$94.99





SINCE 1970

# Formal Fountains

## Brilliant LED Fountain Ring Lights

These IP68 rated stainless steel lights are designed to slide over top of fountain stand pipes and illuminate formal water features, they can also be used in waterfalls and ponds.

- 15' power cords
- 12v power, use with EasyPro® transformers on page 59
- Adjustable - lights can be mounted at desired height on stand pipe and secured in place with stainless mounting screws (included)
- 2800-3000 K warm white LED

Bright LED lights can be attached directly to fountain stand pipes!

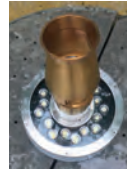

**5 Year Warranty!**

Part #	Description	Fits PVC Stand Pipe	Light Dimensions	Stocking Code	Ship Weight	List Price
<b>BFL9</b>	9 watt fountain light	1" diameter	6½" dia. x 2⅞" h	2164994	5 lbs.	\$219.99
<b>BFL12</b>	12 watt fountain light	1½" diameter	7⅞" dia. x 3⅞" h	6224994	6 lbs.	\$299.99
<b>BFL18</b>	18 watt fountain light	2" diameter	7⅞" dia. x 3⅞" h	4269992	7 lbs.	\$359.99



## Bronze Underwater Junction Boxes

- Connect multiple fountain lights to a single power supply with these bronze junction boxes
  - Available in two sizes - four or eight outlet
  - Also available with solid bottom or built-in 1" threaded inlet in bottom which can thread onto BWF10 bronze flange (below), once installed fill with junction box potting compound (sold separately)
  - UJC fills one UJ8 or two UJ4 boxes
- Not for use in swimming pools*



Beaubien Landscape, Inc. (MI)

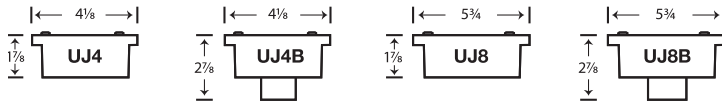
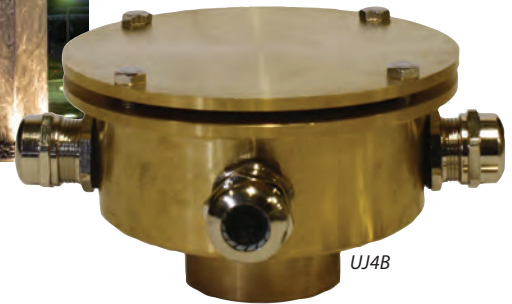

Part #	Description	Stocking Code	Ship Weight	List Price
<b>UJ4</b>	Four outlet junction box, no bottom inlet	5119992	3 lbs.	\$159.99
<b>UJ4B</b>	Four outlet junction box, 1" fpt bottom inlet	6134993	3 lbs.	\$179.99
<b>UJ8</b>	Eight outlet junction box, no bottom inlet	7202498	5 lbs.	\$269.99
<b>UJ8B</b>	Eight outlet junction box, 1" fpt bottom inlet	4217493	5 lbs.	\$289.99
<b>UJC</b>	Potting Compound	856948	1 lb.	\$66.99



## Waterstop Concrete Flanges

- See cross section on page 126 - item #3, for typical installation location
- Schedule 80 PVC for maximum durability
- Flange prevents water from seeping through concrete
- Available in 1" to 8" sizes
- 1" PVC flange has one male threaded end for mounting bronze electrical junction box (above)

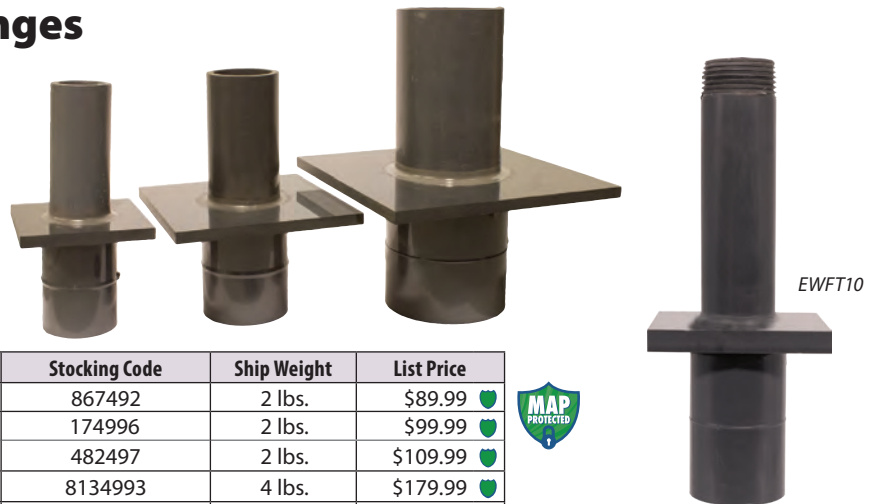

Part #	Size/Description	Overall Length	Stocking Code	Ship Weight	List Price
<b>EWFT10</b>	1" PVC flange - threaded	7½"	867492	2 lbs.	\$89.99
<b>EWF15</b>	1½" PVC flange	7½"	174996	2 lbs.	\$99.99
<b>EWF20</b>	2" PVC flange	8"	482497	2 lbs.	\$109.99
<b>EWF30</b>	3" PVC flange	10"	8134993	4 lbs.	\$179.99
<b>EWF40</b>	4" PVC flange	12"	2164994	5 lbs.	\$219.99
<b>EWF60</b>	6" PVC flange	14"	5247495	9 lbs.	\$329.99
<b>EWF80</b>	8" PVC flange	20"	6352496	14 lbs.	\$469.99





The “engine” that drives everything within a body of water is the presence of oxygen in proper levels. Installing diffused aeration in a pond or lake is the single most valuable water management and water maintenance strategy that can be implemented. The movement of oxygenated water from the bottom up provides many benefits to the water. As ponds age, organic muck load and total oxygen demands rise.

**Diffused aeration gets to the heart of the matter!** Oxygen is supplied by an on-shore compressor and delivered to diffusers placed on the bottom of the pond. The diffusers produce a cycling action of air bubbles that supplies the oxygen where it's needed most.

Stratified Without Aeration

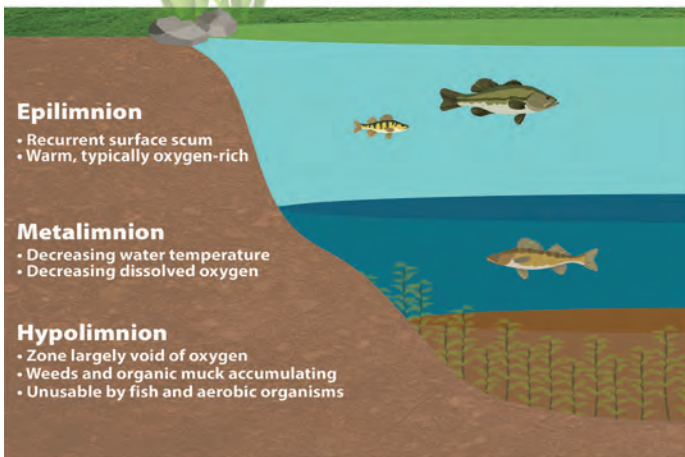

De-Stratified With Aeration

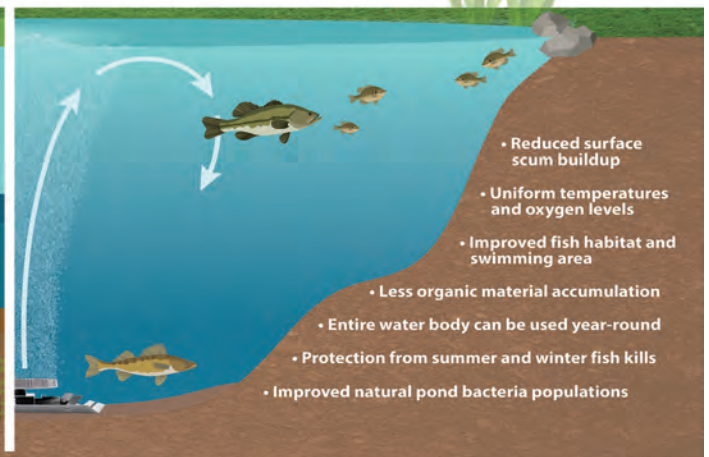

## 1 Aeration



Pages 138-141

## 2 Water Treatments



Pages 135-137

## 3 Weed & Algae Controls



Page 144

See our full line of aeration products water treatments, algaecides and herbicides in our Lake and Pond Management Catalog.



SINCE 1970

# Lake & Pond Dyes

## Concentrated Pond Dye — Liquid

These concentrated dyes will save you in shipping costs

- One quart is equal to one gallon of other dyes on the market
- This is a nontoxic and harmless pond dye for use in ponds and lakes
- Waters can be used for swimming and irrigation once product is dispersed
- Compatible with most aquatic herbicides and algaecides
- Black dye creates a more reflective surface appearance while the blue dye creates "Caribbean" blue water
- Serenity dye is a mix of blue and black

### Liquid Dosage Rate

One quart treats one acre of water 4' deep (approx. one million gallons)



Part #	Description	EPA Registered	Case Quantity	Stocking Code	Ship Weight	List Price
ECPD	Blue pond dye, 1 quart	No	12	820996	3 lbs.	\$29.99
ECPDBK	Black pond dye, 1 quart	No	12	822394	3 lbs.	\$31.99
ECPDSB	Serenity pond dye, 1 quart	No	12	321691	3 lbs.	\$30.99



Half and full pallet discounts available - contact us for high volume needs

## Concentrated Pond Dye — Powder

- Dry powder dye is cheaper to ship than liquid
- Four - 4 ounce water soluble packets (WSP) per pouch, simply toss into pond for easy application
- Safe for use with fish and aquatic life
- Three WSPs (water soluble packets) will treat one acre, 3'-4' deep
- Each WSP is double sealed in water soluble film

### WSP Dosage Rate

Each four ounce water soluble packet treats 1/3 acre, 3'-4' deep



### Great Value

- Buy a case of 5 pouches (20 WSPs)  
Treats 6.66 surface acres, 4' deep

### Best Value

- Buy a master case 20 pouches (80 WSPs)  
Treats 26.6 surface acres, 4' deep

Part #	Description	EPA Registered	Case Quantity	Stocking Code	Ship Weight	List Price
PD4P	Blue pond dye (dry), 4pk pouch	No	5	327298	2 lbs.	\$38.99
PD4PBK	Black pond dye (dry), 4pk pouch	No	5	730094	2 lbs.	\$42.99
PD4PSB	Serenity pond dye (dry), 4pk pouch	No	5	128698	2 lbs.	\$40.99





# Pond-Vive Beneficial Bacteria



SINCE 1970

**Our Best Seller!**



## Pond-Vive

The natural, biological way to revive your pond. A blend of enzymes and beneficial bacteria, with a concentration level of five billion colony-forming units per gram!

A proprietary blend of enzymes and beneficial bacteria formulated to help improve water quality and reduce sludge in ponds, lakes and other water bodies. Pond-Vive works best when used in conjunction with aeration.

- Reduce sludge buildup and eliminate pond odors
- Improve water clarity and reduce oxygen demand
- Eliminate excess nutrients
- Enzymes - four strains which break down waste into an easier digestible form for the bacteria — speeds up the process!
- Easy to use eight ounce water soluble packets or loose powder
- Reduces ammonia, nitrite, nitrate and phosphate
- Barley straw additive
- Cold weather bacteria strains, for results in temperatures as low as 38°F

### DOSAGE RATES<sup>†</sup>

For best results Pond-Vive should be added every two weeks when water temperatures are above 55°F (can be added at colder temperatures but results will be diminished). The amount needed depends on the condition of the pond.

**Newer ponds with little "muck"**

Apply 4 lbs. per surface acre/2 weeks

*For best results the initial application should be doubled to jump start the process.*

### Example — One 10 lb. Pail Treats:

Pond Size	Newer Pond	Older Pond
1/4 Acre	5 Months	3 Months
1/2 Acre	2.5 Months	1.5 Months
1 Acre	1.25 Months	.75 Months

**A 25 lb. pail extends months treated by 2.5 times**

Part #	Description	Case Quantity	Stocking Code	Ship Weight	List Price
--------	-------------	---------------	---------------	-------------	------------

#### Water Soluble Packets —

<b>PB5X</b>	10 Eight ounce water soluble packets (5 lbs.)	4	462991	6 lbs.	\$89.99
<b>PB10X</b>	20 Eight ounce water soluble packets (10 lbs.)	4	9104990	11 lbs.	\$149.99
<b>PB25X</b>	50 Eight ounce water soluble packets (25 lbs.)	2	6244991	29 lbs.	\$349.99
<b>PBX-50B</b>	100 Eight ounce water soluble packets (50 lbs.)	—	7440997	53 lbs	\$629.99

#### Loose Powder —

<b>PB25XL</b>	25 lb. Bucket (with 8 oz. scoop)	2	7225399	29 lbs.	\$321.99
<b>PB50XL</b>	50 lb. Bucket (with 8 oz. scoop)	2	7412993	53 lbs.	\$589.99
<b>PB100XL</b>	100 lb. Fiber drum (with 8 oz. scoop)	2	2818992	105 lbs.	\$1169.99



PB100XL



## Pond-Vive L — Liquid Lake & Pond Bacteria

- Similar to Pond-Vive powder
- Ideal for treating golf course ponds, farm ponds, municipal areas, etc.
- Works to remove ammonia, nitrates, phosphates and sludge
- Two gallons will treat 1/4 acre pond for 10-16 weeks
- Also available in 55 gallon drums and 250 gallon totes

### DOSAGE RATES<sup>†</sup>

**Initial Dose:** One gallon per surface acre every week for four weeks, then maintenance dose.

**Maintenance Dose:** One gallon per surface acre every two weeks

**Problem Ponds:** One gallon per surface acre every week until desired results, then maintenance dose.

Part #	Description	Case Quantity	Stocking Code	Ship Weight	List Price
<b>PB128</b>	Pond-Vive L, one gallon bottle	4	434998	10 lbs.	\$49.99

<sup>†</sup>Always refer to label for exact manufacturer's dosage rates and instructions.



**800-448-3873**



SINCE 1970

# Sludge Remover / Phosphate Binder

## Sludge Remover Pellets

Great for spot treating around docks, beaches or partially treating large ponds

Sludge Remover bacteria is designed specifically to remove organic sludge from the bottom of lakes and ponds. Sludge is the result of fish waste, dead algae or plant material, uneaten fish food, leaves and other debris. The pellets, when introduced to the water, sink, dissolve and begin to remove bottom organic sludge — often several inches per year.

Simply toss pellets or blocks in the water for easy application!

- Diminishes bottom sludge buildup
- Removes pond odors caused by stagnant water and decaying material
- Sinking pellets for precise and effective placement when spot treating
- Enhances water clarity and reduces murky water caused by organic wastes
- Helps lower oxygen demand in the pond
- Reduces problem causing nitrate and phosphates
- Fish, family and animal safe



Available in several sizes from 5 pound pails for retail to 50 pound boxes

### 3 Gram Pellets —

Part #	Description	Case Quantity	Stocking Code	Ship Weight	List Price
ABB05X	Sludge Remover pellets, 5 lb. pail	4	355997	6 lbs.	\$79.99
ABB10X	Sludge Remover pellets, 10 lb. pail	4	197992	11 lbs.	\$139.99
ABB25X	Sludge Remover pellets, 25 lb. pail	2	2230999	29 lbs.	\$329.99
ABB-50B	Sludge Remover pellets, 50 lb. box	—	8433997	53 lbs.	\$619.99

### DOSAGE RATES<sup>†</sup>

#### Spot Treatment

One ounce of pellets covers approx. 200 - 250 square feet of shoreline or beach area — apply every two weeks

#### Full Pond Treatment

Two 8 ounce scoops per 1/4 acre every two weeks



## EutroSORB® WC Liquid Phosphate Binder

Targets phosphorus in water bodies that have excess amounts

A proprietary solution developed specifically for rapid and stable inactivation of phosphorus from the water column of a variety of water bodies such as lakes, reservoirs, ponds, rivers, streams, canals, ditches, etc. EutroSORB® WC is a high performance, water-soluble phosphate binder that does not stain equipment or features.

- Easy to use formulation
- Does not require a slurry mix prior to application
- Does not impact water chemistry
- Safe for fish, invertebrates, and personnel
- No irrigation restrictions
- Minimal product use for noticeable results

### DOSAGE RATE<sup>†</sup>

1 quart per surface acre once monthly for 5 months through the warm season

Part #	Description	Case Quantity	Stocking Code	Ship Weight	List Price
ESWC	EutroSORB WC 2.5 gallon bottle	1	855993	17 lbs.	\$69.99

<sup>†</sup>Always refer to label for exact manufacturer's dosage rates and instructions.





The amount of surface area an aeration system will effectively cover is greatly dependent on two factors - depth and shape.

## Depth

The diagram to the right shows how much surface area is effectively aerated per air diffuser at various depths:

### Example

Our PA34 pond aerator would aerate only 1/8 of an acre if operated in 4' deep water, while aerating up to 1 1/2 acres if operating in 16' - 20' of water.

Ponds that are irregular or odd shaped will also reduce size of aeration area — call our technical assistance department for additional help.

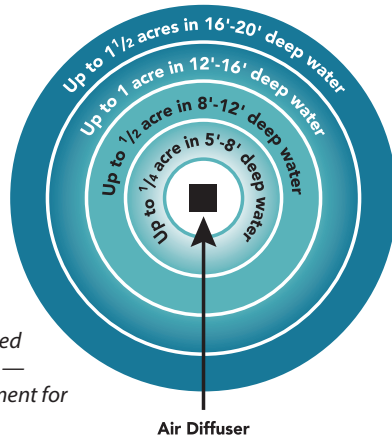

## Shape

Pond shape affects the amount of diffusers needed. Irregular shaped ponds require multiple diffusers to adequately aerate entire water column.

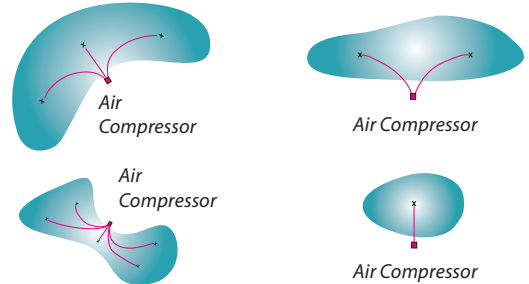

The deeper an air diffuser is located, the more "boiling action" it will create and a larger area will be aerated.

A unique shaped pond or lake will require more diffusers to cover the same surface area.

## Rocking Piston Systems

Base Part #	Horse Power	Diffusers Included	5' - 8' Deep	8' - 12' Deep	12' - 16' Deep
PA34	1/4 hp	1 or 2	up to 1/8 acre	up to 1/2 acre	up to 1 acre
PA65	1/2 hp	2	up to 1/4 acre	up to 1 acre	up to 2 acres
PA66	1/2 hp	3	up to 3/4 acre	up to 1 1/2 acres	up to 3 acres
PA86	3/4 hp	4	up to 1 acre	up to 2 acres	up to 4 acres

## Aeration Kits for Shallow Ponds

For ponds 7' deep or less these linear powered aeration systems are a great choice

- Extremely energy efficient
- Very quiet operation
- Long lasting, oil free design
- Weather resistant enclosures - can be used outdoors, for maximum longevity use additional protection from elements
- Now with self weighted diffusers for easier installation
- Three year warranty on compressors, five years on tubing/diffusers

Choose from either single or double diffuser system. Single diffuser is ideal for round or regular shaped ponds. Use the dual diffuser system for long and narrow or irregular shaped ponds. Both kits include QuickSink tubing for easy installation.



PA8SWN



PA6SWN

Part #	Description	1/2" QuickSink Tubing	Stocking Code	Ship Weight	List Price
PA6SWN	Single diffuser system with KLC60 compressor	50'	1412498	22, 27 lbs.	\$549.99
PA8SWN	Double diffuser system with KLC80 compressor	100'	7627744	28, 60 lbs.	\$836.99

### Shallow Water Diaphragm Repair Kits

KLC68DK	Diaphragm repair kit for KLC60/KLC80 compressors	—	549127	1 lb.	\$65.49
KLC468F	Filter replacement for KLC60/KLC80 compressors	—	64421	1 lb.	\$5.89





SINCE 1970

# Windmill Aeration



A Division of EasyPro Pond Products®

## Wind Driven Aerators



Let Mother Nature aerate your pond

Windmill aerators can save \$30-\$50 per month in electric costs, paying for themselves in a few short years. Ideal for aerating remote ponds with no electricity nearby.

- Stable, four leg design
- Long-lasting, reinforced neoprene diaphragm
- 6' diameter head with 12 blades operates in wind as low as five mph
- Produces 2.4-5 cfm (depending on air speed) for ponds up to 40' deep
- Over speed protection — tail section will turn head in high winds preventing over spinning
- Includes 48" long anchor stakes
- Includes hinge set
- Can effectively aerate ponds up to two acres depending on shape and depth
- Windmills can sit up to 1000' away from pond's edge — use poly tubing sold in our Lake & Pond Management catalog

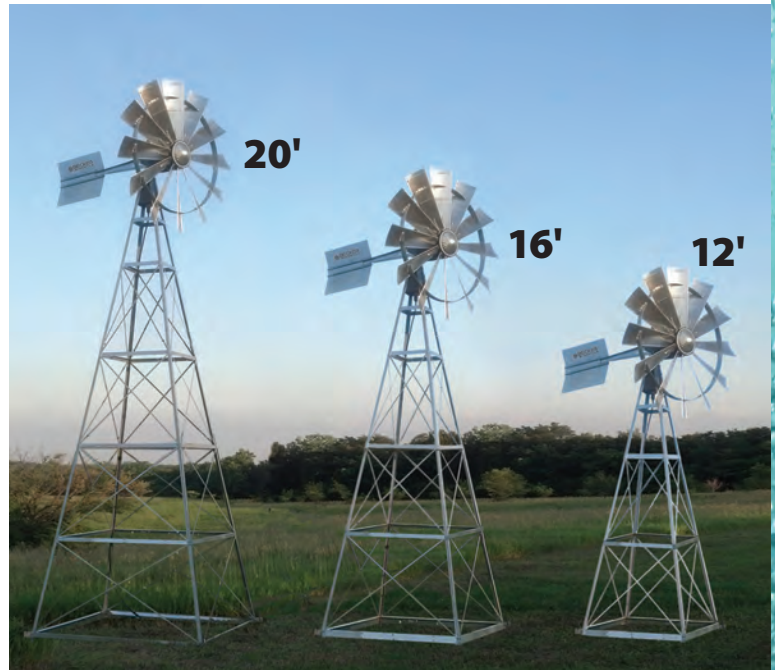

### Five Year Limited Warranty

Part #	Description	Overall Height	Base Stance	Stocking Code	Ship Weight	List Price
BWM12W	12' four legged Becker Windmill Kit	15'	4'-4" sq	62215723	54, 75, 11, 58, 2@49, 16	\$2858.99
BWM16W	16' four legged Becker Windmill Kit	19'	5'-8" sq	32472244	54, 75, 11, 58, 2@49, 43, 16	\$3189.99
BWM20W	20' four legged Becker Windmill Kit	23'	7'-0" sq	82557491	54, 75, 11, 58, 3@49, 43, 16	\$3299.99
BWM20DLX	20' four legged Becker Windmill Deluxe Kit*	23'	7'-0" sq	22712497	54, 75, 11, 58, 4@49, 43, 25	\$3499.99



\*Deluxe Kit contains 2-way splitter, 50' poly, 200' QuickSink tubing and 2 single head QuickSink diffusers

## BECKER WINDMILLS Windmill Head Only

A Division of EasyPro Pond Products™

Already have a windmill tower or want to build your own tower?

- Available in a kit that includes tubing and diffuser(s), or as head only.
- Long-lasting, reinforced neoprene diaphragm
- 6' diameter head with 12 blades operates in wind as low as five miles per hour
- Produces 2.4-5 cfm (depending on air speed) for ponds up to 40' deep
- Over speed protection — tail section will turn head in high winds preventing over spinning
- Can effectively aerate ponds up to two acres depending on shape and depth
- Windmills can sit up to 1000' away from pond's edge — use poly tubing sold in our Lake & Pond Management catalog

### Five Year Limited Warranty

Windmill Head Kit Includes

- Functional head
- QS2 Diffuser
- Fittings
- 50' poly tubing
- 100' of 1/2" QuickSink tubing



Part #	Description	Size	Stocking Code	Ship Weight	List Price
BWMH	Functional windmill head	72" dia	41635246	54, 75, 11, 58, 2@49, 16	\$2109.99
BWMHW	Functional windmill head kit	72" dia	81782413	54, 75, 11, 58, 2@49, 43, 16	\$2299.89





# Lake & Pond Aeration



Sound Shield now included in select Sentinel Kits - Look for the blue shield.



SINCE 1970



Aerate up to **1 acre**

One diffuser systems designed for ponds up to 50' deep

Aerate up to: 1/4 acre at 5'-8' deep    1/2 acre at 8'-12' deep    1 acre at 12'-16' deep



PA34W

## PA34 One Diffuser Systems

- 1/4 hp Stratus SRC Gen 2 compressor with two year warranty
- Outlet assembly with pressure relief
- 100' of 3/8" QuickSink tubing for systems shown
- Typical operation cost of \$0.40 per 24 hours at .09¢ per kWh, actual cost may vary



PA34D

## Sentinel

Sentinel Deluxe Systems include a lockable steel cabinet with compressor, airlines, plumbing, pressure gauge, cooling fan and electrical outlet installed.

- Either SC18 - 18" ground/post mount or SC22 - 22" ground cabinet
- Cabinet now includes pre-installed sound proofing

SC18 Post Mount Option



Part #	Description	Compressor	Diffuser	3/8" QuickSink Tubing	Approx. Air per Diffuser	Cabinet	Stocking Code	Ship Weight (lbs.)	List Price
PA34W	Basic System	SRC25	(1) QS1	100'	2.3 cfm	—	8682496	34	\$909.99
PA34DP	Sentinel Deluxe System	SRC25SS	(1) QS1	100'	2.3 cfm	SC18	51180416	38, 34	\$1570.59
PA34D	Sentinel Deluxe System	SRC25SS	(1) QS1	100'	2.3 cfm	SC22	61398674	63, 29	\$1861.59

All kits 115v, add "2" behind part number for 230v motor



Aerate up to **2 acres**

Two diffuser systems designed for ponds up to 50' deep

Aerate up to: 1/2 acre at 5'-8' deep    1 acre at 8'-12' deep    2 acres at 12'-16' deep

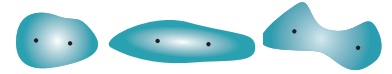

PA34-2

## PA34-2 and PA65 Two Diffuser Systems

- Stratus SRC Gen 2 compressor with two year warranty
- Two valve manifold assembly with pressure relief
- Tubing purchased separately for PA34-2 systems
- 200' of 3/8" QuickSink tubing for PA65 systems shown
- Typical operation cost:  
PA34-2: of \$0.40 per 24 hours at .09¢ per kWh, actual cost may vary  
PA65: of \$0.86 per 24 hours at .09¢ per kWh, actual cost may vary



PA65W



PA65D

## Sentinel

Sentinel Deluxe Systems include a lockable steel cabinet with compressor, airlines, plumbing, pressure gauge, cooling fan and electrical outlet installed.

- Either SC18 - 18" ground/post mount or SC22 - 22" ground cabinet
- Cabinet now includes pre-installed sound proofing

SC18 Post Mount Option



Part #	Description	Compressor	Diffuser	3/8" QuickSink Tubing	Approx. Air per Diffuser	Cabinet	Stocking Code	Ship Weight (lbs.)	List Price
PA34-2	Basic System	SRC25	(2) QS1	—	1.1 cfm	—	7742496	36	\$989.99
PA34-2DP	Sentinel Deluxe System	SRC25SS	(2) QS1	—	1.1 cfm	SC18	51245217	42, 19	\$1,656.99
PA34-2D	Sentinel Deluxe System	SRC25SS	(2) QS1	—	1.1 cfm	SC22	51463476	63, 19	\$1,947.99
PA65W	Basic System	SRC50	(2) QS2	200'	2.2 cfm	—	41094996	25, 70	\$1,459.99
PA65DP	Sentinel Deluxe System	SRC50SS	(2) QS2	200'	2.2 cfm	SC18	31635215	46, 70	\$2,176.99
PA65D	Sentinel Deluxe System	SRC50SS	(2) QS2	200'	2.2 cfm	SC22	41853477	69, 70	\$2,467.99

All kits 115v, add "2" behind part number for 230v motor

Two year warranty on Stratus SRC series compressor, five year warranty on tubing, diffusers and cabinets. Available as basic and Sentinel deluxe systems.





Aerate up to **3** acres

Three diffuser systems designed for ponds up to 50' deep

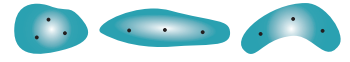

Aerate up to: 3/4 acre at 5'-8' deep    1 1/2 acres at 8'-12' deep    3 acres at 12'-16' deep



PA66W



PA83W

### PA66 and PA83 Three Diffuser Systems

- Stratus SRC Gen 2 compressor with two year warranty
- Three valve manifold assembly with pressure relief
- 300' of 3/8" QuickSink tubing for systems shown
- Typical operation cost:  
PA66: of \$0.86 per 24 hours at .09¢ per kWh, actual cost may vary  
PA83: of \$1.10 per 24 hours at .09¢ per kWh, actual cost may vary



PA83D

### Sentinel

Sentinel Deluxe Systems include a lockable steel cabinet with compressor, airlines, plumbing, pressure gauge, cooling fan and electrical outlet installed.

- SC18 - 18" ground/post mount or SC22 - 22" ground cabinet for PA66 systems
- SC22 - 22" ground cabinet for PA83 systems
- Cabinet now includes pre-installed sound proofing



SC18  
Post Mount  
Option

Part #	Description	Compressor	Diffuser	3/8" QuickSink Tubing	Approx. Air per Diffuser	Cabinet	Stocking Code	Ship Weight (lbs.)	List Price
PA66W	Basic System	SRC50	(3) QS2	300'	1.5 cfm	—	71342498	38, 25, 69	\$1789.99
PA66DP	Sentinel Deluxe System	SRC50SS	(3) QS2	300'	1.5 cfm	SC18	81887965	46, 33, 69	\$2513.99
PA66D	Sentinel Deluxe System	SRC50SS	(3) QS2	300'	1.5 cfm	SC22	42106226	69, 33, 69	\$2804.99
PA83W	Basic System	SRC75	(3) QS2	300'	2.1 cfm	—	81544996	29, 69, 33	\$2059.99
PA83D	Sentinel Deluxe System	SRC34SS	(3) QS2	300'	2.1 cfm	SC22	72446725	70, 69, 33	\$3258.99

All kits 115v, add "2" behind part number for 230v motor



Aerate up to **4** acres

Four diffuser systems designed for ponds up to 50' deep



Aerate up to: 1 acre at 5'-8' deep    2 acres at 8'-12' deep    4 acres at 12'-16' deep



PA86W

### PA86 Four Diffuser Systems

- 3/4 hp Stratus SRC Gen 2 compressor with two year warranty
- Four valve manifold assembly with pressure relief
- 600' of 3/8" QuickSink tubing for systems shown
- Typical operation cost of \$1.10 per 24 hours at .09¢ per kWh, actual cost may vary



PA86D

### Sentinel

Sentinel Deluxe Systems include a lockable steel cabinet with compressor, airlines, plumbing, pressure gauge, cooling fan and electrical outlet installed.

- SC22 - 22" ground cabinet for PA86 systems
- Cabinet now includes pre-installed sound proofing

Part #	Description	Compressor	Diffuser	3/8" QuickSink Tubing	Approx. Air per Diffuser	Cabinet	Stocking Code	Ship Weight (lbs.)	List Price
PA86W	Basic System	SRC75	(4) QS2	600'	1.6 cfm	—	41942497	33, 44, 69, 69	\$2589.99
PA86D	Sentinel Deluxe System	SRC34SS	(4) QS2	600'	1.6 cfm	SC22	62839728	73, 44, 69, 69	\$3782.99

All kits 115v, add "2" behind part number for 230v motor



Two year warranty on Stratus SRC series compressor, five year warranty on tubing, diffusers and cabinets. Available as basic and Sentinel deluxe systems.

**EasyPro® manufactures diffused aeration systems from simple, basic systems to complete, deluxe systems. See our full line in our Lake & Pond Catalog. Contact us for more information!**



## AquaFountain™ 1/2 hp & 1 hp AquaFountains™

Beautiful • Reliable • Affordable



Rocket Nozzle

Light kit sold separately on page 143



Wide Umbrella Nozzle



Narrow Umbrella Nozzle  
(Sold Separately)

For over 25 years AquaFountains have proven themselves to be reliable, affordable and attractive!

- Long lasting, energy efficient motor designed for continuous duty operation, with built in thermal and over current protection
- Floats are made from high density foam and protected by a decorative float cover
- Intake screens are aluminum and prevent leaves, algae, sticks, etc. from plugging pump
- 30" minimum operating depth
- 115v units come with timer and GFI; 230v units include timer only, purchase GFI locally
- Pre-assembled and ready to install

Fountains include rocket and umbrella nozzles. Purchase narrow umbrella separately below.

2 Year Warranty



GFI with timer included on all 115v models

230v units now include timer only panel, without GFI

Part #	hp	Power Cord Length/Gauge	Voltage/Amps	Rocket Spray Dimensions	Wide Umbrella Spray Dimensions	Stocking Code	Ship Weight	List Price
<b>1/2 hp, 115v</b>								
AF50	1/2	100'/12 ga.	115/7.0	8' H x 2' dia.	6' H x 15' dia.	41394993	59 lbs.	\$1799.99
AF5015	1/2	150'/12 ga.	115/7.0	8' H x 2' dia.	6' H x 15' dia.	81549995	67 lbs.	\$1999.99
AF5020	1/2	200'/10 ga.	115/7.0	8' H x 2' dia.	6' H x 15' dia.	12069242	102 lbs.	\$2669.99
<b>1 hp, 115v</b>								
AF100	1	100'/12 ga.	115/11.0	16' H x 5' dia.	8' H x 26' dia.	61704997	82 lbs.	\$2199.99
AF10015	1	150'/10 ga.	115/11.0	16' H x 5' dia.	8' H x 26' dia.	42169996	110 lbs.	\$2799.99
AF10020	1	200'/10 ga.	115/11.0	16' H x 5' dia.	8' H x 26' dia.	32386997	125 lbs.	\$3079.99
<b>1 hp, 230v</b>								
AF1002*	1	100'/12 ga.	230/5.5	16' H x 5' dia.	8' H x 26' dia.	81704996	78 lbs.	\$2199.99
AF100215*	1	150'/12 ga.	230/5.5	16' H x 5' dia.	8' H x 26' dia.	21782496	90 lbs.	\$2299.99
AF100220*	1	200'/12 ga.	230/5.5	16' H x 5' dia.	8' H x 26' dia.	51937497	98 lbs.	\$2499.99
AF100225*	1	250'/12 ga.	230/5.5	16' H x 5' dia.	8' H x 26' dia.	52092495	106 lbs.	\$2699.99
SCFNU	Narrow umbrella nozzle only					544992	3 lbs.	\$59.99

\*230 volt fountains only have timer. GFI must be purchased locally.



## AquaShine™ LED Fountain Lights Color Changing Fountain Light Kits

Brilliant color changing lights are sure to make your fountain dazzle long after the sun goes down!

- Stainless steel 17 watt lights have both true warm white diodes and color changing diodes
- Quick connect plugs on controller, cables and lights for easy assembly. Each light has a 2' pigtail.
- Stainless steel mounting brackets and hardware
- Weather resistant digital timer/controller with remote control makes selecting a color and adjusting the brightness easy.
- Remote control works up to 1000' away!
- Red, green, blue, warm white, lavender, cyan and yellow-green solid colors plus several pre-programmed sequences with additional colors.
- 4 and 6 light kits available. Call for details.

**3 Year Warranty**



Shown with the Aqua Fountain™ Narrow Umbrella Fountain sold on page 142



3 Light Kit  
Shown on Kasco  
1 hp Fountain



2 Light Kit  
Shown on EasyPro® 1 hp  
AquaFountain™

Part #	Description	Power Cord	Stocking Code	Ship Weight	List Price
<b>RGB2-100</b>	2 RGBW LED Light Kit for fountains up to 3/4 hp	100'	6968742	16, 12 lbs.	\$1249.99
<b>RGB2-150</b>	2 RGBW LED Light Kit for fountains up to 3/4 hp	150'	41084992	16, 18 lbs.	\$1399.99
<b>RGB2-200</b>	2 RGBW LED Light Kit for fountains up to 3/4 hp	200'	21201248	16, 23 lbs.	\$1549.99
<b>RGB3-100</b>	3 RGBW LED Light Kit for fountains up to 2 hp	100'	81239992	18, 12 lbs.	\$1599.99
<b>RGB3-150</b>	3 RGBW LED Light Kit for fountains up to 2 hp	150'	61317497	18, 18 lbs.	\$1699.99
<b>RGB3-200</b>	3 RGBW LED Light Kit for fountains up to 2 hp	200'	71433747	18, 23 lbs.	\$1849.99

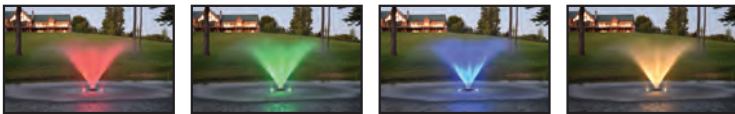

Shown on the Kasco 1 hp Fountain

**2, 3, 4 and 6 Light Kits designed for use with**  
 Kasco 1/2-5 hp Fountains - See our Lake & Pond Catalog  
 EasyPro® AquaFountains™ - page 142  
 EasyPro® AquaFloat™ Floating Fountain Heads - See our Lake & Pond Catalog  
 Work well with most common fountains.  
 Slight on-site hardware modification may be needed.

## AquaShine™ LED Fountain Lights Stainless Steel Warm White Light Kits

All stainless steel fixtures and mounting brackets

**3 Year Warranty**

These kits replace our previous SLK fountain lights and feature a number of upgrades.

- 11 watt stainless steel lights have quick-connect power cords - longer cord lengths are available
- Weather resistant digital timer/controller with built-in voltage regulator can be used with cords up to 300'.
- All power cords, splitters and lights can be changed or replaced easily using modular quick connect components. Each light has a 2' pigtail.
- 4 and 6 light kits available. Call for details.

Part #	Description	Power Cord	Stocking Code	Ship Weight	List Price
<b>WFL2-100</b>	2 LED Light Kit for fountains up to 3/4 hp	100'	4697498	11, 12 lbs.	\$899.99
<b>WFL2-150</b>	2 LED Light Kit for fountains up to 3/4 hp	150'	7767243	11, 18 lbs.	\$989.99
<b>WFL2-200</b>	2 LED Light Kit for fountains up to 3/4 hp	200'	7836992	11, 23 lbs.	\$1079.99
<b>WFL3-100</b>	3 LED Light Kit for fountains up to 2 hp	100'	3875743	14, 12 lbs.	\$1129.99
<b>WFL3-150</b>	3 LED Light Kit for fountains up to 2 hp	150'	8960997	14, 18 lbs.	\$1239.99
<b>WFL3-200</b>	3 LED Light Kit for fountains up to 2 hp	200'	21038491	14, 23 lbs.	\$1339.99







## Cutrine-Plus® Liquid

- A chelated copper algaecide that is safer to use than copper sulfate
- Use for surface or suspended algae
- Apply by sprayer to surface, for best results use with activator (see below)

### DOSAGE RATE<sup>†</sup>

0.6 to 3 gallons per  
acre-foot

Part #	Description	EPA Registered	Case Quantity	Stocking Code	Ship Weight	List Price
CPL	Cutrine-Plus Liquid, 1 gallon	Yes	4	952792	12 lbs.	\$65.99



## Cutrine Plus® Granular

- The granular form of Cutrine
- For bottom filamentous algae: 20 to 60 pounds per surface acre
- For chara: 30 to 90 pounds per surface acre

### DOSAGE RATE<sup>†</sup>

20 to 90 pounds per  
surface acre

Part #	Description	EPA Registered	Case Quantity	Stocking Code	Ship Weight	List Price
CPG1	Cutrine Granular, 12 lb. jug	Yes	4	654395	14 lbs.	\$67.99
CPG3	Cutrine Granular, 30 lb. bag	Yes	3	3111191	32 lbs.	\$138.99



## Cutrine® Ultra Liquid

- Ideal for thick walled filamentous algae, colonial planktonic algae and chara
- No water use restrictions
- Dilute and apply by sprayer for best results
- Surfactant/activator mixed in already — no need for additional mixing



### DOSAGE RATE<sup>†</sup>

0.6 to 3 gallons per  
acre-foot

Part #	Description	EPA Registered	Case Quantity	Stocking Code	Ship Weight	List Price
CPLU25*	Cutrine Ultra, 2.5 gallons	Yes	2	567673	26 lbs.	\$84.59

\*Must ship as hazardous material with additional charges via UPS or motor freight.



## Hydrothol®

- This granular is a fast acting, contact herbicide effective on a variety of aquatic weeds including milfoil, coontail, hydrilla, sago pondweed, leafy pondweed, curly leaf pondweed and others. Use as a spot treatment early in the season when plants are young and easier to treat.

### DOSAGE RATE<sup>†</sup>

108-270 pounds per  
acre-foot

Part #	Description	EPA Registered	Case Quantity	Stocking Code	Ship Weight	List Price
HYD20	Hydrothol granular, 20 lb. bag	Yes	2	6111997	22 lbs.	\$139.99
HYD40	Hydrothol granular, 40 lb. box*	Yes	—	7214399	43 lbs.	\$267.99

\*40 lb. box contains two 20 lb. bags



## Propeller®

### Fast acting, contact aquatic herbicide

- Controls selected submersed, emergent and floating aquatic weeds. Most effective when applied to young, actively growing weeds in water with a pH of less than 8.5.
- A new treatment option at a time when herbicide resistance, variable response and environmental concern issues loom large
- Ideal for duckweed, watermeal, Eurasian milfoil and water lettuce
- Non-corrosive, fine granule – mix with water to apply. Active ingredient is 51% Flumioxazin.

### DOSAGE RATE<sup>†</sup>

6 to 12 oz. per acre  
for duckweed/watermeal  
1.1 to 2.1 lbs. per acre-foot  
for submersed plants

Part #	Description	EPA Registered	Case Quantity	Stocking Code	Ship Weight	List Price
PRP1	Propeller aquatic herbicide, 1 lb.	Yes	4	981137	2 lbs.	\$98.69
PRP5	Propeller aquatic herbicide, 5 lbs.	Yes	4	7317692	6 lbs.	\$383.49

No shipment to AK, CA, CT, ID, HI, ME, MA, NH, NY, RI, VT, WA & Canada



<sup>†</sup>Always refer to label for exact manufacturer's dosage rates and instructions.

## See what's new at EasyPro.com

We're always expanding our lineup of quality water features and pond and lake equipment. Learn about the latest additions here. Browse through our expansive product catalog to find the pond solutions you need.



**Promotional Materials / Catalogs** - Find our most current catalogs, manuals, sell sheets, product data sheets, SDS sheets and more.

**Search/Where to Buy/FAQs** - Search for articles, content or products by model number, keyword or specs. Find locations where you can buy EasyPro® products as well as get answers to questions asked.

**Videos** - See our pond supplies in action with product demos, installations and instructional videos. Follow the link to our YouTube channel. We're adding more video content often - check it out!

**Inspiration Gallery** - Use this inspiration gallery to help visualize the possibilities for your next water feature/pond design project.

**And More** - Create pond, pump or Just-A-Falls™ calculations, limited warranty information and how to contact us for anything else you may need.

**Download promotional pieces, manuals and SDS sheets from [www.easypro.com/resources](http://www.easypro.com/resources) or your Resource Portal**

## "How To" Series Articles

Download and share any of our "How To" Series Articles to help educate your customers on products, pond problems, pond assembly and other pond related issues. Here is just a sampling of what you'll find:

- Basalt Features - Beautiful and Easy
- How to Select the Right Pond Pump
- Building Koi Caves and Tunnels
- Pond Aeration for All Seasons
- How to Install a Bottom Drain
- Diagnosing Ailing Ponds
- Diagnosing Water Loss - Leak or Evaporation?
- Steps for Winterizing Your Pond
- Pond Lighting
- Offset Reservoir System - The Ultimate Guide
- Understanding Bacteria & Enzymes
- Guide to Backyard Pond Water Quality
- Guide to Lake and Pond Water Quality



### Digital Promotion

EasyPro.com • Social Media Sharable "How To" Articles

## Social Media

Creating fresh content to share with your customers on social media can be a challenge. We can help! We can help you show your customers that you carry quality EasyPro® products.

We have created a library of pre-made EasyPro® posts with suggested wording that you can easily copy and paste right into your own Social Media posts. Use the wording as-is, mix it up or use your own content. Ask us for the Dropbox link by emailing [christy@easypro.com](mailto:christy@easypro.com).

### SHARE YOUR SUCCESS!

Your success stories are our success stories and we love to see them! **Tag us in your posts** so we can see your awesome work and share your posts, promoting your business. Teamwork makes the dream work!

Want to share your work with us but not into social media? Simply email your photos or videos to [info@easypro.com](mailto:info@easypro.com) and include a brief description and what products you used in your project. If we're able to use your photos, we'll make sure that you get all the credit!





## Promotional Materials

Catalogs • Guides  
Sell Sheets • Brochures



View digital catalog here

## EasyPro® Brand Catalogs

Request a print version OR download the digital version from [EasyPro.com](http://EasyPro.com) of our most current catalogs.

### Pond & Water Feature Catalog • WC

This catalog contains products and information on all your needs for ornamental ponds and water features.



### Lake & Pond Management • WCL

This catalog contains products and descriptions for all of our water treatments, fountains, aeration systems and aquaculture supplies for lakes and ponds.

**New!**

## FREE Brochures (Digital or Print)

Inspiring and educate your customers. High quality printed brochures are great leave-behind tools to keep you in your customers' minds. PDF versions are available in your [resource portal](#) for sharing digitally, or add the printed versions to your next order.

For higher quantities, please contact us for details.

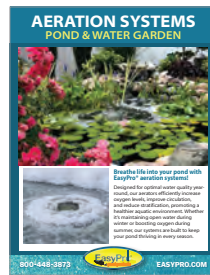

PAWG  
Pond & Water Garden  
Aeration



TDB  
Tranquil Décor



VFS  
Vianti Falls

## FREE Data Sheets (Digital Only)

Available for download: We offer a variety of digital data sheets, SDS sheets and more on [easypro.com](http://easypro.com) or in your [resource portal](#). Just download and print to use as handouts. These are a more in-depth look at EasyPro® products and are great resources to share.



Download digital promotional pieces, manuals and SDS sheets from your [resource portal](#)



SINCE 1970

# EasyPro Promotional Materials

## EasyPro® Branded Promos



Increase sales and inspire your customers with visual merchandising. Full-color banners are perfect for in-store displays and trade shows!

## FREE Retractable Banners

34" x 83" • Includes pull-up stand and soft-sided carry case

New Designs!



BN36G Water Gardening



BN36F Water Features



BN36L Lake & Pond Management



## Branded Promotions

EasyPro® Branded Materials:  
Banners • Displays

## FREE Wall Banners

24" x 48"

13 oz. vinyl • with corner grommets

New Designs!



BN2402 - EasyPro 3 Photo



BN2403 - Tranquil Décor

New Designs!

## FREE Aisle Banners

16" x 24" • 13 oz. vinyl • with corner grommets



BN1201 Vianti Falls



BN1202 TH Pumps



BN1203 Treatments



BN1204 Axiom



BN1205 Just-A-Falls



BN1206 Pond Kits



BN1207 Pond Tents



BN1208 KLC Aeration



BN1209 Pond-Vive



BN1210 Pond Dyes



BN1211 Sludge Remover



BN1212 Sentinel Aeration



BN2405 - Lake & Pond Sold Here

New banner designs will be available when our current stock of the older designs is depleted.



## A

### Aeration & Supplies

Pond & Water Garden .....	64-70
Lake & Pond.....	130, 134-137
Airline, Weighted PVC.....	70
Air Diffusers .....	64, 69
Algaecide.....	80-81, 140
All-In-One Filter.....	83
AquaFalls Replacement Parts & Rock Grate.....	38
Aqua Ultra Violet Ultima II Filters.....	93
Aquatic Planting Media.....	81
Auto Fill Valves.....	20, 45
Auto Fill, Wall Mount .....	124

## B

Bacteria .....	74, 78-79, 82, 132-133
Bags, Fish Shipping.....	47
Bags, Media .....	34, 92
Ball Valves.....	118
Bander Tool & Bands.....	47
Barley Straw.....	75
Basalts.....	4-15
Basins.....	17-19
Bead Filters .....	88-89, 93
Bio Balls Filter Media .....	90
Bio-Blox Filter Media .....	91
Black Waterfall Foam.....	39
Bog Filters.....	37
Bottom Drains & Kits .....	46
Boulder Covers .....	70
Bronze Fountain Nozzles .....	125-128
Bulk Water Treatments.....	78-79
Bulkhead Fittings.....	119

## C

Cam Lock Fittings.....	117
Check Valve Assemblies.....	44

Check Valves, PVC.....	119
Chlorinator.....	124
Compressors .....	64, 66-68
Compressor Parts .....	64, 67-68, 134
Couplers, Rubber .....	117

## D

Debris Nets, Skimmers.....	34
Defoamer.....	77
De-icer/Heater, Pond.....	61
Diffusers.....	64, 69
Disease Treatments, Fish.....	81

## E

EasyWeave Pond Liner.....	59
Eco-Clear Filters.....	84-85
Eco-Clear Pumps.....	98
Edge Sealant .....	58

## F

Fill Valves, Water.....	20, 45
Filter Brushes.....	91
Filter Floss Bio-Media.....	90
Filter Pads, Waterfall .....	38
Filter, Pump Intake .....	92, 111
Filter Mats, Skimmer .....	34
Filter Media.....	90-92

### Filters

All-In-One.....	83
Bog .....	37
Cartridge.....	123
Eco-Clear .....	84-85
Pressurized & Bead...84-85, 88-89, 93	
Skid Mount .....	89, 123
Ultima II.....	93
Waterfalls.....	35-37
Fish Display Systems .....	120
Fish Food .....	48
Fish Shipping Bags.....	47

Fish Treatments .....	81
Fittings.....	114-119
Flanges.....	110, 129
Flexible PVC Pipe .....	112
Flow Meter .....	102, 119
Foam, Black Waterfall.....	39
Formal Fountain.....	121-129
Formal Fountain Chlorinator.....	124
Fountain, AquaFountain .....	138
Fountain, Starburst Mini .....	66
Fountain Basins .....	17-19
Fountains, Tranquil Décor .....	4-15

## H

High Strength Reservoir Cubes.....	27
------------------------------------	----

## I

Intake Filters & Stands .....	92, 111
-------------------------------	---------

## J

Junction Boxes .....	129
Just-A-Falls Kits.....	28-29

## K

Kink-Free Tubing.....	113
Koi Food.....	48

## L

Lake & Pond Products.....	130-140
Lids, Skimmers.....	34
Lights .....	16, 49-55, 129, 139
Liner .....	56-57, 59
Liner, Accessories.....	58
Liner, Air Vent.....	60
Liner, Pond Shield.....	60
Liner, Underlayment.....	57
Liner, Underliner Vent System.....	60

## M

Marketing Materials.....	141-143
Matala Biological Pre-filter .....	92
Matala Filter Media .....	92

Matala Pond Vacuums .....61  
 Media Bags .....34, 92  
 Meter, Salinity .....71  
 Microbe-Lift..... 80-82

**N**

Net, Telescoping Pond .....47  
 Netting, Pond..... 62-63  
 Nozzles, Bronze ..... 126-128  
 Nozzles, PVC .....127, 138

**O**

Ordering Information..... 146-147  
 Outlet Assemblies, Pump .....44

**P**

PH Down/PH Up .....77  
 PH Tester .....71  
 Phosphate Binder ..... 75, 133  
 Pond Cover Netting ..... 62-63  
 Pond Dye ..... 77, 79, 131  
 Pond Heater/De-Icer .....61  
 Pond Kits..... 40-43  
 Pond Liner ..... 56-57, 59  
 Pond Net, Telescoping .....47  
 Pond Salt.....72  
 Pond Shield.....60  
 Pond Tents.....63  
 Pressurized Filters.....84-85, 88-89, 93  
 Promotional Materials ..... 141-143  
 Pump Outlet Assemblies .....44  
 Pump Pro-Tectors .....47  
 Pump Screen ..... 111  
 Pump Vaults & Extension .....26  
 Pump, Self-Priming .....107, 109  
 Pumps, External ..... 106-110  
 Pumps, Mag Drive ..... 16, 95-98  
 Pumps, Submersible..... 16, 94-104  
 PVC Fittings ..... 114-119

PVC Flexible Pipe ..... 112  
 PVC Primer/Glue ..... 115

**R**

Real Stone Fountains .....4-15

**Replacement Parts**

AquaFalls .....36  
 Cartridge Filters..... 123  
 Compressors ..... 64, 66-68  
 Eco-Series Waterfalls .....35  
 Filter Pads, Waterfalls .....38  
 Lights .....54  
 Pumps.....97, 98  
 Skimmers.....34  
 UV..... 33, 85-86, 93

Reservoir Cubes .....27  
 Return, Bronze Eyeball..... 124  
 Rock Covers .....70  
 Rock Grate, AquaFalls.....38

**S**

Salinity Meter .....71  
 Screens/Protectors  
 Submersible ..... 47, 95, 111  
 Scuppers, Wall.....22  
 Silicone Sealant.....39  
 Skid Mount Systems..... 89, 123  
 Skimmers.....30-34, 124  
 Skimmer Replacement Parts .....34  
 Skimmers, Wall ..... 124  
 Skimmers, Weir .....34  
 Spring/Summer Cleaner .....81  
 Spillways ..... 21-25  
 Stainless Steel UV .....87, 93  
 Starburst Mini Fountain .....66  
 Statuary Basins ..... 17-19  
 Statuary Fountains & Kits.....4-15  
 Statuary Accessories..... 16

Submersible Filter w/UV .....83  
 Submersible Pump Screen..... 111  
 Suction Strainers..... 116

**T**

Tanks ..... 120  
 Test Kits .....71  
 Thermometer, Pond.....71  
 Tranquil Décor .....4-16  
 Transformer, Low Voltage.....55  
 Trash Pump, Submersible.....99  
 Tubing, Kink-Free..... 113  
 Tubing, PVC ..... 112  
 Tubing, Self-Weighted .....70  
 Tubing, Vinyl ..... 113

**U**

Underliner Vent System .....60  
 UV Clarifier/Sterilizer .....33, 87, 93  
 UV Lights .....33, 87, 93  
 UV Light, Skimmer .....33

**V**

Vacuum, Pond.....61  
 Valve Boxes ..... 117  
 Vaults, Pump .....26  
 Vianti Falls ..... 20-22

**W**

Wall Scuppers .....22  
 Water Clarifier .....77, 79  
 Water Conditioner .....76, 79  
 Waterfall Diffusers .....23  
 Water Fill Box.....45  
 Water Fill Valves.....45  
 Water Testing .....71  
 Water Treatments .....72-82, 132-133  
 Waterfall Installation Kit.....39  
 Weir, Skimmers .....34





## Where to Buy

EasyPro Pond Products are available across the U.S. and Canada through our growing network of distributors and dealers. Purchasing EasyPro items through these local suppliers has become the easiest and most cost effective choice for landscape professionals and homeowners. Use the "Where to Buy" section on our website or contact us at 800-448-3873 and we can help you find an EasyPro supplier near you.



## Customer Service

**Technical Assistance** 2024 marked our 54th year in the aquatics business. We feel it is better to spend time helping you properly select products now rather than spend time with you later helping to solve the problems (and expense) of incorrect products! Please feel free to contact us for free design assistance on pond, waterfall, aeration, filtration, etc. Whenever possible, please send us a diagram of your layout to provide us a visual reference. Fax your diagram to 231-834-5537 or email to [quotes@easypro.com](mailto:quotes@easypro.com).

**Large Orders** If you are in need of a large quantity of an item (or items), please provide us a list of items and quantities needed so we can quote you prices.

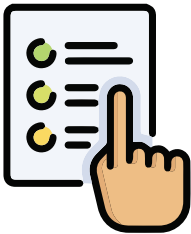

## Ordering

For your convenience there is a PDF order form in your **resource portal**. This order form may be filled out electronically and submitted by email or fax.

Place orders in any of the following ways:

**Telephone** Orders by phone can be placed at 231-834-7720 or toll free at 800-448-3873; Monday to Friday; 8am to 5pm Eastern time.

**Fax** Orders by fax can be sent to 231-834-5537

**Email** orders to [orders@easypro.com](mailto:orders@easypro.com). This email is for orders only. For special project quote requests (ponds, Just-A-Falls, fountains, aeration, etc.) email to [quotes@easypro.com](mailto:quotes@easypro.com). For any other questions, quotes or services, please call us at 800-448-3873.



## Shipping Information

**Items Less Than 150 Pounds** These items typically ship UPS or Fed-Ex. As shipping fees and calculations change frequently from carriers, we strive to provide economical, on time and secure delivery of product. From time to time additional carrier fees are charged for bulky items (filter material, pond kits, etc.), unpackaged goods (i.e. flex pipe, kink-free tubing, etc.), hazardous goods and other special considerations.

**Large and/or heavy items are shipped motor freight** Last year, we achieved another record by shipping more than **3 million pounds** of freight over truck lines. Because of our large volume, we have negotiated higher discounts with our truck lines from their standard rates. This makes us very competitive when shipping large orders. Motor freight companies charge a residential fee when delivering to a residence.

**Damaged Shipments Please inspect your shipment before signing for it!** Once you sign for your shipment, the carrier will not be liable for shortages or damage. You can refuse a damaged shipment or accept it with clear notification of damage on the bill of lading. Please call us immediately if you refuse a damaged order so we can accept it back from the carrier and reship your order.



## Returns

**All returns must have an RA#** (Return Authorization Number). This lets us know what is coming back and what to do with it (i.e. credit your account, replace product, etc.). A 10% restock fee will apply to returns unless it is our shipment error. Packages sent to us without an RA# written on them will be refused. All products, including warranty items, must be returned to us shipping prepaid. We will pay the shipping charges on warranty items back to you, but not from you to us. Product over 90 days old is not returnable for credit. Special orders, cut liner and used items are not returnable.

**Obtain a Return Authorization ("RA") number** by calling EasyPro at 800-448-3873 or via email at [warranty@easypro.com](mailto:warranty@easypro.com).



## Payment Options

**Credit Cards** We accept VISA, MasterCard, Discover and American Express.

**Money Orders/Checks** Money orders or business checks are accepted as payment.

**Net 30 Account** Companies wishing to set up an account with us need to fill out our credit application. Schools, institutions and governmental agencies are pre-approved with use of a purchase order number. Interest will accrue on all invoices over 30 days. No orders will be shipped to customers with invoices over 60 days old until account is brought current.



## Hours

**Business Hours** Monday through Friday, 8:00 a.m. to 5:00 p.m. EST  
**Sales, marketing, shipping and office closed Saturdays and Sundays.**

**We will be closed for the following 2025 holidays**

- Good Friday — Friday, April 18
- Memorial Day — Saturday, May 24 and Monday, May 26
- Independence Day (US) — Friday, July 4
- Labor Day — Saturday, August 30 and Monday, September 1
- Thanksgiving (US) - Thursday, November 27 and Friday, November 28
- Christmas - Wednesday, December 24 through Thursday, January 1



## Warranty

EasyPro honors all manufacturers' warranties. Each manufacturer has their own warranty procedure. Some manufacturers allow us to determine warranty for them, while others handle their own warranties. Submersible pumps that have been run out of water, have been altered or have cuts to the power cord will not be covered by warranty. Also, any product not used for its intended purpose, altered, damaged, improperly maintained or neglected will not be covered. Submersible pumps cannot be taken apart, this voids warranty. Shipping costs to us (or to the manufacturer) are not covered by warranty, please insure package when shipping back to us. If product is covered by warranty we will pay shipping costs to ship new/repaired item back to you. Product returned to us for warranty that is deemed in working condition will be shipped back to you at your expense. Be sure your electrical supply is proper before returning pumps to us — each year we get numerous returns that are in good working order only to find the problem was in the electrical supply! A bench fee of \$25.00 will be charged for each pump returned to us that is not broken. Each year we test hundreds of pumps, many of which are fine. This fee covers time and materials used in testing pumps that are in good working order.

***A policy of continuous improvement is our goal, therefore products may change from these shown. All prices are subject to change without notice. We make every effort to maintain printed prices however, due to circumstances out of our control, they may change.***





4385 East 110th  
Grant, MI 49327

231-834-7720  
800-448-3873  
Fax: 231-834-5537

info@easypro.com  
www.easypro.com

Issued January 2025  
**Catalog #55W**

Current Resident or

## Two Specialized Catalogs!



We're proud to offer the largest selection of products in the industry. Whether a small water feature or a large lake, we have products for nearly every application. We know your time is valuable. So you can focus on the products you need, we publish two catalogs.

- **The Pond & Water Feature catalog** contains products and information on recreational swim ponds, ornamental ponds and water features.
- **The Lake & Pond Management catalog** contains all of our water treatments, fountains, aeration systems and aquaculture supplies.

Please contact us via phone or website to view or request copies of our catalogs!

